

GENERAL CATALOG

MILLING

we improve, we evolve, we **ADD**

JosS
◦

JosS d.o.o.
Sokolska 45, 2000
Maribor, Slovenia
+386 2 421 57 20
+386 41 705 509
joss@joss.si
www.joss.si

2025





Tungaloy's Insights – Smart Manufacturing

Tungaloy, as one of the leaders in the metal removal industry, offers the latest innovations in grades and geometries for superb performance and tool life.

*Tungaloy's latest
innovations in cutting
tools contribute to
carbon neutrality*



VOL. 2 MILLING

A	Grade	A001 -
B	Insert	B001 -
C	External Toolholder	C001 -
D	Internal Toolholder	D001 -
E	Threading Tool	E001 -
F	Parting, Grooving	F001 -
G	Miniature Machining	G001 -
H	Milling Cutter	H001 -
I	Endmill	I001 -
J	Drilling Tool	J001 -
K	Tooling System	K001 -
L	User's Guide	L001 -
M	Alphanumeric Index	M001 -

About Tunggaloy Cutting Tool Catalog

Note in using this catalog:

- ★ This catalog provides the information of Tunggaloy's cutting tools as of March 2023.
- ★ The specifications are subject to change without prior notice for product improvements. Also, the products may be discontinued in the future due to the development of new products.
- ★ The dimensions of all products are shown in millimeters (mm).
- ★ For indexable tools, such as toolholders, cutters, drill bodies, applicable inserts or heads need to be ordered separately.

How to use this catalog:

The image shows a navigation flow through the catalog. On the left, a 'VOL. 2 MILLING' menu lists categories like Grade, Insert, External Toolholder, Internal Toolholder, Threading Tool, Parting, Grooving, Miniature Machining, Milling Cutter (H001), Endmill (I001), Drilling Tool (J001), Tooling System (K001), User's Guide (L001), and Alphanumeric Index (M001). Red boxes and numbers 1, 2, and 3 highlight the 'Milling Cutter' and 'Endmill' categories, the 'H001' and 'I001' codes, and the 'Alphanumeric Index' respectively. The main content area shows detailed technical drawings and tables for '4-flute endmill, shank type, for 4-corner double sided inserts' and '4-flute endmill, modular type (tungsten)'. A table of designations and specifications is provided for both types. On the right, an 'INSERT' section shows 'LNMSU2-MM (for general purpose)' with a table of designations and specifications. Red boxes and numbers 1, 2, and 3 highlight the 'INSERT' section, the 'LNMSU2-MM' designation, and the 'M001' alphanumeric index.

- 1 Select the tool category at the product group index.
- 2 Select the tool type at the application index on the left pages.
- 3 The index is in the alphanumerical order. Use it for your product search.

How to read the list for the standard items:

- ★ Designations for indexable tools – cutter bodies, holders, etc.
 - Orders are to be received for the tools with the designations in the catalog.
 - For the tool with right- and left-hand options, the designation includes ****R/L**** as shown below.
 - Ex. 1: Designation: TENO9**R**/L125M38.1-10
You can order both right- and left-hand tools. TENO9**R**125M38.1-10 (a right-hand tool) and TENO9**L**125M38.1-10 (a left-hand tool) will be available.
 - Ex. 2: Designation: TENO9**R**100M31.7-05
You can order only right-hand tools. Please contact us when you need left-hand tools.
- ★ Lineup for inserts, endmill heads, and solid tools
Blank : Please contact us regarding the product.

About Tungaloy Cutting Tool Catalog

Icons at the left side of each page

External toolholder (cutting edge shape / angle)

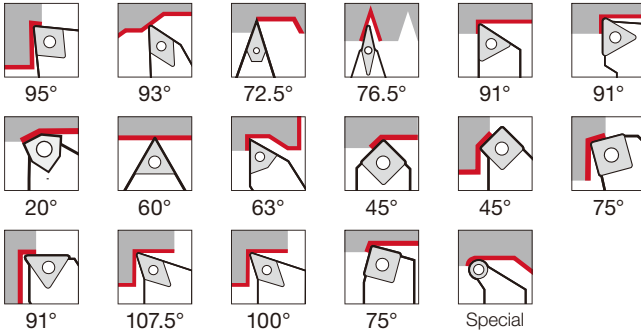

Internal toolholder (cutting edge shape / angle)

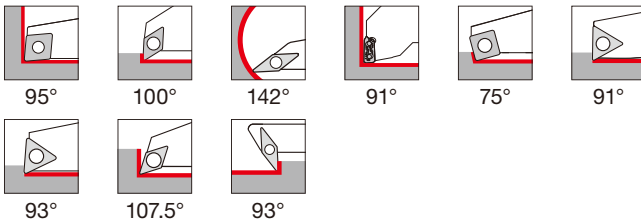

Parting, Grooving

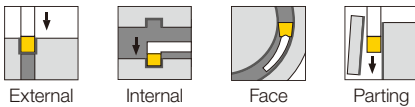

Miniature machining

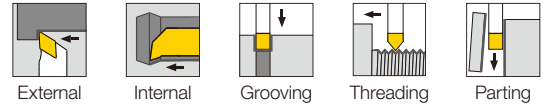

Mill

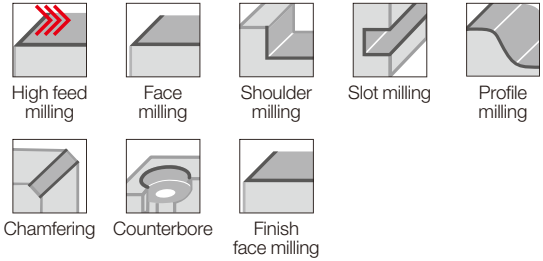

Endmill

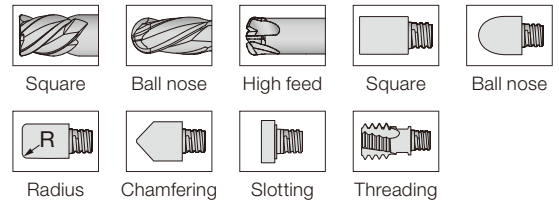

Drill

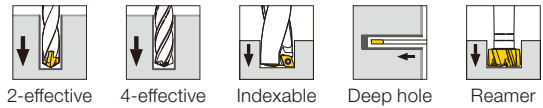

Icons for applications of each product

Threading

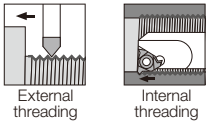

Grooving

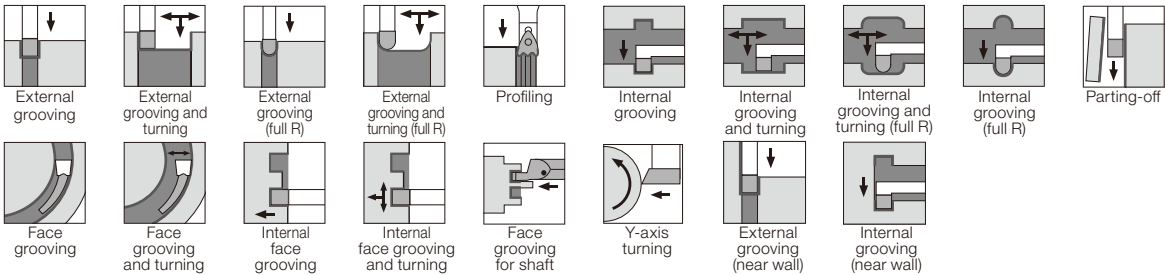

Milling

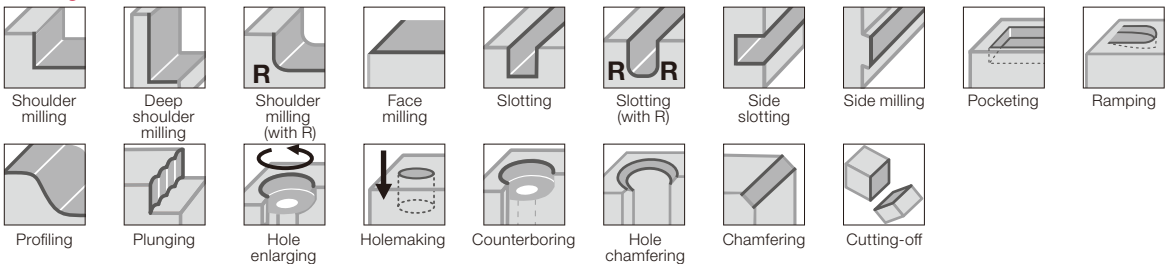

Drilling



About the dimension symbols conforming to ISO13399

■ What is ISO13399?

ISO13399 is an international standard for the purpose of standardizing the electronic data of tools in the world.

■ Switching to the dimension symbols conforming to ISO13399

In this catalog, we use the dimension symbols (properties) conforming to ISO13399 international standard.

Below are the examples of the change.

■ Examples of the change:

	Before	After
Insert		
Turning		
Milling		
Drilling		

ISO13399 standardizes not only the format of 2D and 3D CAD data but also the tool dimension symbols (properties) and reference position information. This allows the tool information to be read and combined into NC programs and CAM software, regardless of any tool maker's data. In addition to General Catalog (paper catalog), we are also updating the symbols in e-catalog (electronic catalog on our website) to the properties conforming to ISO13399. The e-catalog also provides 2D and 3D CAD data in accordance with ISO13399 standard.

■ Insert

New symbol	Old symbol	Description
AN	-	Main cutting edge relief angle
APMX	Max. ap	Maximum depth of cut
AS	A	Side cutting edge relief angle
BW	B	Body width
BS	bs	Side cutting edge (wiper) length
CDX	T max	Maximum groove depth
CW	W	Grooving edge width
D1	ød1	Mounting hole diameter
DCONMS	øDs	Mounting part diameter on the machine
DMIN	øDm	Minimum machining diameter
EPSR	-	Nose angle
GAN	-	Rake angle (insert)
IC	ød	Inscribed circle diameter
INSD	A	Insert diameter (round type)
INSL	B	Insert length
KAPR	κ	Approach angle
LBB	-	Chipbreaker width
LE	A	Effective cutting edge length
LF	L1	Standard length
M	m	Distance from inscribed circle to cutting edge (m dimension)
PDX	t	Thread position (X direction)
PDY	ℓ3	Thread position (Y direction)
PNA	θ	Cutting edge angle
PSIRL	θ	Left-hand front cutting edge angle
PSIRR	θ	Right-hand front cutting edge angle
RE	r	Corner radius
S	T	Thickness
W1	-	Insert width

■ Turning, Grooving

New symbol	Old symbol	Description
B	b	Shank width
BD	øD1, øD2, øD3	Body external diameter
CDX	ar	Maximum groove depth
CND	-	Oil hole diameter
CNT	-	Oil hole plug size
CUTDIA	øDmax	Maximum parting diameter
CW	W	Grooving edge width
CWN	-	Minimum grooving edge width
CWX	-	Maximum grooving edge width
DAXN	øDm	Minimum diameter in face grooving
DAXX	øDmax	Maximum diameter in face grooving
DCONMS	øDs	Mounting part diameter on the machine
DCONWS	øD, ød2	Mounting part diameter on the workpiece
DMIN	øDm	Minimum machining diameter
GAMF	α	Radial rake angle
GAMP	θ	Axial rake angle
H	h	Shank length
HBH	h2	Height of offset on the bottom of head
HBKL	f2	Length of uneven level on the back of head
HBKW	L2	Width of uneven level on the back of head
HBL	L2	Length of offset on the bottom of head
HF	h1	Standard height
KAPR	κ	Approach angle
LB	L	Body length
LF	L1	Standard length
LH	L2	Head length
OAH	h4	Overall height
OAL	L1	Overall length
OAW	L3	Overall width
PSIR	β	Lead angle
WB	-	Body width
WF	f	Standard width
WFS	f2	Standard width (the second corner)

About the dimension symbols conforming to ISO13399

■ Tooling system

New symbol	Old symbol	Description
APMX	Max. ap	Maximum depth of cut
BD	$\varnothing D1, \varnothing D2, \varnothing D3$	Body external diameter
BHTA	α	Neck taper angle (half of nose angle)
BTED	$\varnothing d1$	Taper tip diameter
CRKS	S	Mounting screw size
DBC	$\varnothing d3$	Bolt hole pitch diameter
DCONMS	$\varnothing Ds$	Mounting part diameter on the machine
DCONWS	$\varnothing D, \varnothing d2$	Mounting part diameter on the workpiece
DMIN	$\varnothing Dm$	Minimum machining diameter
GAMF	$\alpha, R.R.$	Radial rake angle
GAMP	$\theta, A.R.$	Axial rake angle
KAPR	κ	Cutting edge angle
LB	L2, L3	Body length
LF	L	Standard length
LPR	L1	Parting length
LS	ℓs	Shank length
LSC	Lmin	Clamp length
LSCX	Lmax	Maximum clamp length
OAH	H4	Overall height
OAL	L	Overall length
OAW	W	Overall width
THID	-	Mounting screw size
WB	W	Body width
WF	f	Standard width

■ Drilling

New symbol	Old symbol	Description
BD	$\varnothing D1, \varnothing D2, \varnothing D3$	Body external diameter
CND	-	Oil hole diameter
CNT	-	Oil hole plug size
CRKS	S	Mounting screw size
DC	$\varnothing Dc$	Machining diameter
DCONMS	$\varnothing Ds$	Mounting part diameter on the machine
DCONWS	$\varnothing D, \varnothing d2$	Mounting part diameter on the workpiece
DSCFMS	$\varnothing D$	Connecting part diameter
KAPR	κ	Cutting edge angle
LCF	ℓ	Flute length
LF	Lf	Standard length (from the drill shoulder)
LPR	-	Parting length (from flange to tip)
LS	ℓs	Shank length
LU	ℓ	Machinable depth
NOF	z	Number of flutes
OAL	L	Overall length (from tip)
PL	PL	Distance from drill tip to shoulder
ZEFP	Z eff	Number of effective cutting edges on periphery

■ Milling

New symbol	Old symbol	Description
APMX	Max. ap	Maximum depth of cut
BD	$\varnothing D1, \varnothing D2, \varnothing D3$	Body external diameter
BHTA	α	Neck taper angle (half of nose angle)
CBDP	ℓ	Mounting hole depth
CDX	Max. ae	Maximum slot width
CHW	k	Chamfer width on the corner
CICT	z	Number of inserts
CRKS	S	Mounting screw size
CW	W	Slotting edge width
CWN	-	Minimum slotting edge width
CWX	-	Maximum slotting edge width
DBC	$\varnothing d3$	Bolt hole pitch diameter
DC	$\varnothing Dc$	Machining diameter
DCONMS	$\varnothing d$	Mounting part diameter on the machine
DCONWS	$\varnothing D, \varnothing d2$	Mounting part diameter on the workpiece
DSCFMS	$\varnothing Db$	Mounting surface diameter on the machine
DCX	$\varnothing Dc1$	Maximum machining diameter
GAMF	R.R.	Radial rake angle
GAMP	A.R.	Axial rake angle
H	T	Width across flat
KAPR	κ	Cutting edge angle
KWW	a	Drive key width
LF	Lf	Standard length
LH	Lf	Neck length
LS	ℓs	Shank length
NOF	z	Number of flutes
OAL	L, L6	Overall length
PDX	t	Thread position (X direction)
PNA	θ	Cutting edge angle
PSIR	β	Lead angle
RMPX	θ	Maximum ramping angle
THUB	T	Hub height (slot mill)
WT	Kg	Weight
ZEFP	Z eff	Number of effective cutting edges on the periphery

Note:

- Symbols unspecified in ISO13399 standard and Tungaloy's original symbols are not included.
- The symbols still under discussion are included. Please note any change or addition may occur.

■ CAD data provided in e-catalog

● 2D data (DXF format file)

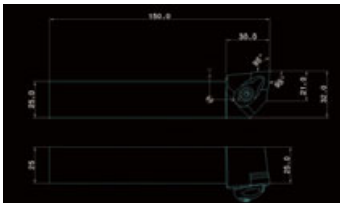

Turning:
Shows the insert with standard corner radius.

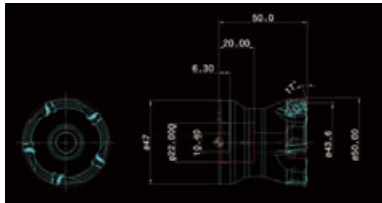

Milling:
Includes actual cutting edge curve (CUT layer) and body cross section (NOCUT layer).

● 3D data Light type (STP format file): Can be used to check tool path and interference.

Turning: Equipped with an insert with a standard corner radius.

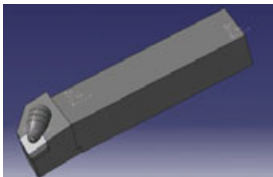

Milling: A rotating body model of an actual cutting edge curve and a body cross section.



● 3D data Detail type (STP format file): Can be used to create a new tool layout chart. (Can be combined with any insert model on a CAD software.)

Turning

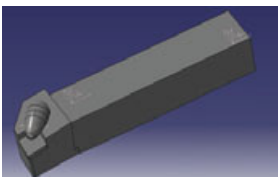

Milling



Milling Cutter



Milling Cutter - Content structure

- Products are listed by application.
- Please refer the table of contents and the icons.

How to use the page

Method ①

Select the application (①) and the approach angle (②) at the left end of each page and choose a designation you need (⑤) in the dimension table (④). Applicable inserts are shown in (⑧).

The screenshot shows the ADDFEED EXN02 product page. On the left, there are icons for applications (1) and approach angles (2). The main content includes a technical drawing of the tool, a dimension table (4) with columns for Designation, APMX, D, C, DC, DCSFMS, OAL, LF, H, KAPR, CRKS, WTi, Air hole, and Insert. A table of applicable inserts (8) is also shown. The bottom section shows the HXNO product page with similar information.

Method ②

Select the tool series name on **H006 - H007** and check the details on the product page.

The Application Overview page lists several milling applications with their respective tool series and page numbers:

- Face Milling** (H006 page): DCTMILL, DCPENT, TUNGE MILL.
- For aluminum milling**: TUNGE MILL, TUNGE-ALUMILL.
- High-Feed Milling** (H018 page): ADDFEED, DOFEED, DCFTRI, MILLOFEED.
- Profile Milling** (H192 page): FIXRMILL, ADDFBÄRREL, TUNGE MASTER, BALLFINOSE.

Method ③

Select the tool series or the tool specification on **H006 - H017** and see the details on each page.

The High-Feed Milling - Quick Guide table provides a comparison of tool series across various parameters:

	TUNGE	ADDFEED	DOFEED	DCFTRI	DOFMILL
Cutting edge angle	12°	17°	10° / 12° / 15° / 17°	12°	20° / 25°
Depth of cut (mm)	0.5	0.5	0.9 / 1.1 / 1.5	-	1.5 / 2
Tool diameter	ø6 - ø16	ø6 - ø20	ø16 - ø20	ø16 - ø20	ø20 - ø25
Workpiece material	Al, Cu, H	Al, Cu, H	Al, Cu, H	Al, Cu, H	Al, Cu, H
No. of corners	2	4	4	5	4
Face milling	★	★	★	★	★
Shoulder milling	★	★	★	★	★
Profile milling	★	★	★	★	★
Slot milling	★	★	★	★	★
Other applications	★	★	★	★	★
Reference groups	H038 - H041	H020 - H023	H024 - H037	H042 - H045	H046 - H050

Legend: ★ Most suitable, ☆ Suitable, ○ Suitable

Icon

Approach angle

	7° ~ 25°
	41° ~ 45°
	60° ~ 70°
	85° ~ 88°
	90°

Application

	Thin workpiece
	Ramping
	Long overhang
	Axial plunging
	Hole enlarging
	Slot milling

	Deep shoulder milling
	Face milling
	External threading
	Back facing
	Peck milling
	Hollow workpiece
	Deep slot milling

	Shoulder milling
	Internal threading
	Profiling
	Edging / Contouring
	Interrupted surface
	Cutting off
	Chamfering

3 ADD FEED EXN02
 High feed endmill, strain type, for 4-corner double sided inserts

6

Designation	APMX	DCX	CIC1	DC	DCONMS	LF	LH	LS	KAPR	WT(kg)	A hole	Insert
ENK02R08M08-D-01	0.5	8	1	3.95	8	75	16	59	17°	0.02	With	LNMU02...
ENK02R08M08-D-01L	0.5	8	1	3.95	8	90	31	59	17°	0.03	With	LNMU02...
ENK02R10M10-D-02	0.5	10	2	5.85	10	80	20	60	17°	0.04	With	LNMU02...
ENK02R10M10-D-02L	0.5	10	2	5.85	10	100	40	60	17°	0.05	With	LNMU02...
ENK02R12M12-D-02	0.5	12	2	7.8	12	80	20	60	17°	0.06	With	LNMU02...
ENK02R12M12-D-02L	0.5	12	2	7.8	12	110	50	60	17°	0.08	With	LNMU02...
ENK02R16M16-D-04	0.5	16	4	11.8	16	100	30	70	17°	0.14	With	LNMU02...
ENK02R16M16-D-04L	0.5	16	4	11.8	16	120	50	70	17°	0.17	With	LNMU02...
ENK02R20M20-D-04L	0.5	20	4	15.8	20	160	80	80	17°	0.32	With	LNMU02...
ENK02R20M20-D-05	0.5	20	5	15.8	20	130	50	80	17°	0.27	With	LNMU02...
ENK02R25M25-D-07	0.5	25	7	20.8	25	140	60	80	17°	0.46	With	LNMU02...
ENK02R25M25-D-08L	0.5	25	8	20.8	25	180	100	80	17°	0.57	With	LNMU02...

7 SPARE PARTS
 Designation: ENK02R08... ENK02R10... ENK02R12... ENK02R16... ENK02R20... ENK02R25...
 Chamfered insert: CSPB-18FL3.8 IP-4DB
 Flank: CSPB-18FL4.3 IP-4DB
 Tool diameter tolerance: Tool diameter / 0.1-0.4
 Recommended clamping torque: 0.5 N·m

8 INSERT LNMU02-MM (for general purpose)

Material	Steel	Stainless	Cast iron	Non-ferrous	Superalloy	Hard materials
APMX	★	★	★	★	★	★
DCX	★	★	★	★	★	★
RE	★	★	★	★	★	★
IC	★	★	★	★	★	★
S	★	★	★	★	★	★

Designation	RE	APMX	DCX	LE	IC	S
LNMU0202ER-MM	0.0	0.5	2	1.79	4	3.1

10 Reference pages: Standard cutting conditions → H022 - H023, TungFlex → H036 - H037
 H020 joss.si

9 STANDARD CUTTING CONDITIONS

ISO	Workpiece materials	Hardness	Priority	Grades	Cutting speed Vc (m/min)	Feed per tooth fz (mm/rev)
P	Carbon steels S45C, S55C, etc. C45, S55C, etc.	- 300HB	First choice	AH325	100 - 300	0.2 - 1.2
	Alloy steels SCM440, 42CrMo4, etc. 42CrNiMo4, Ti03, etc.	- 300HB	First choice	AH325	100 - 300	0.2 - 1.2
	Prehardened steels NA80, FA5, etc.	30 - 40HRC	First choice	AH815	100 - 200	0.2 - 0.8
M	Stainless steels SUS304, SUS316, etc. X3CrNi18-9, X3CrNiMo17-12-3, etc.	- 200HB	First choice	AH130	100 - 150	0.2 - 0.8
	Gray cast irons FC200, FC300, etc. 200, 300, etc.	150 - 250HB	First choice	AH815	100 - 300	0.2 - 1.2
K	Ductile cast irons FC200, etc. GG-10, etc.	150 - 250HB	First choice	AH815	80 - 200	0.2 - 1.2
	Titanium alloy Ti-6Al-4V, etc.	- 40HRC	First choice	AH130	30 - 60	0.2 - 0.7
S	Heat resistance alloy Inconel, Hastelloy, etc.	- 40HRC	First choice	AH815	20 - 50	0.1 - 0.3
	Hardened steel SKD11, etc. X30CrMoV15-1, etc.	40 - 50HRC	First choice	AH325	80 - 150	0.1 - 0.5
H	Hardened steel SKD11, etc. X30CrMoV15-1, etc.	50 - 60HRC	First choice	AH815	50 - 70	0.1 - 0.3

APPLICATION RANGE

Designation	DCX	APMX	RMPX	A	W	Min. machinable hole dia. øD1	Max. machinable hole dia. øD2	Max. cutting width in enlarged hole øE
E/HN02R08...	8	0.5	1.05	0.15	2	10	13.2	5.87
E/HN02R10...	10	0.5	2.8	0.15	2	13.8	17	7.82
E/HN02R12...	12	0.5	1.9	0.15	2	17.8	21	9.81
E/HN02R16...	16	0.5	1.2	0.15	2	25.8	29	13.8
E/HN02R20...	20	0.5	0.88	0.15	2	33.8	37	17.8
E/HN02M25...	25	0.5	0.66	0.15	2	43.8	47	22.8

H022 joss.si

- 1 : Application
- 2 : Approach angle
- 3 : Tool series name
- 4 : Dimension table
- 5 : Mill designation
- 6 : Dimension drawing (conforming to ISO13399)
- 7 : Spare parts
- 8 : Insert
- 9 : Standard cutting conditions
- 10 : Reference page

Workpiece material

- P Steel

- M Stainless

- K Cast iron

- N Non-ferrous

- S Superalloys

- H Hard material

When ordering

- Please specify the designation and quantity for mills.
e.g. **TPW13R080M25.4-06** ... 1 (one mill per package)
- Please specify the designation, grade, and quantity for inserts.
e.g. **SWMT1304PDPR-MJ AH120** ... 10 (10 inserts per package)
- *You will find a note if the number per package is not 10.

Application Overview

Face Milling

H066 page



For general face milling

DOT^{TRIPLE}MILL

Three times the selection, more than a triple advantage

H085 page

DO^{PENT}

Face milling cutter with low cutting force and low cost per edge

H070 page

TUNG^{EIGHT}MILL

Economical 8 edged inserts with light cutting face milling cutter

H083 page

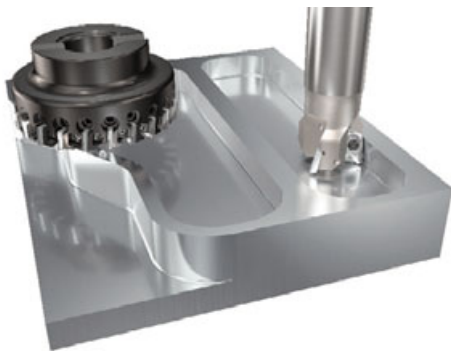

For aluminum milling

TUNG^{SPEED}MILL

High speed face milling cutter for finishing aluminum

H092 page

TUNG-ALUMILL

Shoulder mill that enables high speed machining of aluminum and non-ferrous materials

H160 page

High-Feed Milling

H018 page



ADD^DFEED

Ultimate high feed milling cutter for maximum productivity

H020 page

DO^{FEED}

High-functional HFM cutter demonstrating ultimate versatility in a broad range of applications

H024 page

DO^FTRI

High feed milling cutters with six cutting edge inserts, featuring robust cutter design for high productivity

H042 page

MILL^QFEED

General-purpose high feed milling cutter providing optimal depths-of-cut in all material groups

H057 page

Profile Milling

H192 page



FIX^RMILL

Unique anti-rotation insert locking for maximum process security

H078 page

ADD^{FORCE}BARREL

Highly efficient profile milling cutter for maximum productivity

H198 page

TUNG^{MEISTER}

Exchangeable-head end mill series with a full lineup of milling heads

I060 page

BALL^{FINISH}NOSE

Indexable end mill for high-precision finishing

H193 page

Shoulder Milling

H120 page

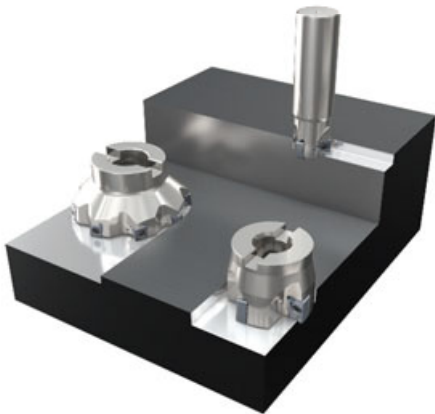
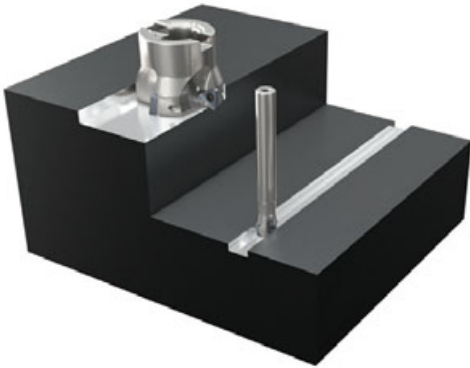

Other Applications

H180 page

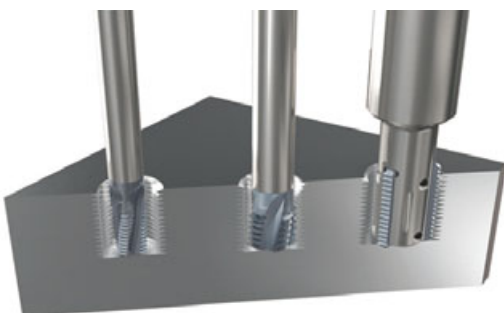
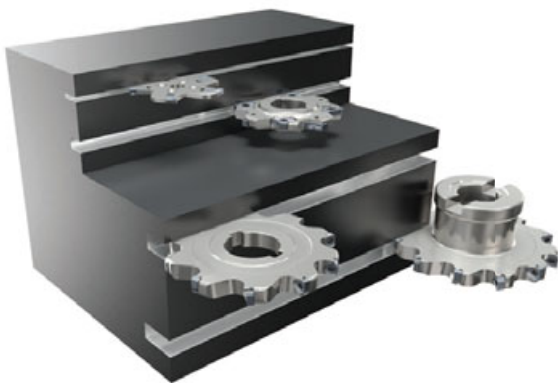

Shoulder milling cutters (with single-sided inserts)

TUNG-TRI

Offers a vast range of cutter diameters, insert grades and sizes. Insert features three economical cutting edges

H130 page

TUNG^{ORCE}FREC

Unique V shape inserts allow extremely aggressive cutting parameters

H122 page

Shoulder milling cutters (with double-sided inserts)

DO^{ORCE}FTRI

Rigid cutter body and double-sided six-edged inserts enable aggressive parameters and cost efficiency

H150 page

DOREC

Double-sided inserts with four cutting edges for maximum tool economy and productivity

H154 page

TECMILL

Exceptionally reliable tangential inserts for aggressive machining

H163 page

Slot Milling

TUNG^MSLIT

Provides stable slot milling operation with excellent chip control

H181 page

TUNG^{THIN}SLIT

Enables deep slot milling with excellent tool economy

H185 page

TUNG^{UNIVERSAL}USLOT

Double-sided insert with six cutting edges for reduced cost per edge

H187 page

TEC^{TANGENTIAL}TSLOT

Incorporates tangential inserts for excellent tool reliability

H189 page

Thread Milling

THREADMILLING

Various types of threads can be machined with a single tool simply by changing the inserts

I124 page

TUNGMEISTER

Exchangeable-head end mill series with a full lineup of milling heads

I060 page

Thread milling cutter SOLIDTHREAD

Economical indexable thread milling cutter series

I107 page

Grade

Insert

Ext. Toolholder

Int. Toolholder

Threading

Grooving

Miniature tool

Milling cutter

Endmill

Drilling tool

Tooling System

User's Guide











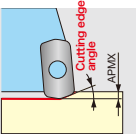



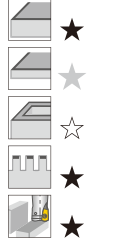
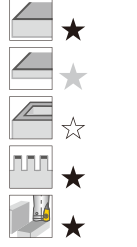
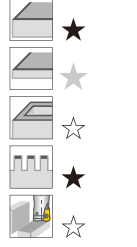

Index

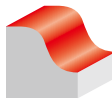
High-Feed Milling - Quick Guide

	TUNGF^{FACE}FEED	ADD^DFEED	DOFEED	DOF^{TRI}	DO^TBALL
Cutting edge angle	12°	17°	10° / 12° / 15° / 17°	12°	20° / 25°
Depth of cut (APMX)	0.5	0.5	0.9 / 1 / 1.5	1	1.3 / 2
Tool diameter	ø8 - ø16	ø8 - ø25	ø16 - ø200	ø16 - ø50	ø20 - ø63
Workpiece material	P M K S H	P M K S H	P M K S H	P M K S H	P M K S H
No. of corners (insert)	2	4	4	6	4
Other applications					
Reference pages	H038 - H041	H020 - H023	H024 - H037	H042 - H045	H046 - H050

★ : Most suitable
 ☆ : Suitable
 ☆ : Usable

Icon





















	MILLFEED TXP	MILLQ^{FEED}	DOFEEDQUAD
			
Cutting edge angle	10° / 15° / 20°	7° / 10° / 12° / 14°	13°
Depth of cut (APMX)	1.5 / 3	1 / 1.5 / 2 / 2.5	2
Tool diameter	ø20 - ø160	ø25 - ø160	ø50 - ø125
Workpiece material	P M K S H	P M K S H	P M K S H
No. of corners (insert)	3	4	8
 Face milling			
 Shoulder milling			
 Profile milling			
 Slot milling			
Other applications			
Reference pages	H051 - H056	H057 - H062	H063 - H065

★ : Most suitable

☆ : Suitable

★ : Usable

Icon

 Thin workpiece	 Ramping	 Long overhang	 Axial plunging	 Hole enlarging	 Slot milling	 Deep shoulder milling
 Face milling	 External threading	 Back facing	 Peck milling	 Hollow workpiece	 Deep slot milling	 Shoulder milling
 Internal threading	 Profiling	 Edging / Contouring	 Interrupted surface	 Cutting off	 Chamfering	



High Feed Milling

Face Milling - Quick Guide



Face Milling



Shoulder Milling



Slot Milling













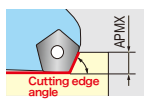









Profile Milling



Chamfering, Counterbore

































Finish Face Milling

	TUNGEMILL	DOPENT	ROUNDSPLIT	FIXRMILL	TUNGEMILL LIGHT
					
Cutting edge angle	45°	70°			41°
Depth of cut (APMX)	4 / 5 / 2	6.4	6 / 8	6	3
Tool diameter	ø25 - ø200	ø32 - ø315	ø32 - ø125	ø40 - ø80	ø50 - ø160
Workpiece material	P M K N	P M K N S H	P M K N S	P M K S H	P M K S H
No. of corners (insert)	4	10	4 / 8	6 / 8	8
Face milling					
Shoulder milling					
Profile milling					
Slot milling					
Other applications					
Reference pages	H068 - H069	H070 - H073	H074 - H077	H078 - H082	H083 - H084

★ : Most suitable
☆ : Suitable
★ : Usable





















Icon

	DO T MILL	DOOCTO	TUNG S MILL		TFE
			TPYP	T/EPYD	
					
Cutting edge angle	45°	45° / 15°	90°	90°	85.5°
Depth of cut (APMX)	6 / 3.4	4.75 / 7.5 / 3.5 / 1.5	4 / 11	4.5 / 7.5	8 / 3.5 / 1.5
Tool diameter	ø50 - ø160	ø63 - ø315	ø50 - ø125	ø50 - ø160	ø63 - ø125
Workpiece material	P M K S H	P M K S H	N	N	P M K N
No. of corners (insert)	8 / 16	8 / 16	1 / 2	1	4 / 1 / 2
 Face milling					
 Shoulder milling					
 Profile milling					
 Slot milling					
Other applications					
Reference pages	H085 - H087	H088 - H091	H094 - H095	H092 - H093	H096 - H099

★ : Most suitable
☆ : Suitable
☆ : Usable

Icon

 Thin workpiece	 Ramping	 Long overhang	 Axial plunging	 Hole enlarging	 Slot milling	 Deep shoulder milling
 Face milling	 External threading	 Back facing	 Peck milling	 Hollow workpiece	 Deep slot milling	 Shoulder milling
 Internal threading	 Profiling	 Edging / Contouring	 Interrupted surface	 Cutting off	 Chamfering	











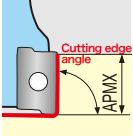









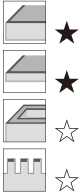

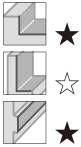



Shoulder milling - Quick Guide

	TUNGFRÄC	TUNG-TRI		TUNGREC	
Shoulder Milling					
Cutting edge angle	90°	90°	90°	90°	90°
Depth of cut (APMX)	4 / 6 / 11.5	3.5 / 6 / 10 / 15	54 - 97 (-139)	7 / 10.6 / 16.7	30.4 - 48.8
Tool diameter	ø6 - ø63	ø8 - ø160	ø50 - ø100	ø12 - ø160	ø25 - ø50
Workpiece material	P M K N S H	P M K N S H	P M K N S	P M K N S H	P M K N S H
No. of corners (insert)	2	3	3	2	2
Face milling					
Shoulder milling					
Profile milling					
Slot milling					
Other applications					
Reference pages	H122 - H129	H130 - H139		H140 - H147	





















★ : Most suitable
☆ : Suitable
★ : Usable

Icon

	TUNGQUAD		DOFRÄI	DOREC	TUNGSMILL EPYP
		Roughing 			
Cutting edge angle	90°	90°	90°	90°	90°
Depth of cut (APMX)	4	20.3 - 24.2	6.5 / 11	9 / 16	4 / 11
Tool diameter	ø12 - ø40	ø20 - ø25	ø18 - ø160	ø25 - ø160	ø25 - ø32
Workpiece material	P M K N S H	P M K N S H	P M K S	P M K S H	N
No. of corners (insert)	4	4	6	4	1 / 2
Face milling 					
Shoulder milling 					
Profile milling 					
Slot milling 					
Other applications					
Reference pages	H148 - H149		H150 - H153	H154 - H157	H095, H158

★ : Most suitable
☆ : Suitable
★ : Usable

Icon

 Thin workpiece	 Ramping	 Long overhang	 Axial plunging	 Hole enlarging	 Slot milling	 Deep shoulder milling
 Face milling	 External threading	 Back facing	 Peck milling	 Hollow workpiece	 Deep slot milling	 Shoulder milling
 Internal threading	 Profiling	 Edging / Contouring	 Interrupted surface	 Cutting off	 Chamfering	







Shoulder milling - Quick Guide

	DOQ^{AP}MILL	TECMILL		TUNG^{SH}TSHRED	
Cutting edge angle	88°	90° / 60°	90°	90°	90°
Depth of cut (APMX)	9.5	9.7 / 15.1 / 12.4	58.5 / 66.9	16	61 - 76
Tool diameter	ø50 - ø100	ø32 - ø250	ø50 - ø63	ø50 - ø100	ø63 - ø80
Workpiece material	P M K S H	P M K S H	P M K S H	P M K S H	P M K S H
No. of corners (insert)	8	4	4	3	3
	★ ★ ☆ ☆	★ ★ ☆ ★ ☆	★ ★ ★ ★ ☆	☆ ★ ★ ☆ ★	★ ★ ★ ☆ ★
		★ ☆ ★	★ ☆ ☆	★ ★ ☆	☆ ★ ☆
				★ ★	★ ★
		☆			
Reference pages	H158 - H159	H163 - H166		H170 - H171	

★ : Most suitable
 ☆ : Suitable
 ☆ : Usable

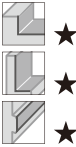
Icon





















TUNG-ALUMILL	
	
Cutting edge angle	90°
Depth of cut (APMX)	13 - 16
Tool diameter	ø25 - ø125
Workpiece material	N
No. of corners (insert)	2
 Face milling	
 Shoulder milling	
 Profile milling	
 Slot milling	
Other applications	
Reference pages	H160 - H162

★ : Most suitable

☆ : Suitable

★ : Usable

Icon

 Thin workpiece	 Ramping	 Long overhang	 Axial plunging	 Hole enlarging	 Slot milling	 Deep shoulder milling
 Face milling	 External threading	 Back facing	 Peck milling	 Hollow workpiece	 Deep slot milling	 Shoulder milling
 Internal threading	 Profiling	 Edging / Contouring	 Interrupted surface	 Cutting off	 Chamfering	



Slot milling - Quick Guide

	TUNGMSLIT	TUNG ^{MIN} SLIT	TUNG ^{UNIVERSAL} SLOT	TECT ^{ESSENTIAL} SLOT
Depth of cut (W)	1.6 - 4.1	4 - 8	9 - 16	16 - 25
Tool diameter	ø63 - ø125	ø80 - ø200	ø80 - ø160	ø100 - ø250
Workpiece material	P M K	P M K S	P M K S	P M K S
No. of corners (insert)	1	6	6	4
Face milling				
Shoulder milling				
Profile milling				
Slot milling				
Other applications				
Reference pages	H181 - H184	H185 - H186	H187 - H188	H189- H190

★ : Most suitable
 ☆ : Suitable
 ☆ : Usable

Icon

Thin workpiece	Ramping	Long overhang	Axial plunging	Hole enlarging	Slot milling	Deep shoulder milling
Face milling	External threading	Back facing	Peck milling	Hollow workpiece	Deep slot milling	Shoulder milling
Internal threading	Profiling	Edging / Contouring	Interrupted surface	Cutting off	Chamfering	

Profile milling - Quick Guide

	BALL F ^{NOSE}	ADD F ^{BÄRREL}	DO M ^{INI MILL}	BALL R ^{NOSE}	DO T ^{WIST BALL}
Depth of cut (APMX)	12.5	-	1	11.8 / 13.6 / 17.7	4 / 5 / 6
Tool diameter	ø8 - ø32	ø16 - ø40	ø16 - ø25	ø16 - ø25	ø20 - ø63
Workpiece material	P M K S H	P M K S H	P H	P M K S H	P M K S H
No. of corners (insert)	1	4	6	2	4
 Face milling					
 Shoulder milling					
 Profile milling					
 Slot milling					
Other applications					
Reference pages	H193 - H197	H198 - H199	H200	H201 - H202	H046 - H050

★ : Most suitable
☆ : Suitable
☆ : Usable

Icon

Grade

Insert

Ext. Toolholder

Int. Toolholder

Threading

Grooving

Miniature tool

Milling cutter

Endmill

Drilling tool

Tooling System

User's Guide

Index

Chamfering and Counterboring - Quick Guide











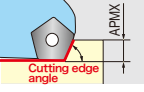





- High Feed Milling
- Face Milling
- Shoulder Milling
- Slot Milling
- Profile Milling
- Chamfering, Counterbore
- Finish Face Milling

	Chamfering cutter TUNGQUAD	Chamfering cutter ECP	Chamfering cutter ECC	Counterboring endmill TCB	DOM^{ULTI}REC
Cutting edge angle	45°	45°	30°, 45°, 60°	90°	90°
Depth of cut (APMX)	3	6	14.5 / 20.5 / 25.5	4 / 5 / 6 / 8 / 10	7 / 9 / 11
Tool diameter	ø12 - ø22	ø27.5 - ø53.3	ø34 - ø55	ø10 - ø59	ø16 - ø26
Workpiece material	P M K N S	P K	P M K	P M K N S H	P M K S H
No. of corners (insert)	4	4	2	4	4
					☆ ☆ ☆ ☆ ★
					☆ ☆ ☆
					☆ ★ ★
					☆ ☆
Other applications	★	★	★	★	★ ★
Reference pages	H210 - H212	H213	H214 - H215	H216 - H220	H221 - H223

★ : Most suitable
 ☆ : Suitable
 ☆ : Usable











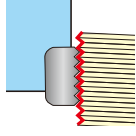

Icon

Face Milling - Quick Guide

	NMS	MS	SFP
			
Cutting edge angle	-	-	-
Depth of cut (APMX)	0.2	0.1	0.1
Tool diameter	ø80 - ø200	ø100 - ø300	ø100 - ø200
Workpiece material	P M K	P H	P M K N
No. of corners (insert)	4		
 Face milling	 ★  ☆  ☆  ☆	 ★  ☆  ☆  ☆	 ★  ☆  ☆  ☆
Reference pages	H232 - H233	H234 - H235	H235 - H236





















★ : Most suitable
 ☆ : Suitable
 ☆ : Usable

Thread milling - Quick Guide

	SOLIDTHREAD	TUNGMEISTER	THREADMILLING E TTL	THREADMILLING Thread milling cutter
				
Pitch	0.25 - 3.5	0.5 - 4.5	1.5 - 3	1.5 - 6
Tool diameter	ø0.7 - ø20	ø10 - ø21.7	ø17 - ø30	ø23 - ø80
Workpiece material	P M K S	P M K S	P M K S	P M K
No. of corners (insert)	-	-	2	2
Thread milling	 ★  ★	 ★  ★	 ★  ★	 ★  ★
Reference pages	I107 - I123	I060 - I105	I124 - I127	I128 - I129

★ : Most suitable
 ☆ : Suitable
 ☆ : Usable

Icon

 Thin workpiece	 Ramping	 Long overhang	 Axial plunging	 Hole enlarging	 Slot milling	 Deep shoulder milling
 Face milling	 External threading	 Back facing	 Peck milling	 Hollow workpiece	 Deep slot milling	 Shoulder milling
 Internal threading	 Profiling	 Edging / Contouring	 Interrupted surface	 Cutting off	 Chamfering	





ADD^oFEED / DOFEED



Ultimate high feed milling cutter series for maximum productivity

ADD^oFEED

Insert size 02



Max. depth of cut: 0.5 mm
Tool diameter: ø8 - ø25 mm

- ✓ Tool diameters as small as **8 mm**
- ✓ **Highly reliable design**
- ✓ Perfect option for **replacing solid end mills**

DOFEED

Insert size 03



Max. depth of cut: 0.9 mm (UER), 1 mm (ZER)
Tool diameter: ø16 - ø50 mm

- ✓ **Close pitch cutter design** for high productivity
- ✓ **Extensive lineup** for various applications
- ✓ **New UER inserts with small approach angle** for long tool life

DOFEED

Insert size 06



Max. depth of cut: 1.5 mm
Tool diameter: ø32 - ø200 mm

- ✓ **Close pitch cutter design** for high productivity
- ✓ Tool diameters available for up to 200 mm, ideal for **rough milling of medium- and large-sized components**
- ✓ **Wiper inserts** for improved surface roughness

Tool diameters and number of teeth for each insert size

Insert size	Max. depth of cut (mm)	Workpiece material	Tool diameter (mm), Number of teeth																					
			ø8	ø10	ø12	ø16	ø18	ø20	ø22	ø25	ø28	ø30	ø32	ø35	ø40	ø50	ø52	ø63	ø66	ø80	ø100	ø125	ø160	ø200
02	0.5	P M K S H	1	2	2	4		5		7														
03	0.9 (UER) 1 (ZER)	P M K S H				2	2	4	4	5	5	5	5	5	5									
06	1.5	P M K S H										2	2	3	4	4	4	4	5	6	6	8	10	12

Reference pages: **H020 - H037**

Cutter body design for maximum productivity

Extremely stiff body design with a large core



Reliable and economical inserts

Economical double-sided inserts with four cutting edges

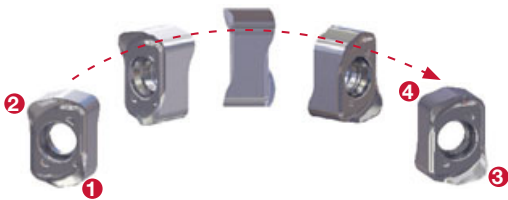

Thick insert design for increased reliability

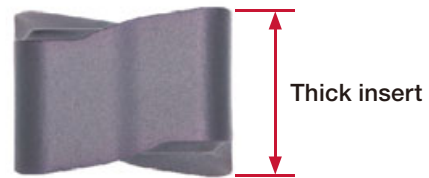

Soft cutting geometry with superior chip control

Comparison of spindle load

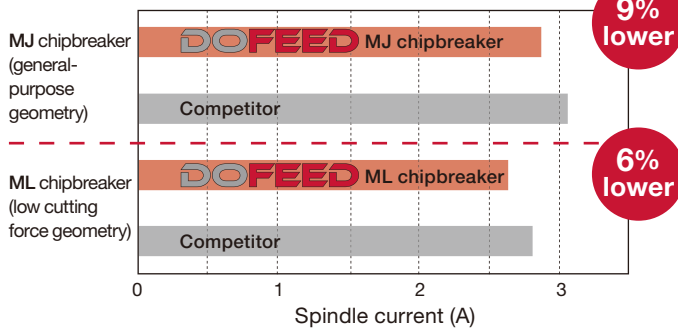

P Cutter : EXN03R025M25.0-05 ($\phi 25$ mm, $z = 5$)
 Insert : LNMU0303ZER-MJ / ML AH725
 Workpiece material : S55C / C55
 Cutting speed : $V_c = 250$ m/min
 Feed per tooth : $f_z = 0.5$ mm/t
 Depth of cut : $a_p = 0.5$ mm
 Width of cut : $a_e = 25$ mm (Slot milling)
 Coolant : Dry
 Machine : Vertical M/C, BT40

Note: Test cut using a single insert

Provides stable, high productivity due to the excellent chip evacuation

Forms compact chips



	DOFEED	Competitor
Chip shapes		
Shoulder surfaces after grooving operations		

High feed endmill, shank type, for 4-corner double sided inserts

GAMP = +6°, GAMF = +5° ~ +11°

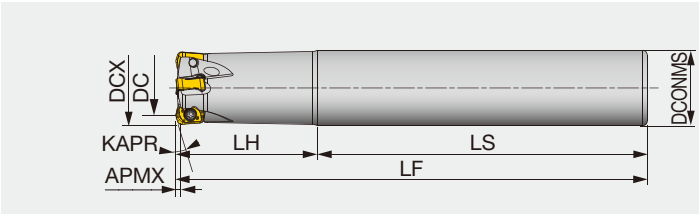

Designation	APMX	DCX	CICT	DC	DCONMS	LF	LH	LS	KAPR	WT(kg)	Air hole	Insert
EXN02R008M08.0-01	0.5	8	1	3.95	8	75	16	59	17°	0.02	With	LNMU02...
EXN02R008M08.0-01L	0.5	8	1	3.95	8	90	31	59	17°	0.03	With	LNMU02...
EXN02R010M10.0-02	0.5	10	2	5.85	10	80	20	60	17°	0.04	With	LNMU02...
EXN02R010M10.0-02L	0.5	10	2	5.85	10	100	40	60	17°	0.05	With	LNMU02...
EXN02R012M12.0-02	0.5	12	2	7.8	12	80	20	60	17°	0.06	With	LNMU02...
EXN02R012M12.0-02L	0.5	12	2	7.8	12	110	50	60	17°	0.08	With	LNMU02...
EXN02R016M16.0-04	0.5	16	4	11.8	16	100	30	70	17°	0.14	With	LNMU02...
EXN02R016M16.0-03L	0.5	16	3	11.8	16	120	50	70	17°	0.17	With	LNMU02...
EXN02R020M20.0-04L	0.5	20	4	15.8	20	160	80	80	17°	0.32	With	LNMU02...
EXN02R020M20.0-05	0.5	20	5	15.8	20	130	50	80	17°	0.27	With	LNMU02...
EXN02R025M25.0-07	0.5	25	7	20.8	25	140	60	80	17°	0.46	With	LNMU02...
EXN02R025M25.0-06L	0.5	25	6	20.8	25	180	100	80	17°	0.57	With	LNMU02...

HXN02

High feed endmill, modular type (TungFlex)

GAMP = +6°, GAMF = +5° ~ +11°

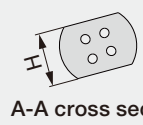
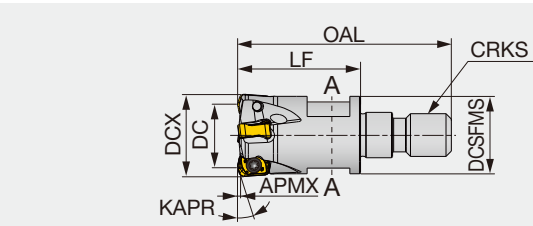

Designation	APMX	DCX	CICT	DC	DCSFMS	OAL	LF	H	KAPR	CRKS	WT(kg)	Air hole	Insert
HXN02R008MM06-01	0.5	8	1	3.95	9.5	33.5	19	7	17°	M6	0.01	With	LNMU02...
HXN02R010MM06-02	0.5	10	2	5.85	9.5	31.5	17	7	17°	M6	0.01	With	LNMU02...
HXN02R012MM06-02	0.5	12	2	7.8	10	31.5	17	7	17°	M6	0.01	With	LNMU02...
HXN02R016MM08-04	0.5	16	4	11.8	14.5	40	23	10	17°	M8	0.03	With	LNMU02...
HXN02R020MM10-05	0.5	20	5	15.8	17.8	49	30	15	17°	M10	0.06	With	LNMU02...
HXN02R025MM12-07	0.5	25	7	20.8	23	52	30	17	17°	M12	0.1	With	LNMU02...

Approach angle

7°-25°

41°-45°

60°-70°

85°-88°

90°

Others

SPARE PARTS

Designation	Clamping screw	Wrench
EXN02R008..., HXN02R008...	CSPB-1.8FL3.6	IP-6DB
EXN02R010... - EXN02R025... HXN02R010... - HXN02R025...	CSPB-1.8FL4.3	IP-6DB

Tool diameter tolerance	
Tool diameter	0 / -0.4

Recommended clamping torque: 0.5 N·m

Reference pages: Standard cutting conditions → **H022 - H023**, TungFlex → **H036 - H037**

INSERT

LNMU02-MM (for general purpose)

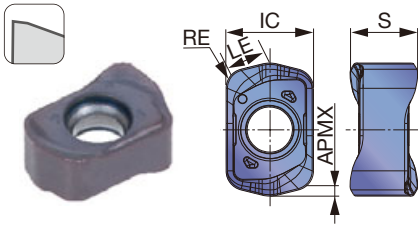

P	Steel		★	☆							
M	Stainless	★	☆								
K	Cast iron		☆	★							
N	Non-ferrous										
S	Superalloy	★		★							
H	Hard materials		☆	★							

★ : First choice
☆ : Second choice

Designation	RE	APMX	Coated									LE	IC	S	
			AH130	AH3225	AH8015										
LNMU0202ZER-MM	0.9	0.5	●	●	●								1.79	4	3.1

● : Line up

Grade
Insert
Ext. Toolholder
Int. Toolholder
Threading
Grooving
Miniature tool
Milling cutter
Endmill
Drilling tool
Tooling System
User's Guide
Index





STANDARD CUTTING CONDITIONS



ISO	Workpiece materials	Hardness	Priority	Grades	Cutting speed Vc (m/min)	Feed per tooth fz (mm/t)	
P	Carbon steels S45C, S55C, etc. C45, S55C, etc.	- 300HB	First choice	AH3225	100 - 300	0.2 - 1.2	
		- 300HB	For wear resistance	AH8015	100 - 300	0.2 - 1.2	
	Alloy steels SCM440, 42CrMo4, etc. 42CrMo4, 17Cr3, etc.	- 300HB	First choice	AH3225	100 - 300	0.2 - 1.2	
		- 300HB	For wear resistance	AH8015	100 - 300	0.2 - 1.2	
	Prehardened steels NAK80, PX5, etc.	30 - 40HRC	First choice	AH8015	100 - 200	0.2 - 0.8	
		30 - 40HRC	For impact resistance	AH3225	100 - 200	0.2 - 0.8	
M	Stainless steels SUS304, SUS316, etc. X5CrNi18-9, X5CrNiMo17-12-3, etc.	- 200HB	First choice	AH130	100 - 150	0.2 - 0.8	
K	Gray cast irons FC250, FC300, etc. 200, 300, etc.	150 - 250HB	First choice	AH8015	100 - 300	0.2 - 1.2	
		150 - 250HB	For impact resistance	AH3225	100 - 300	0.2 - 1.2	
	Ductile cast irons FCD600, etc. 600-3, etc.	150 - 250HB	First choice	AH8015	80 - 200	0.2 - 1.2	
		150 - 250HB	For impact resistance	AH3225	80 - 200	0.2 - 1.2	
S	Titanium alloy Ti-6Al-4V, etc.	- 40HRC	First choice	AH130	30 - 60	0.2 - 0.7	
		- 40HRC	For wear resistance	AH8015	30 - 60	0.2 - 0.7	
	Heat resistance alloy Inconel, Hastelloy, etc.	- 40HRC	First choice	AH8015	20 - 50	0.1 - 0.3	
		- 40HRC	For impact resistance	AH3225	20 - 50	0.1 - 0.3	
H	Hardened steel	SKD61, etc. X40CrMoV5-1, etc.	40 - 50HRC	First choice	AH8015	80 - 150	0.1 - 0.5
			40 - 50HRC	For impact resistance	AH3225	80 - 150	0.1 - 0.5
		SKD11, etc. X153CrMoV12, etc.	50 - 60HRC	First choice	AH8015	50 - 70	0.1 - 0.3

APPLICATION RANGE

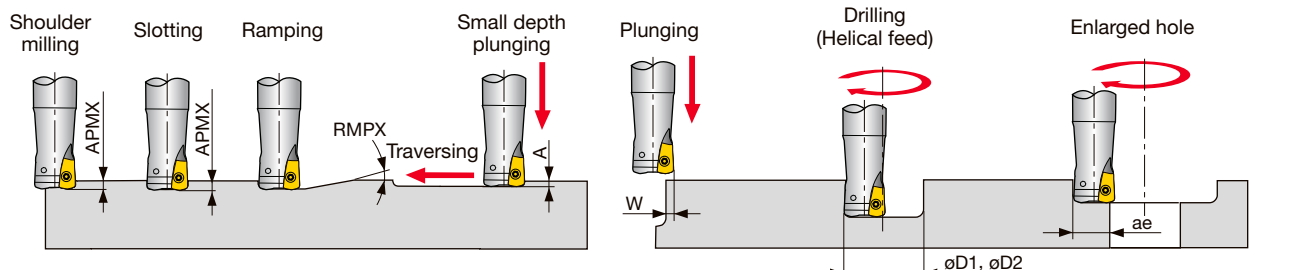
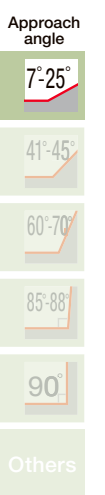

Designation	DCX	Max. depth of cut APMX	Max. ramping angle RMPX	Max. plunging depth A	Max. cutting width in plunging W	Min. machinable hole dia. øD1	Max. machinable hole dia. øD2	Max. cutting width in enlarged hole ae
E/HXN02R008...	8	0.5	0.5	0.03	2	11.5	13.2	5.87
E/HXN02R010...	10	0.5	2.8	0.15	2	13.8	17	7.82
E/HXN02R012...	12	0.5	1.9	0.15	2	17.8	21	9.81
E/HXN02R016...	16	0.5	1.2	0.15	2	25.8	29	13.8
E/HXN02R020...	20	0.5	0.88	0.15	2	33.8	37	17.8
E/HXN02M025...	25	0.5	0.66	0.15	2	43.8	47	22.8

Tool dia.: DCX (mm), Number of revolutions: n (min⁻¹), Feed speed: V_f (mm/min), Max. depth of cut: $a_p = 0.5$ mm, Number of teeth: CICT

$\phi 8$, CICT = 1		$\phi 10$, CICT = 2		$\phi 12$, CICT = 2		$\phi 16$			$\phi 20$			$\phi 25$		
n	V_f	n	V_f	n	V_f	n	V_f		n	V_f		n	V_f	
							CICT = 3	CICT = 4		CICT = 4	CICT = 5		CICT = 6	CICT = 7
7,960	6,370	6,370	10,200	5,310	8,500	3,980	9,560	12,740	3,180	10,180	12,720	2,550	12,240	14,280
$V_c = 200$ m/min, $f_z = 0.8$ mm/t														
7,960	6,370	6,370	10,200	5,310	8,500	3,980	9,560	12,740	3,180	10,180	12,720	2,550	12,240	14,280
$V_c = 200$ m/min, $f_z = 0.8$ mm/t														
5,970	2,990	4,780	4,780	3,980	3,980	2,990	4,490	5,980	2,390	4,780	5,980	1,910	5,730	6,690
$V_c = 150$ m/min, $f_z = 0.5$ mm/t														
4,780	2,390	3,820	3,820	3,190	3,190	2,390	3,590	4,780	1,910	3,820	4,780	1,530	4,590	5,360
$V_c = 120$ m/min, $f_z = 0.5$ mm/t														
7,960	6,370	6,370	10,200	5,310	8,500	3,980	9,560	12,740	3,180	10,180	12,720	2,550	12,240	14,280
$V_c = 200$ m/min, $f_z = 0.8$ mm/t														
5,970	4,780	4,780	7,650	3,980	6,370	2,990	7,180	9,570	2,390	7,650	9,560	1,530	7,350	8,570
$V_c = 150$ m/min, $f_z = 0.8$ mm/t														
1,590	800	1,270	1,270	1,060	1,060	800	1,200	1,600	640	1,280	1,600	510	1,530	1,790
$V_c = 40$ m/min, $f_z = 0.5$ mm/t														
1,190	240	1,000	400	800	320	600	360	480	480	390	480	380	460	540
$V_c = 30$ m/min, $f_z = 0.2$ mm/t														
4,780	1,440	3,820	2,300	3,190	1,920	2,390	2,160	2,870	1,910	2,300	2,870	1,530	2,760	3,220
$V_c = 120$ m/min, $f_z = 0.3$ mm/t														
2,390	480	1,910	770	1,590	640	1,190	720	960	950	760	950	760	920	1,070
$V_c = 60$ m/min, $f_z = 0.2$ mm/t														

TOOL GEOMETRY ON PROGRAMMING

When programming for CAM, the tool should be considered as a radius cutter. Usually, the corner radius should be set as $R = 1$ mm. If a larger radius is used, overcutting will occur. The following table shows the amount left uncut (t_1) and overcut (t_2).

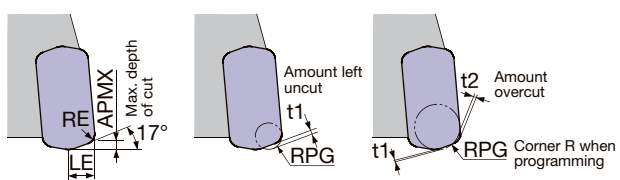

Max. depth of cut APMX (mm)	Corner radius RE (mm)	LE (mm)	Corner R when programming RPG	Amount left uncut t_1 (mm)	Amount overcut t_2 (mm)
0.5	0.9	2	0.5	0.38	0
0.5	0.9	2	0.8	0.31	0
0.5	0.9	2	1	0.26	0
0.5	0.9	2	1.5	0.14	0.08

*Recommended

High feed endmill, shank type

GAMP = +6°, GAMF = +5° ~ +11°

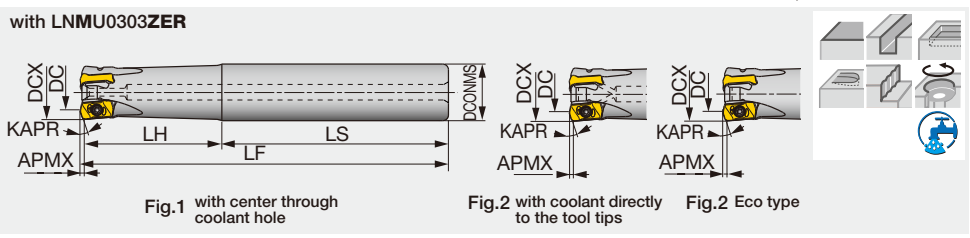

- High Feed Milling
- Face Milling
- Shoulder Milling
- Slot Milling
- Profile Milling
- Chamfering, Counterbore
- Finish Face Milling
- Approach angle
- 7°-25°
- 41°-45°
- 60°-70°
- 85°-88°
- 90°
- Others

Designation	APMX	APMX2	APMX3	DCX	CICT	DC	DC2	DC3	DCONMS	LF	LH	LS	KAPR	KAPR2*	KAPR3*	WT(kg)	Air hole	Insert	Fig.
EXN03R016M16.0-02 ⁽¹⁾	1	0.9	1	16	2	9.6	8.8	9.8	16	100	30	70	15°	10°	15°	0.2	With	LN*U03...	1
EXN03R016M16.0-02L ⁽¹⁾	1	0.9	1	16	2	9.6	8.8	9.8	16	150	50	100	15°	10°	15°	0.2	With	LN*U03...	1
EXN03R016M16.0-02-C ⁽¹⁾	1	0.9	1	16	2	9.6	8.8	9.8	16	100	30	70	15°	10°	15°	0.2	With	LN*U03...	2
EXN03R016M16.0-02L-C ⁽¹⁾	1	0.9	1	16	2	9.6	8.8	9.8	16	150	50	100	15°	10°	15°	0.2	With	LN*U03...	2
EXN03R016M16.0-02N ⁽¹⁾	1	0.9	1	16	2	9.6	8.8	9.8	16	100	30	70	15°	10°	15°	0.2	Without	LN*U03...	3
EXN03R018M16.0-02 ⁽¹⁾	1	0.9	1	18	2	11.5	10.7	11.7	16	100	30	70	17°	12°	17°	0.2	With	LN*U03...	1
EXN03R018M16.0-02L ⁽¹⁾	1	0.9	1	18	2	11.5	10.7	11.7	16	150	25	125	17°	12°	17°	0.2	With	LN*U03...	1
EXN03R020M20.0-03 ⁽²⁾	1	0.9	1	20	3	13.5	12.7	13.6	20	130	50	80	17°	12°	17°	0.3	With	LN*U03...	1
EXN03R020M20.0-03L ⁽²⁾	1	0.9	1	20	3	13.5	12.7	13.6	20	160	80	80	17°	12°	17°	0.3	With	LN*U03...	1
EXN03R020M20.0-03-C ⁽²⁾	1	0.9	1	20	3	13.5	12.7	13.6	20	130	50	80	17°	12°	17°	0.3	With	LN*U03...	2
EXN03R020M20.0-03L-C ⁽²⁾	1	0.9	1	20	3	13.5	12.7	13.6	20	160	80	80	17°	12°	17°	0.3	With	LN*U03...	2
EXN03R020M20.0-03N ⁽²⁾	1	0.9	1	20	3	13.5	12.7	13.6	20	130	50	80	17°	12°	17°	0.3	Without	LN*U03...	3
EXN03R020M20.0-04 ⁽¹⁾	1	0.9	1	20	4	13.5	12.7	13.6	20	130	50	80	17°	12°	17°	0.3	With	LN*U03...	1
EXN03R020M20.0-04-C ⁽¹⁾	1	0.9	1	20	4	13.5	12.7	13.6	20	130	50	80	17°	12°	17°	0.3	With	LN*U03...	2
EXN03R022M20.0-03 ⁽²⁾	1	0.9	1	22	3	15.5	14.7	15.6	20	130	50	80	17°	12°	17°	0.3	With	LN*U03...	1
EXN03R022M20.0-03L ⁽²⁾	1	0.9	1	22	3	15.5	14.7	15.6	20	160	30	130	17°	12°	17°	0.4	With	LN*U03...	1
EXN03R022M20.0-04 ⁽¹⁾	1	0.9	1	22	4	15.5	14.7	15.6	20	130	50	80	17°	12°	17°	0.3	With	LN*U03...	1
EXN03R025M25.0-04 ⁽²⁾	1	0.9	1	25	4	18.5	17.7	18.6	25	140	60	80	17°	12°	17°	0.5	With	LN*U03...	1
EXN03R025M25.0-04L ⁽²⁾	1	0.9	1	25	4	18.5	17.7	18.6	25	180	100	80	17°	12°	17°	0.6	With	LN*U03...	1
EXN03R025M25.0-04-C ⁽²⁾	1	0.9	1	25	4	18.5	17.7	18.6	25	140	60	80	17°	12°	17°	0.5	With	LN*U03...	2
EXN03R025M25.0-04L-C ⁽²⁾	1	0.9	1	25	4	18.5	17.7	18.6	25	180	100	80	17°	12°	17°	0.6	With	LN*U03...	2
EXN03R025M25.0-04N ⁽²⁾	1	0.9	1	25	4	18.5	17.7	18.6	25	140	60	80	17°	12°	17°	0.5	Without	LN*U03...	3
EXN03R025M25.0-05 ⁽¹⁾	1	0.9	1	25	5	18.5	17.7	18.6	25	140	60	80	17°	12°	17°	0.5	With	LN*U03...	1
EXN03R025M25.0-05-C ⁽¹⁾	1	0.9	1	25	5	18.5	17.7	18.6	25	140	60	80	17°	12°	17°	0.5	With	LN*U03...	2
EXN03R028M25.0-04 ⁽²⁾	1	0.9	1	28	4	21.5	20.7	21.6	25	140	60	80	17°	12°	17°	0.5	With	LN*U03...	1
EXN03R028M25.0-04L ⁽²⁾	1	0.9	1	28	4	21.5	20.7	21.6	25	180	35	145	17°	12°	17°	0.7	With	LN*U03...	1
EXN03R028M25.0-05 ⁽¹⁾	1	0.9	1	28	5	21.5	20.7	21.6	25	140	60	80	17°	12°	17°	0.5	With	LN*U03...	1
EXN03R030M32.0-04 ⁽²⁾	1	0.9	1	30	4	23.5	22.7	23.6	32	150	70	80	17°	12°	17°	0.8	With	LN*U03...	1
EXN03R030M32.0-04L ⁽²⁾	1	0.9	1	30	4	23.5	22.7	23.6	32	200	120	80	17°	12°	17°	0.9	With	LN*U03...	1
EXN03R030M32.0-05 ⁽²⁾	1	0.9	1	30	5	23.5	22.7	23.6	32	150	70	80	17°	12°	17°	0.8	With	LN*U03...	1
EXN03R032M32.0-05 ⁽²⁾	1	0.9	1	32	5	25.5	24.7	25.6	32	150	70	80	17°	12°	17°	0.8	With	LN*U03...	1
EXN03R032M32.0-05L ⁽²⁾	1	0.9	1	32	5	25.5	24.7	25.6	32	200	120	80	17°	12°	17°	1.1	With	LN*U03...	1
EXN03R032M32.0-05-C ⁽²⁾	1	0.9	1	32	5	25.5	24.7	25.6	32	150	70	80	17°	12°	17°	0.8	With	LN*U03...	2
EXN03R032M32.0-05L-C ⁽²⁾	1	0.9	1	32	5	25.5	24.7	25.6	32	200	120	80	17°	12°	17°	1.1	With	LN*U03...	2
EXN03R032M32.0-05N ⁽²⁾	1	0.9	1	32	5	25.5	24.7	25.6	32	150	70	80	17°	12°	17°	0.8	Without	LN*U03...	3
EXN03R032M32.0-06 ⁽¹⁾	1	0.9	1	32	6	25.5	24.7	25.6	32	150	70	80	17°	12°	17°	0.9	With	LN*U03...	1
EXN03R032M32.0-06-C ⁽¹⁾	1	0.9	1	32	6	25.5	24.7	25.6	32	150	70	80	17°	12°	17°	0.8	With	LN*U03...	2
EXN03R035M32.0-05 ⁽²⁾	1	0.9	1	35	5	28.5	27.7	28.6	32	150	35	115	17°	12°	17°	0.9	With	LN*U03...	1
EXN03R035M32.0-05L ⁽²⁾	1	0.9	1	35	5	28.5	27.7	28.6	32	200	35	165	17°	12°	17°	1.2	With	LN*U03...	1
EXN03R035M32.0-06 ⁽²⁾	1	0.9	1	35	6	28.5	27.7	28.6	32	150	35	115	17°	12°	17°	0.9	With	LN*U03...	1
EXN03R040M32.0-06-C ⁽²⁾	1	0.9	1	40	6	33.6	32.8	33.7	32	150	45	105	17°	12°	17°	1	With	LN*U03...	2
EXN03R040M32.0-06L-C ⁽²⁾	1	0.9	1	40	6	33.6	32.8	33.7	32	220	45	175	17°	12°	17°	1.4	With	LN*U03...	2

*APMX2, KAPR2 : with LNMU0303UER
 *APMX3, KAPR3 : with LNMU0303ZER
 Clamping screws used for (1) and (2) above are different. See below for the part codes.

SPARE PARTS

Designation	Clamping screw	Lubricant	Wrench	Tool diameter tolerance	
EXN03...	(1) CSPB-2.5 (2) CSPB-2.5L080	M-1000	IP-8D	Tool diameter	0 / -0.45

Recommended clamping torque: 1.3 N·m

Reference pages: Inserts → **H028 - H029**, Standard cutting conditions → **H030 - H033**

High feed mill shank type cutter, with screw clamp system

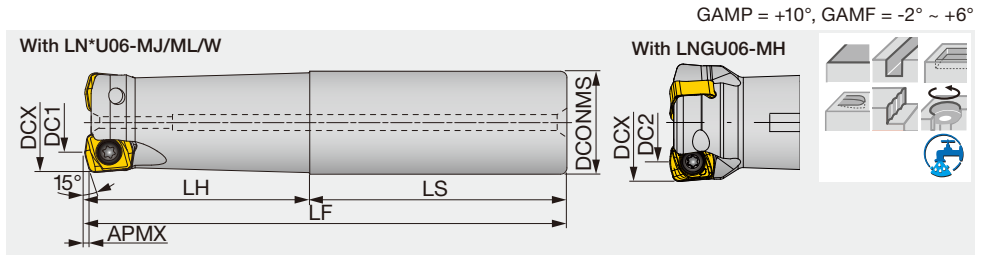

Designation	APMX	DCX	CICT	DC1	DC2	DCONMS	LF	LH	LS	WT (kg)	Air hole	Insert
EXN06R032M32.0-02	1.5	32	2	19.7	19.1	32	150	70	80	0.8	with	LN*U06...
EXN06R032M32.0-02L	1.5	32	2	19.7	19.1	32	200	120	80	1.1	with	LN*U06...
EXN06R035M32.0-02	1.5	35	2	22.7	22	32	150	45	105	0.9	with	LN*U06...
EXN06R035M32.0-02L	1.5	35	2	22.7	22	32	200	45	155	1.2	with	LN*U06...
EXN06R040M32.0-03	1.5	40	3	27.7	27	32	150	45	105	0.9	with	LN*U06...
EXN06R040M32.0-03L	1.5	40	3	27.7	27	32	220	45	175	1.3	with	LN*U06...

Tool diameter tolerance	
Tool diameter	0 / -0.55

HXN03

High feed endmill, modular type (TungFlex)

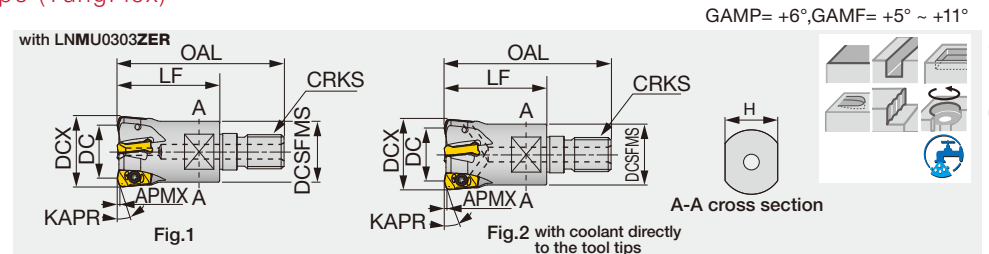

Designation	APMX	APMX2	APMX3	DCX	CICT	DC	DC2	DC3	OAL	LF	H	DCSFMS	KAPR	KAPR2*	KAPR3*	CRKS	WT(kg)	Air hole	Insert	Fig.
HXN03R016MM08-02 ⁽¹⁾	1	0.9	1	16	2	9.6	8.8	9.8	42	25	10	12.8	15°	10°	15°	M8	0.03	With	LN*U03...	1
HXN03R016MM08-02-C ⁽¹⁾	1	0.9	1	16	2	9.6	8.8	9.8	42	25	10	12.8	15°	10°	15°	M8	0.03	With	LN*U03...	2
HXN03R018MM08-02 ⁽¹⁾	1	0.9	1	18	2	11.5	10.7	11.7	42	25	10	14.5	17°	12°	17°	M8	0.04	With	LN*U03...	1
HXN03R020MM10-03 ⁽²⁾	1	0.9	1	20	3	13.5	12.7	13.6	49	30	15	17.8	17°	12°	17°	M10	0.06	With	LN*U03...	1
HXN03R020MM10-03-C ⁽²⁾	1	0.9	1	20	3	13.5	12.7	13.6	49	30	15	17.8	17°	12°	17°	M10	0.06	With	LN*U03...	2
HXN03R020MM10-04 ⁽¹⁾	1	0.9	1	20	4	13.5	12.7	13.6	49	30	15	17.8	17°	12°	17°	M10	0.06	With	LN*U03...	1
HXN03R020MM10-04-C ⁽¹⁾	1	0.9	1	20	4	13.5	12.7	13.6	49	30	15	17.8	17°	12°	17°	M10	0.06	With	LN*U03...	2
HXN03R022MM10-03 ⁽²⁾	1	0.9	1	22	3	15.5	14.7	15.6	49	30	15	17.8	17°	12°	17°	M10	0.06	With	LN*U03...	1
HXN03R022MM10-04 ⁽¹⁾	1	0.9	1	22	4	15.5	14.7	15.6	49	30	15	17.8	17°	12°	17°	M10	0.07	With	LN*U03...	1
HXN03R025MM12-04 ⁽²⁾	1	0.9	1	25	4	18.5	17.7	18.6	57	35	17	20.8	17°	12°	17°	M12	0.1	With	LN*U03...	1
HXN03R025MM12-04-C ⁽²⁾	1	0.9	1	25	4	18.5	17.7	18.6	57	35	17	20.8	17°	12°	17°	M12	0.1	With	LN*U03...	2
HXN03R025MM12-05 ⁽¹⁾	1	0.9	1	25	5	18.5	17.7	18.6	57	35	17	20.8	17°	12°	17°	M12	0.11	With	LN*U03...	1
HXN03R025MM12-05-C ⁽¹⁾	1	0.9	1	25	5	18.5	17.7	18.6	57	35	17	20.8	17°	12°	17°	M12	0.1	With	LN*U03...	2
HXN03R028MM12-04 ⁽²⁾	1	0.9	1	28	4	21.5	20.7	21.6	57	35	17	23	17°	12°	17°	M12	0.12	With	LN*U03...	1
HXN03R028MM12-05 ⁽²⁾	1	0.9	1	28	5	21.5	20.7	21.6	57	35	17	23	17°	12°	17°	M12	0.12	With	LN*U03...	1
HXN03R030MM16-04 ⁽²⁾	1	0.9	1	30	4	23.5	22.7	23.6	63	40	22	28.8	17°	12°	17°	M16	0.19	With	LN*U03...	1
HXN03R030MM16-05 ⁽²⁾	1	0.9	1	30	5	23.5	22.7	23.6	63	40	22	28.8	17°	12°	17°	M16	0.2	With	LN*U03...	1
HXN03R032MM16-05 ⁽²⁾	1	0.9	1	32	5	25.5	24.7	25.6	63	40	22	28.8	17°	12°	17°	M16	0.2	With	LN*U03...	1
HXN03R032MM16-05-C ⁽²⁾	1	0.9	1	32	5	25.5	24.7	25.6	63	40	22	28.8	17°	12°	17°	M16	0.2	With	LN*U03...	2
HXN03R032MM16-06 ⁽¹⁾	1	0.9	1	32	6	25.5	24.7	25.6	63	40	22	28.8	17°	12°	17°	M16	0.21	With	LN*U03...	1
HXN03R032MM16-06-C ⁽¹⁾	1	0.9	1	32	6	25.5	24.7	25.6	63	40	22	28.8	17°	12°	17°	M16	0.2	With	LN*U03...	2
HXN03R040MM16-06-C ⁽²⁾	1	0.9	1	40	6	33.6	32.8	33.7	63	40	22	28.8	17°	12°	17°	M16	0.27	With	LN*U03...	2

*APMX2, KAPR2 : with LNMU0303UER
*APMX3, KAPR3 : with LNMU0303ZER
Clamping screws used for (1) and (2) above are different. See below for the part codes.

SPARE PARTS

Designation	Clamping screw	Lubricant	Wrench
EXN06	CSPB-5	M-1000	IP-20D
HXN03...	(1) CSPB-2.5 (2) CSPB-2.5L080	M-1000	IP-8D

Tool diameter tolerance	
Tool diameter	0 / -0.45

Recommended clamping torque: CSPB-5 = 5 N·m, CSPB-2.5, CSPB-2.5L080 = 1.3 N·m

Reference pages: Inserts → **H028 - H029**, Standard cutting conditions → **H030 - H033**, TungFlex → **H036 - H037**

High feed mill bore type cutter, for 4-corner double sided inserts

GAMP = +6°, GAMF = +12° ~ 13°

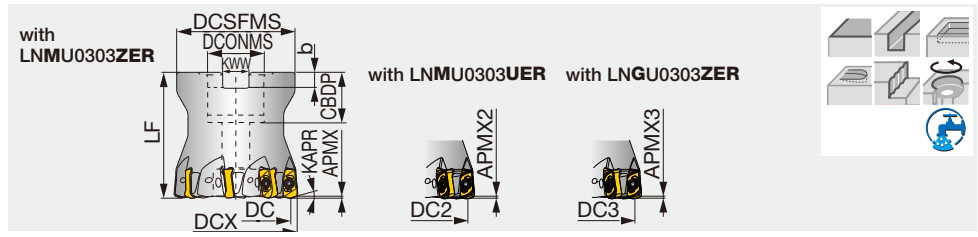

Designation	APMX	APMX2	APMX3	DCX	CICT	DC	DC2	DC3	DCSFMS	DCONMS	CBDP	LF	b	KWW	KAPR	KAPR2	KAPR3	WT(kg)	Air hole	Insert
TXN03R040M16.0E05	1	0.9	1	40	5	33.6	32.8	33.7	35	16	18	40	5.6	8.4	17°	12°	17°	0.2	With LN*U03...	
TXN03R040M16.0E06	1	0.9	1	40	6	33.6	32.8	33.7	35	16	18	40	5.6	8.4	17°	12°	17°	0.2	With LN*U03...	
TXN03R050M22.0E05	1	0.9	1	50	5	43.6	42.8	43.7	47	22	20	50	6.3	10.4	17°	12°	17°	0.5	With LN*U03...	
TXN03R050M22.0E08	1	0.9	1	50	8	43.6	42.8	43.7	47	22	20	50	6.3	10.4	17°	12°	17°	0.5	With LN*U03...	
TXN03R050M22.2-08	1	0.9	1	50	8	43.6	42.8	43.7	47	22.225	20	50	5	8	17°	12°	17°	0.5	With LN*U03...	

*KAPR : with LNMU0303ZER
*KAPR2 : with LNMU0303UER
*KAPR3 : with LNGU0303ZER

Tool diameter tolerance	
Tool diameter	0 / -0.45

SPARE PARTS

Designation	Clamping screw	Lubricant	Shell locking bolt	Wrench
TXN03R04...	CSPB-2.5L080	M-1000	CM8X30H	IP-8D
TXN03R05...	CSPB-2.5L080	M-1000	CM10X30H	IP-8D

Recommended clamping torque: 1.3 N·m

Approach angle

- 7°-25°
- 41°-45°
- 60°-70°
- 85°-88°
- 90°
- Others

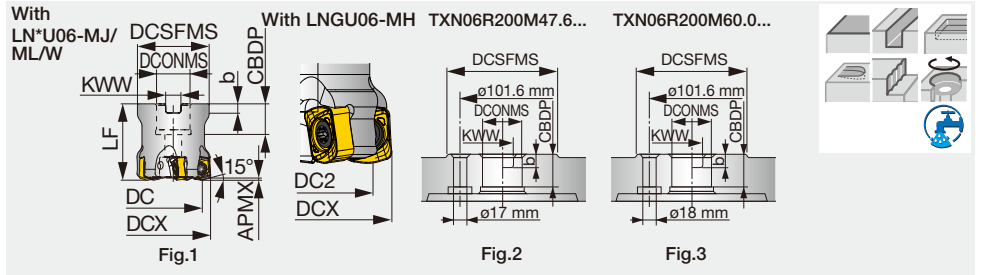

GAMP = +10°, GAMF = +2° ~ +6°

Designation	APMX	DCX	CICT	DC1	DC2	DCSFMS	LF	DCONMS	CBDP	KWW	b	WT (kg)	Air hole	Insert	Fig.
TXN06R050M22.0E04 ⁽¹⁾	1.5	50	4	37.6	36.9	47	50	22	20	10.4	6.3	0.4	with	LN*U06...	1
TXN06R050M22.0E05 ⁽¹⁾	1.5	50	5	37.6	36.9	47	50	22	20	10.4	6.3	0.4	with	LN*U06...	1
TXN06R050M22.2-04 ⁽²⁾	1.5	50	4	37.6	36.9	47	50	22.225	20	8	5	0.4	with	LN*U06...	1
TXN06R050M22.2-05 ⁽¹⁾	1.5	50	5	37.6	36.9	47	50	22.225	20	8	5	0.4	with	LN*U06...	1
TXN06R052M22.0E04 ⁽¹⁾	1.5	52	4	39.6	38.9	49	50	22	20	10.4	6.3	0.5	with	LN*U06...	1
TXN06R052M22.0E05 ⁽¹⁾	1.5	52	5	39.6	38.9	49	50	22	20	10.4	6.3	0.5	with	LN*U06...	1
TXN06R063M22.0E04 ⁽²⁾	1.5	63	4	50.6	49.8	59	50	22	20	10.4	6.3	0.8	with	LN*U06...	1
TXN06R063M22.0E06 ⁽²⁾	1.5	63	6	50.6	49.8	59	50	22	20	10.4	6.3	0.8	with	LN*U06...	1
TXN06R063M22.2-04 ⁽²⁾	1.5	63	4	50.6	49.8	59	50	22.225	20	8	5	0.8	with	LN*U06...	1
TXN06R063M22.2-06 ⁽²⁾	1.5	63	6	50.6	49.8	59	50	22.225	20	8	5	0.8	with	LN*U06...	1
TXN06R066M27.0E04	1.5	66	4	53.6	52.8	63	50	27	22	12.4	7	0.8	with	LN*U06...	1
TXN06R066M27.0E06	1.5	66	6	53.6	52.8	63	50	27	22	12.4	7	0.8	with	LN*U06...	1
TXN06R080M27.0E05	1.5	80	5	67.6	66.8	76	63	27	22	12.4	7	1.6	with	LN*U06...	1
TXN06R080M27.0E05	1.5	80	5	67.6	66.8	60	63	27	22	12.4	7	1.2	with	LN*U06...	1
TXN06R080M27.0E08	1.5	80	8	67.6	66.8	76	63	27	22	12.4	7	1.6	with	LN*U06...	1
TXN06R080M27.0EE08	1.5	80	8	67.6	66.8	60	63	27	22	12.4	7	1.2	with	LN*U06...	1
TXN06R080M31.7-05	1.5	80	5	67.6	66.8	76	63	31.75	32	12.7	8	1.6	with	LN*U06...	1
TXN06R080M31.7-08	1.5	80	8	67.6	66.8	76	63	31.75	32	12.7	8	1.6	with	LN*U06...	1
TXN06R100M31.7-06	1.5	100	6	87.6	86.8	96	63	31.75	32	12.7	8	2.2	with	LN*U06...	1
TXN06R100M32.0E06	1.5	100	6	87.6	86.8	96	63	32	25	14.4	8	2.2	with	LN*U06...	1
TXN06R125M38.1-08	1.5	125	8	112.6	111.8	100	63	38.1	43	15.9	10	3	with	LN*U06...	1
TXN06R125M40.0E08	1.5	125	8	112.6	111.8	100	63	40	37	16.4	9	3	with	LN*U06...	1
TXN06R160M40.0E10	1.5	160	10	147.6	146.8	100	63	40	37	16.4	9	5	with	LN*U06...	1
TXN06R160M50.8-10	1.5	160	10	147.6	146.8	100	63	50.8	46	19	11	4.6	with	LN*U06...	1
TXN06R200M47.6-12	1.5	200	12	187.6	186.8	130	63	47.625	38	25.4	14	7.7	without	LN*U06...	2
TXN06R200M60.0E12	1.5	200	12	187.6	186.8	130	63	60	38	25.7	14	7.2	without	LN*U06...	3

Shell locking bolt used for (1) and (2) above are different. See below for the part codes.

Tool diameter tolerance	
Tool diameter	0 / -0.55

SPARE PARTS

Designation	Clamping screw	Lubricant	Shell locking bolt 1	Shell locking bolt 2	Grip	Torx bit
TXN06R050, 052, 063M...	CSPB-5	M-1000	-	(1) FSHM10-40H (2) CM10-30H	H-TB2W	BLDIP20/S7
TXN06R066,080M27.0...	CSPB-5	M-1000	-	CM12X30H	H-TB2W	BLDIP20/S7
TXN06R080,100M31.7...	CSPB-5	M-1000	-	CM16X40H	H-TB2W	BLDIP20/S7
TXN06R125M...	CSPB-5	M-1000	TMBA-M20H	-	H-TB2W	BLDIP20/S7
TXN06R160M40.0...	CSPB-5	M-1000	TMBA-M20H	-	H-TB2W	BLDIP20/M7
TXN06R160M50.8...	CSPB-5	M-1000	TMBA-M24H	-	H-TB2W	BLDIP20/M7
TXN06R200M...	CSPB-5	M-1000	-	-	H-TB2W	BLDIP20/M7

Recommended clamping torque: 5 N·m





High Feed
Milling

INSERT

LNMU03ZER-MJ (for general purpose)

Face Milling

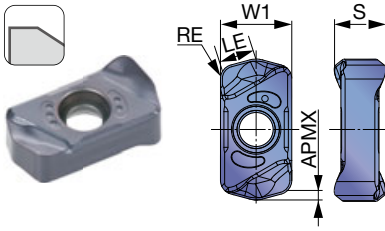

Shoulder Milling

LNMU03ZER-ML (for low cutting force)

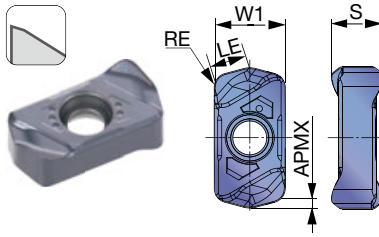

LNMU03ZER-MS (for stainless steel)

Slot Milling

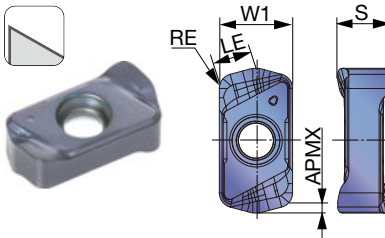

Profile Milling

LNGU03ZER-MH (Robust cutting edges)

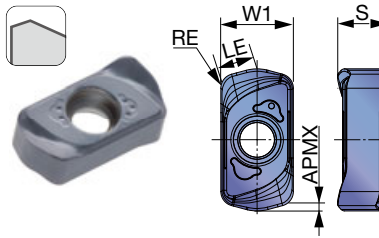

Chamfering,
Counterbore

LNMU03UER-MJ (for general purpose, low approach angle)

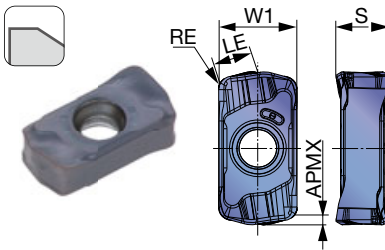

Finish
Face Milling

LNMU03UER-ML (for low cutting force, low approach angle)

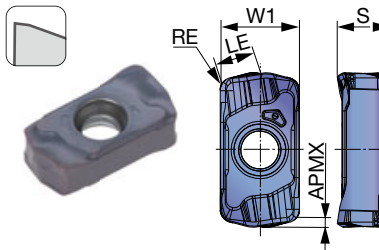

Approach
angle

7°-25°

LNMU06-MJ (for general purpose)

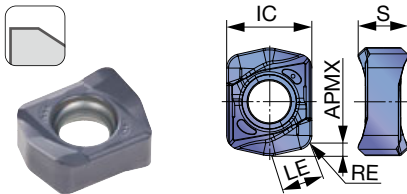

41°-45°

LNMU06-ML (for low cutting force)

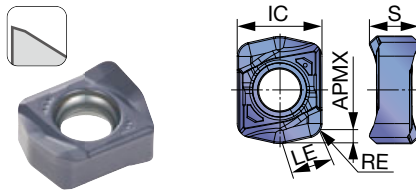

60°-70°

LNGU06-MH (Robust cutting edges)

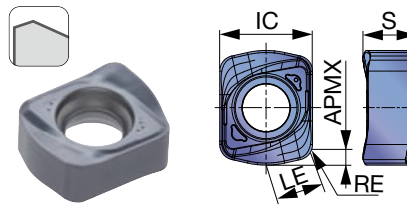

85-88°

LNGU06-W (Wiper, 2 cutting edge)

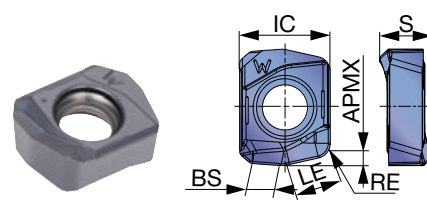

90°

Others

Reference pages: Standard cutting conditions → **H030 - H035**

P	Steel		★							
M	Stainless	★	☆							
K	Cast iron		☆	☆	★					
N	Non-ferrous									
S	Superalloys	★	☆	☆		★				
H	Hard materials			☆		★	☆			

★ : First choice
☆ : Second choice

Designation	RE	APMX	Coated						LE	W1	IC	S	BS
			AH130	AH3225	AH725	AH120	AH8015	AH8005					
LNMU0303ZER-MJ	1.2	1	●	●	●	●	●		3.2	6	-	4.3	-
LNMU0303ZER-ML	1.2	1	●	●	●		●		3.2	6	-	4.3	-
LNMU0303ZER-MS	1.2	1	●	●					3.2	6	-	4.3	-
LNGU0303ZER-MH	1.2	1					●	●	3.2	6	-	4.3	-
LNMU0303UER-MJ	1	0.9	●	●			●		3.1	6	-	4.1	-
LNMU0303UER-ML	1	0.9	●	●			●		3.1	6	-	4.1	-
LNMU06X5ZER-MJ	2	1.5	●	●	●	●	●		6	-	12	7	-
LNMU06X5ZER-ML	2	1.5	●	●	●	●	●		6	-	12	7	-
LNGU06X5ZER-MH	2	1.5					●	●	6	-	12	7	-
LNGU06X5ZER-W	2	1.5		●					6	-	12	7	3.6

- When wiper insert (-W) is used, the value of feed per rev. (mm/rev) must be less than 3.6 mm x n. for keeping this value, the number of wiper insert (n) and feed per tooth (mm/tooth) should be adjusted
- Wiper insert (-W) can be used just for face milling. It's not suitable for ramping or pocket milling

● : Line up

Grade
Insert
Toolholder
Ext. Toolholder
Int. Toolholder
Threading
Grooving
Miniature tool
Milling cutter
Endmill
Drilling tool
Tooling System
User's Guide
Index





STANDARD CUTTING CONDITIONS

EXN03, HXN03, TXN03

ZER type



ISO	Workpiece materials	Hardness	Priority	Grade	Chip-breaker	Cutting speed Vc (m/min)	Feed per tooth: fz (mm/t)										
							Tool dia.: DCX (mm)			Plunging		ø16, CICT = 2		ø18, CICT = 2		ø20	
							ø16 - ø22	ø25 - ø50		n	Vf	n	Vf	n	Vf	CICT = 3	CICT = 4
P	Carbon steels S45C, S55C, etc. C45, C55, etc.	- 300HB	First choice	AH3225	MJ	100 - 300	0.5 - 1.2	0.5 - 1.5	0.1	3,980	6,370	3,540	5,660	3,180	7,630	10,180	
	Alloy steels SCM440, etc. SCr415, etc.	- 300HB	First choice	AH3225	MJ	100 - 300	0.5 - 1.2	0.5 - 1.5	0.1	3,980	6,370	3,540	5,660	3,180	7,630	10,180	
	Prehardened steels NAK80, PX5, etc.	30-40HRC	First choice	AH3225	MJ	100 - 200	0.5 - 1.0	0.5 - 1.0	0.1	2,980	4,170	2,650	3,710	2,390	5,020	6,690	
M	Stainless steels SUS304, X5CrNi18-9, etc.	- 200HB	First choice	AH130	MS	80 - 150	0.3 - 0.8	0.3 - 0.8	0.1	2,390	2,390	2,120	2,120	1,910	2,860	3,820	
	Precipitation hardening stainless steels SUS630, etc.	28HRC - (H1150)	First choice for wear resistance	AH130	MS	80 - 150	0.2 - 0.5	0.2 - 0.5	0.1	2,390	1,430	2,120	1,270	1,910	1,720	2,290	
	X5CrNiCuNb16-4, etc.	40HRC - (H900)	First choice for impact resistance	AH3225	ML	80 - 120	0.1 - 0.3	0.1 - 0.3	0.1	1,990	800	1,770	710	1,590	950	1,270	
K	Gray cast irons FC250, etc. 250, etc.	150-250HB	First choice	AH725	MJ	100 - 300	0.5 - 1.2	0.5 - 1.5	0.1	3,980	6,370	3,540	5,660	3,180	7,630	10,180	
	Ductile cast irons FCD400, etc. 400-15S, etc.	150-250HB	First choice	AH725	MJ	80 - 200	0.5 - 1.2	0.5 - 1.5	0.1	2,980	4,770	2,650	4,240	2,390	5,740	7,650	
	Titanium alloy Ti-6Al-4V, etc.	- 40HRC	First choice for impact resistance	AH130	ML	30 - 60	0.3 - 0.7	0.3 - 0.7	0.08	800	640	710	570	640	770	1,020	
S	Heat-resistant alloy Inconel, Hastelloy, etc.	- 40HRC	First choice for impact resistance	AH8015	ML	20 - 50	0.1 - 0.3	0.1 - 0.3	0.05	600	240	530	210	480	290	380	
	Hot mold steel SKD61, etc. X40CrMoV5-1, etc.	40-55HRC	First choice	AH8015	MH	80 - 150	0.1 - 0.5	0.1 - 0.5	0.05	2,390	1,430	2,120	1,270	1,910	1,720	2,290	
	Hot mold steel of D.T.C materials DAC**, DH**, DIEVER, etc.	40-55HRC	First choice for impact resistance	AH8015	MJ	50-100	0.1 - 0.3	0.1 - 0.3	0.05	1,590	640	1,420	570	1,270	760	1,020	
H	Cold mold steels SKD11, etc.	55-60HRC	First choice	AH8005	MH	50 - 70	0.05 - 0.2	0.03 - 0.1	0.03	1,190	290	1,060	250	950	340	450	
	X153CrMoV12, etc.	55-60HRC	for impact resistance	AH8015	MH	50 - 70	0.05 - 0.1	0.05 - 0.2	0.03	1,190	150	1,060	130	950	170	230	

- When chips stay in the cutting zone during slotting or pocketing, use air blast to remove chips from the work area

- Tool overhang length must be as short as possible to avoid chatter. When the tool overhang length is long, decrease the number of revolutions and feed

Approach angle

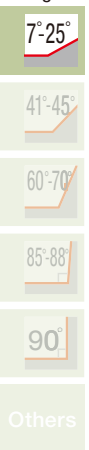

Others

APPLICATION RANGE

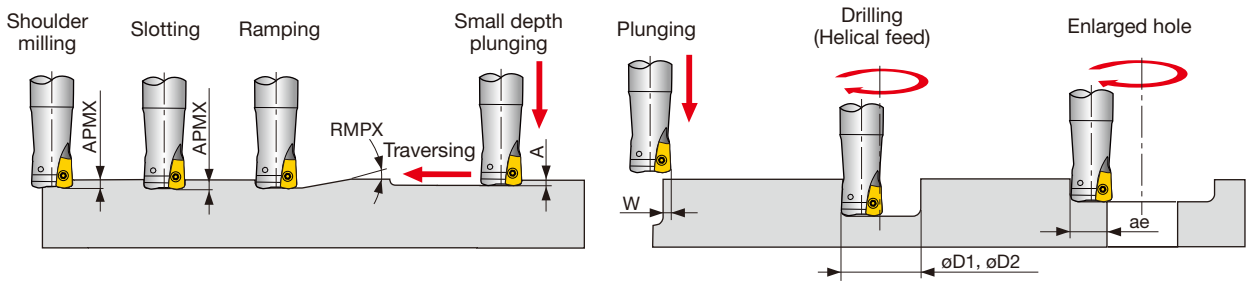

Designation	DCX	Max. depth of cut			A	Max. cutting width in plunging		Min. machinable hole dia.		Max. machinable hole dia. øD2	Max. cutting width in enlarged hole ae
		APMX	RMPX			W	øD1				
			MJ/ML/MS	MH				MJ/ML/MS	MH		
E/HXN03R016M...	16	1	2.1	1.7	0.3	3.5	3	22	23	30	12.5
E/HXN03R018M...	18	1	1.7	1.6	0.3	3.5	3	26	27	34	14.5
E/HXN03R020M...	20	1	1.4	1.3	0.3	3.5	3	30	31	38	16.5
E/HXN03R022M...	22	1	1.2	1.1	0.3	3.5	3	34	35	42	18.5
E/HXN03R025M...	25	1	1.0	0.9	0.3	3.5	3	40	41	48	21.5
E/HXN03R028M...	28	1	0.8	0.8	0.3	3.5	3	46	46	54	24.5
E/HXN03R030M...	30	1	0.7	0.7	0.3	3.5	3	50	50	58	26.5
E/HXN03R032M...	32	1	0.7	0.7	0.3	3.5	3	54	54	62	28.5
EXN03R035M...	35	1	0.6	0.6	0.3	3.5	3	60	60	68	31.5
E/H/TXN03R040M...	40	1	0.5	0.5	0.3	3.5	3	70	70	78	36.5
TXN03R050M...	50	1	0.4	0.4	0.3	3.5	3	90	90	98	46.5

For DCX above ø33 mm, slot milling, ramping or contouring is not recommended as chips may be re-cut



Tool dia.: DCX (mm), Number of revolutions: n (min⁻¹), Feed speed: V_f (mm/min), Max. depth of cut: $a_p = 1$ mm, Number of teeth: CICT

ø22			ø25			ø28			ø30			ø32			ø35			ø40			ø50		
n	V_f		n	V_f		n	V_f		n	V_f		n	V_f		n	V_f		n	V_f		n	V_f	
	CICT=3	CICT=4		CICT=4	CICT=5		CICT=4	CICT=5		CICT=4	CICT=5		CICT=5	CICT=6		CICT=5	CICT=6		CICT=5	CICT=6		CICT=5	CICT=6
2,890	6,940	9,250	2,550	8,160	10,180	2,270	7,280	9,100	2,120	8,480	10,600	1,990	9,950	11,940	1,820	9,100	10,920	1,590	7,950	9,540	1,270	6,350	10,160
$V_c = 200$ m/min, $f_z = 1.0$ mm/t																							
2,890	6,940	9,250	2,550	8,160	10,180	2,270	7,280	9,100	2,120	8,480	10,600	1,990	9,950	11,940	1,820	9,100	10,920	1,590	7,950	9,540	1,270	6,350	10,160
$V_c = 200$ m/min, $f_z = 1.0$ mm/t																							
2,170	4,560	6,080	1,910	5,350	6,690	1,710	4,790	5,990	1,590	4,450	5,570	1,490	5,220	6,260	1,360	4,760	5,710	1,190	4,170	5,000	950	3,330	5,320
$V_c = 150$ m/min, $f_z = 0.7$ mm/t																							
2,170	4,560	6,080	1,910	5,350	6,690	1,710	4,790	5,990	1,590	4,450	5,570	1,490	5,220	6,260	1,360	4,760	5,710	1,190	4,170	5,000	950	3,330	5,320
$V_c = 150$ m/min, $f_z = 0.7$ mm/t																							
3,180	4,770	6,360	1,530	3,060	3,820	1,360	2,720	3,400	1,270	2,540	3,180	1,190	2,980	3,570	1,090	2,720	3,270	960	2,400	2,880	760	1,900	2,280
$V_c = 120$ m/min, $f_z = 0.5$ mm/t																							
1,740	1,570	2,090	1,530	1,840	2,300	1,370	1,640	2,060	1,270	1,520	1,910	1,190	1,790	2,140	1,090	1,640	1,960	960	1,440	1,730	760	1,140	1,820
$V_c = 120$ m/min, $f_z = 0.3$ mm/t																							
1,450	870	1,160	1,270	1,020	1,270	1,140	910	1,140	1,060	850	1,060	1,000	1,000	1,200	910	910	1,090	800	800	960	640	640	1,020
$V_c = 100$ m/min, $f_z = 0.2$ mm/t																							
2,890	6,940	9,250	2,550	8,160	10,180	2,270	7,280	9,100	2,120	8,480	10,600	1,990	9,950	11,940	1,820	9,100	10,920	1,590	7,950	9,540	1,270	6,350	10,160
$V_c = 200$ m/min, $f_z = 1.0$ mm/t																							
2,170	5,210	6,940	1,910	6,110	7,640	1,710	5,460	6,820	1,590	6,360	7,950	1,490	7,450	8,940	1,360	6,800	8,160	1,190	5,950	7,140	950	4,750	5,700
$V_c = 150$ m/min, $f_z = 1.0$ mm/t																							
580	700	930	510	820	1,020	450	730	910	420	840	1,050	400	1,000	1,200	360	900	1,080	320	800	960	250	630	1,000
$V_c = 40$ m/min, $f_z = 0.5$ mm/t																							
430	260	340	380	230	290	340	200	260	320	260	320	300	300	360	270	270	320	240	240	290	190	190	300
$V_c = 30$ m/min, $f_z = 0.2$ mm/t																							
1,740	1,570	2,090	1,530	1,840	2,300	1,360	1,630	2,040	1,270	1,520	1,910	1,190	1,790	2,140	1,090	1,640	1,960	950	1,430	1,710	760	1,140	1,820
$V_c = 120$ m/min, $f_z = 0.3$ mm/t																							
1,160	700	930	1,020	820	1,020	910	730	910	850	680	850	800	800	960	730	730	880	640	640	770	510	510	820
$V_c = 80$ m/min, $f_z = 0.2$ mm/t																							
870	310	420	760	300	380	680	270	340	640	260	320	600	300	360	550	230	340	480	240	280	380	200	300
$V_c = 60$ m/min, $f_z = 0.1$ mm/t																							
870	160	210	760	150	190	680	140	170	640	130	160	600	150	180	550	120	170	480	120	140	380	100	150
$V_c = 60$ m/min, $f_z = 0.06$ mm/t																							

- The above table shows the conditions for standard shank type cutters. When using long shank type cutters, the number of teeth may be different.
 - Cutting conditions are generally limited by the rigidity and power of the machine and the rigidity

of the workpiece. When setting the conditions, start from half of the values of the standard cutting conditions and then increase the value gradually while making sure the machine is running normally

TOOL GEOMETRY ON PROGRAMMING

When programming for CAM, the tool should be considered as a radius cutter. Usually, the corner radius should be set as $R = 1.5$ mm. If a larger radius is used, overcutting will occur. The following table shows the amount left uncut (t_1) and overcut (t_2).

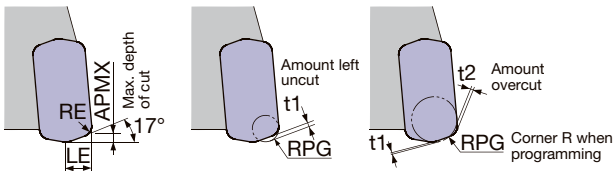

LNMMU0303ZER...

Max. depth of cut APMX (mm)	Corner radius RE (mm)	LE (mm)	Corner R when programming RPG	Amount left uncut t_1 (mm)	Amount overcut t_2 (mm)
1	1.2	3	1	0.6	-
1	1.2	3	1.5	0.5	-
1	1.2	3	2	0.25	0.08
1	1.2	3	2.5	0.14	0.26

LNMMU0303ZER...

Max. depth of cut APMX (mm)	Corner radius RE (mm)	LE (mm)	Corner R when programming RPG	Amount left uncut t_1 (mm)	Amount overcut t_2 (mm)
1	1.2	3	1	0.45	-
1	1.2	3	1.5	0.35	-
1	1.2	3	2	0.2	0.1
1	1.2	3	2.5	0.08	0.29

Note: Each value in table is calculated theoretically at the maximum condition

*Recommended

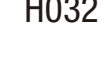
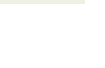
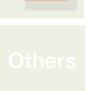
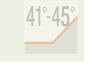

STANDARD CUTTING CONDITIONS

EXN03, HXN03, TXN03

UER type

ISO	Workpiece material	Hardness	Priority	Grade	Chip-breaker	Cutting speed Vc (m/min)	Feed per tooth: fz (mm/t)			ø16, CICT = 2		ø18, CICT = 2		ø20			
							Tool dia.: DCX (mm)			Plunging	n	Vf	n	Vf	n	Vf	
							ø16 - ø22	ø25 - ø50	ø16							ø20	
P	Carbon steels S45C, S55C, etc. C45, C55, etc.	- 300HB	First choice Low resistance	AH3225	MJ ML	100 - 300	0.5 - 1.2	0.5 - 1.5	0.1	3,980	7,960	3,540	7,080	3,180	9,540	12,720	
	Alloy steels SCM440, etc. SCr415, etc.	- 300HB	First choice Low resistance	AH3225	MJ ML	100 - 300	0.5 - 1.2	0.5 - 1.5	0.1	3,980	7,960	3,540	7,080	3,180	9,540	12,720	
M	Prehardened steels NAK80, PX5, etc.	30 - 40HRC	First choice for impact resistance	AH8015 AH3225	MJ MJ	100 - 200	0.5 - 1	0.5 - 1	0.1	2,980	4,770	2,650	4,240	2,390	5,740	7,650	
	Stainless steels SUS304, etc. X5CrNi18-9, etc.	- 200HB	First choice for impact resistance	AH130	ML MJ	80 - 150	0.3 - 1	0.3 - 1	0.1	2,390	2,870	2,120	2,550	1,910	3,440	4,590	
	Precipitation hardening stainless steels SUS630, etc. X5CrNiCuNb16-4, etc.	28HRC - 40HRC	First choice for impact resistance	AH130	ML MJ	80 - 150	0.3 - 0.8	0.3 - 0.8	0.1	2,390	2,390	2,120	2,120	1,910	2,870	3,820	
K	Gray cast irons FC250, etc. 250, etc.	150 - 250HB	First choice for impact resistance	AH8015 AH3225	MJ MJ	100 - 300	0.5 - 1.2	0.5 - 1.5	0.1	3,980	7,960	3,540	7,080	3,180	9,540	12,720	
	Ductile cast irons FCD400, etc. 400-15S, etc.	150 - 250HB	First choice for impact resistance	AH8015 AH3225	MJ MJ	80 - 200	0.5 - 1.2	0.5 - 1.5	0.1	2,980	5,960	2,650	5,300	2,390	7,170	9,560	
S	Titanium alloy Ti-6Al-4V, etc.	- 40HRC	First choice for wear resistance	AH130 AH8015	MJ MJ	30 - 60	0.3 - 0.8	0.3 - 0.8	0.08	800	960	710	860	640	1,160	1,540	
	Heat-resistant alloy Inconel, Hastelloy, etc.	- 40HRC	First choice for impact resistance	AH8015	ML MJ	20 - 50	0.2 - 0.5	0.2 - 0.5	0.05	600	360	530	320	480	440	580	
H	Hot mold steel SKD61, etc. X40CrMoV5-1, etc.	40 - 50HRC	First choice for impact resistance	AH8015 AH3225	MJ MJ	80 - 150	0.1 - 0.5	0.1 - 0.5	0.05	2,390	1,440	2,120	1,280	1,910	1,720	2,300	
	Hot mold steel of D.T.C materials DAC**, DH**, DIEVER, etc.	40 - 50HRC	First choice for impact resistance	AH8015 AH3225	MJ MJ	50 - 100	0.1 - 0.5	0.1 - 0.5	0.05	1,590	960	1,410	850	1,270	1,150	1,530	
	Cold mold steels SKD11, etc. X153CrMoV12, etc.	50 - 60HRC	First choice	AH8005	MJ	50 - 70	0.1 - 0.3	0.1 - 0.3	0.03	1,190	480	1,060	430	950	570	760	

- When chips stay in the cutting zone during slotting or pocketing, use air blast to remove chips from the work area

- Tool overhang length must be as short as possible to avoid chatter. When the tool overhang length is long, decrease the number of revolutions and feed

APPLICATION RANGE

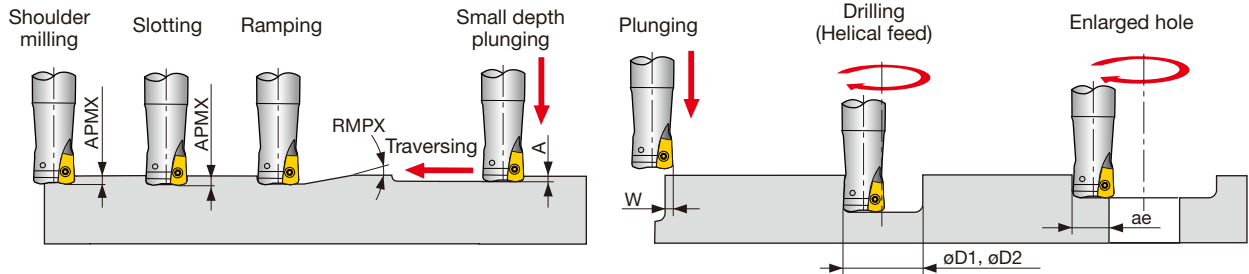

Designation	DCX	Max. depth of cut APMX	Max. ramping angle RMPX	Max. plunging depth A	Max. cutting width in plunging W	Min. machinable hole dia. øD1	Max. machinable hole dia. øD2	Max. cutting width in enlarged hole ae
E/HXN03R016M...	16	0.9	Not possible	Not possible	3.8	Not possible	Not possible	12.2
E/HXN03R018M...	18	0.9	1.7°	0.27	3.8	26	34	14.2
E/HXN03R020M...	20	0.9	1.4°	0.27	3.8	30	38	16.2
E/HXN03R022M...	22	0.9	1.2°	0.27	3.8	34	42	18.2
E/HXN03R025M...	25	0.9	1°	0.27	3.8	40	48	21.2
E/HXN03R028M...	28	0.9	0.8°	0.27	3.8	46	54	24.2
E/HXN03R030M...	30	0.9	0.7°	0.27	3.8	50	58	26.2
E/HXN03R032M...	32	0.9	0.7°	0.27	3.8	54	62	28.2
EXN03R035M...	35	0.9	0.6°	0.27	3.8	60	68	31.2
E/H/TXN03R040M...	40	0.9	0.5°	0.27	3.8	70	78	36.2
TXN03R050M...	50	0.9	0.4°	0.27	3.8	90	98	46.2

For DCX above ø33 mm, slot milling, ramping or contouring is not recommended as chips may be re-cut

Tool dia.: DCX (mm), Number of revolutions: n (min⁻¹), Feed speed: V_f (mm/min), Max. depth of cut: $a_p = 0.5$ mm, Number of teeth: CICT

ø22			ø25			ø28			ø30			ø32			ø35			ø40			ø50		
n	V_f		n	V_f		n	V_f		n	V_f		n	V_f		n	V_f		n	V_f		n	V_f	
	CICT=3	CICT=4		CICT=4	CICT=5		CICT=4	CICT=5		CICT=4	CICT=5		CICT=5	CICT=6		CICT=5	CICT=6		CICT=5	CICT=6		CICT=5	CICT=6
2,890	8,670	11,560	2,550	10,200	12,750	2,270	9,080	11,350	2,120	8,480	10,600	1,990	9,950	11,940	1,820	9,100	10,920	1,590	7,950	9,540	1,270	6,350	10,160
Vc = 200 m/min, fz = 1 mm/t																							
2,890	8,670	11,560	2,550	10,200	12,750	2,270	9,080	11,350	2,120	8,480	10,600	1,990	9,950	11,940	1,820	9,100	10,920	1,590	7,950	9,540	1,270	6,350	10,160
Vc = 200 m/min, fz = 1 mm/t																							
2,170	5,210	6,950	1,910	6,120	7,640	1,710	5,480	6,840	1,590	5,090	6,360	1,490	5,960	7,160	1,360	5,440	6,530	1,190	4,760	5,720	950	3,800	6,080
Vc = 150 m/min, fz = 0.8 mm/t																							
1,740	3,140	4,180	1,530	3,680	4,590	1,360	3,270	4,080	1,270	3,050	3,810	1,190	3,570	4,290	1,090	3,270	3,930	950	2,850	3,420	760	2,280	3,650
Vc = 120 m/min, fz = 0.6 mm/t																							
1,740	2,610	3,480	1,530	3,060	3,830	1,360	2,720	3,400	1,270	2,540	3,180	1,190	2,980	3,570	1,090	2,730	3,270	950	2,380	2,850	760	1,900	3,040
Vc = 120 m/min, fz = 0.5 mm/t																							
1,450	1,740	2,320	1,270	2,040	2,540	1,140	1,830	2,280	1,060	1,700	2,120	990	1,980	2,380	910	1,820	2,190	800	1,600	1,920	640	1,280	2,050
Vc = 100 m/min, fz = 0.4 mm/t																							
2,890	8,670	11,560	2,550	10,200	12,750	2,270	9,080	11,350	2,120	8,480	10,600	1,990	9,950	11,940	1,820	9,100	10,920	1,590	7,950	9,540	1,270	6,350	10,160
Vc = 200 m/min, fz = 1 mm/t																							
2,170	6,510	8,680	1,910	7,640	9,550	1,710	6,840	8,550	1,590	6,360	7,950	1,490	7,450	8,940	1,360	6,800	8,160	1,190	5,950	7,140	950	4,750	7,600
Vc = 150 m/min, fz = 1 mm/t																							
580	1,050	1,400	510	1,230	1,530	450	1,080	1,350	420	1,010	1,260	400	1,200	1,440	360	1,080	1,300	320	960	1,160	250	750	1,200
Vc = 40 m/min, fz = 0.6 mm/t																							
430	390	520	380	460	570	340	410	510	320	390	480	300	450	540	270	410	490	240	360	440	190	290	460
Vc = 30 m/min, fz = 0.3 mm/t																							
1,740	1,570	2,090	1,530	1,840	2,300	1,360	1,640	2,040	1,270	1,530	1,910	1,190	1,790	2,150	1,090	1,640	1,970	950	1,430	1,710	760	1,140	1,830
Vc = 120 m/min, fz = 0.3 mm/t																							
1,160	1,050	1,400	1,020	1,230	1,530	910	1,100	1,370	850	1,020	1,280	800	1,200	1,440	730	1,100	1,320	640	960	1,160	510	770	1,230
Vc = 80 m/min, fz = 0.3 mm/t																							
870	530	700	760	610	760	680	550	680	640	520	640	600	600	720	550	550	660	480	480	580	380	380	610
Vc = 60 m/min, fz = 0.2 mm/t																							

- The above table shows the conditions for standard shank type cutters. When using long shank type cutters, the number of teeth may be different.
- Cutting conditions are generally limited by the rigidity and power of the machine and the

rigidity of the workpiece. When setting the conditions, start from half of the values of the standard cutting conditions and then increase the value gradually while making sure the machine is running normally

TOOL GEOMETRY ON PROGRAMMING

When programming for CAM, the tool should be considered as a radius cutter. Usually, the corner radius should be set as $R = 1.5$ mm. If a larger radius is used, overcutting will occur. The following table shows the amount left uncut (t_1) and overcut (t_2).

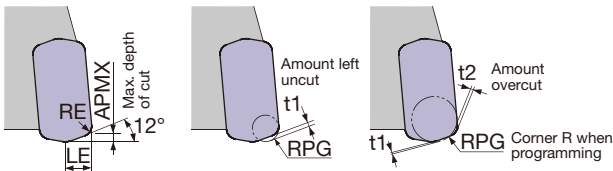

LNMU0303UER...

Max. depth of cut APMX (mm)	Corner radius RE (mm)	LE (mm)	Corner R when programming RPG	Amount left uncut t1 (mm)	Amount overcut t2 (mm)
0.9	1	3.5	1	0.48	-
0.9	1	3.5	1.5	0.39	-
0.9	1	3.5	2	0.3	0.12
0.9	1	3.5	2.5	0.21	0.31

Note: Each value in table is calculated theoretically at the maximum condition.

*Recommended



STANDARD CUTTING CONDITIONS

EXN06, TXN06



ISO	Workpiece materials	Hardness	Priority	Grade	Chip-breaker	Cutting speed Vc (m/min)	Feed per tooth: fz (mm/t)		ø32, CICT = 2 ø35, CICT = 2 ø40, CICT = 3					
							Tool dia.: DCX (mm)	Plunging	ø32		ø35		ø40	
									n	Vf	n	Vf	n	Vf
P	Carbon steels S45C, S55C, etc. C45, C55, etc.	- 300HB	First choice	AH3225	MJ	100 - 300	0.5 - 1.5	0.15	1,990	3,980	1,820	3,640	1,590	4,770
	Alloy steels SCM440, etc. SCr415, etc.	- 300HB	First choice	AH3225	MJ	100 - 200	0.5 - 1.5	0.15	1,990	3,980	1,820	3,640	1,590	4,770
	Prehardened steels NAK80, PX5, etc.	30 - 40HRC	First choice	AH3225	MJ	100 - 200	0.5 - 1.2	0.15	1,490	2,380	1,360	2,180	1,190	2,860
M	Stainless steels SUS304, etc. X5CrNi18-9, etc.	- 200HB	First choice	AH130	ML	80 - 150	0.3 - 0.8	0.1	1,190	1,430	1,090	1,310	950	1,710
	Precipitation hardening stainless steels SUS630, etc.	28HRC - (H1150)	First choice for impact resistance	AH130	MJ	80 - 150	0.2 - 0.5	0.1	1,190	710	1,090	650	960	860
	X5CrNiCuNb16-4, etc.	40HRC - (H900)	First choice for impact resistance	AH130	ML	80 - 120	0.1 - 0.3	0.1	1,000	400	910	360	800	480
K	Gray cast irons FC250, etc. 250, etc.	150 - 250HB	First choice	AH120	MJ	100 - 300	0.5 - 1.5	0.15	1,990	3,980	1,820	3,640	1,590	4,770
		150 - 250HB	First choice	AH120	MJ	80 - 200	0.5 - 1.5	0.15	1,490	2,980	1,360	2,720	1,190	3,570
S	Titanium alloy Ti-6Al-4V, etc.	- 40HRC	First choice for impact resistance	AH130	ML	30 - 60	0.3 - 0.7	0.08	400	400	360	360	320	480
	Heat-resistant alloy Inconel, Hastelloy, etc.	- 40HRC	First choice for impact resistance	AH8015	ML	20 - 50	0.1 - 0.3	0.05	300	120	270	110	240	140
H	Hot mold steel SKD61, etc. X40CrMoV5-1, etc.	40 - 55HRC	First choice	AH8015	MH	80 - 150	0.1 - 0.5	0.05	1,190	710	1,090	650	950	850
	Hot mold steel of D.T.C materials DAC**, DH**, DIEVER, etc	40 - 55HRC	Low resistance	AH8015	MJ	50-100	0.1 - 0.3	0.05	800	320	730	290	640	380
		40 - 55HRC	First choice for impact resistance	AH8015	MH		50-100		0.1 - 0.5	600	120	550	110	480
	Cold mold steels SKD11, etc. X153CrMoV12, etc.	55 - 60HRC	First choice	AH8005	MH	50 - 70	0.05 - 0.3	0.03	600	60	550	55	480	70

- The above table shows the conditions for standard shank type cutters. When using long shank type cutters, the number of teeth may be different.
 - Cutting conditions are generally limited by the rigidity and power of the machine

and the rigidity of the workpiece. When setting the conditions, start from half of the values of the standard cutting conditions and then increase the value gradually while making sure the machine is running normally

Approach angle

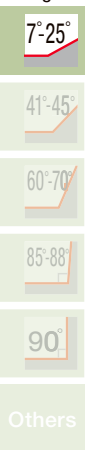

Others

APPLICATION RANGE

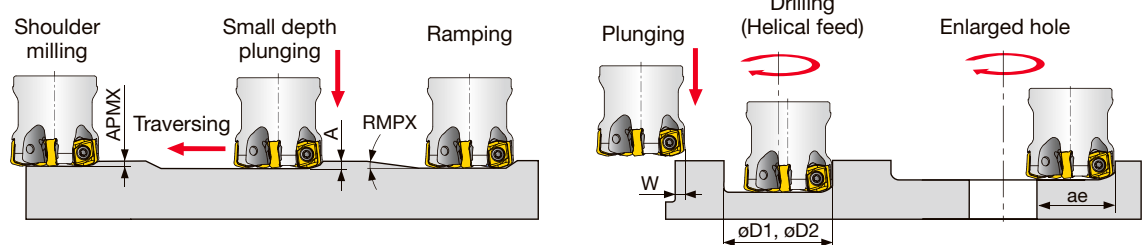

Designation	DCX	Max. depth of cut APMX	Max. ramping angle RMPX		Max. plunging depth A	Max. cutting width in plunging W	Min. machinable hole dia. øD1	Max. machinable hole dia. øD2	Max. cutting width in enlarged hole ae	
			MJ/ML	MH						
			MJ/ML	MH						
EXN06R032M...	32	1.5	2	1.4	0.5	0.4	6	47	59	25
EXN06R035M...	35	1.5	1.7	1.1	0.5	0.4	6	53	65	28
EXN06R040M...	40	1.5	1.3	0.8	0.5	0.4	6	63	75	33
TXN06R050M...	50	1.5	0.9	0.7	0.5	0.4	6	83	95	43
TXN06R052M...	52	1.5	0.8	0.6	0.5	0.4	6	87	99	45
TXN06R063M...	63	1.5	0.6	0.5	0.5	0.4	6	109	121	56
TXN06R066M...	66	1.5	0.5	0.5	0.5	0.4	6	115	127	59
TXN06R080M...	80	1.5	0.5	0.3	0.5	0.4	6	143	155	73
TXN06R100M...	100	1.5	0.34	0.25	0.5	0.4	6	183	195	93
TXN06R125M...	120	1.5	0.26	0.2	0.5	0.4	6	233	245	118
TXN06R160M...	160	1.5	0.2	0.15	0.5	0.4	6	303	315	153
TXN06R200M...	200	1.5	0.15	0.11	0.5	0.4	6	383	395	193

For DCX above 100 mm, slot milling, ramping or contouring is not recommended as chips may be re-cut.



Tool dia.: DCX (mm), Number of revolutions: n (min⁻¹), Feed speed: V_f (mm/min), Max. depth of cut: $a_p = 1.5$ mm, Number of teeth: CICT

ø50			ø63			ø80			ø100, CICT = 6		ø125, CICT = 8		ø160, CICT = 10		ø200, CICT = 12	
n	V_f		n	V_f		n	V_f		n	V_f	n	V_f	n	V_f	n	V_f
	CICT = 4	CICT = 5		CICT = 4	CICT = 6		CICT = 5	CICT = 8								
1,270	5,080	6,350	1,010	4,040	6,060	800	4,000	6,400	640	3,820	510	4,080	400	3,980	320	3,820
Vc = 200 m/min, fz = 1.0 mm/t																
1,270	5,080	6,350	1,010	4,040	6,060	800	4,000	6,400	640	3,820	510	4,080	400	3,980	320	3,820
Vc = 200 m/min, fz = 1.0 mm/t																
950	3,040	3,800	760	2,430	3,650	600	2,400	3,840	480	2,290	380	2,450	300	2,390	240	2,290
Vc = 150 m/min, fz = 0.8 mm/t																
950	3,800	4,750	760	3,040	4,560	600	3,000	4,800	480	2,880	380	3,040	300	3,000	240	2,880
Vc = 150 m/min, fz = 1.0 mm/t																
760	1,820	2,280	610	1,470	2,200	480	1,440	2,300	380	1,380	310	1,470	240	1,430	190	1,380
Vc = 120 m/min, fz = 0.6 mm/t																
760	910	1,140	610	730	1,100	480	720	1,150	380	680	310	740	240	720	190	680
Vc = 120 m/min, fz = 0.3 mm/t																
640	510	640	510	410	610	400	400	640	320	380	260	420	200	400	160	380
Vc = 100 m/min, fz = 0.2 mm/t																
1,270	5,080	6,350	1,010	4,040	6,060	800	4,000	6,400	640	3,820	510	4,080	400	3,980	320	3,820
Vc = 200 m/min, fz = 1.0 mm/t																
950	3,800	4,750	760	3,040	4,560	600	3,000	4,800	480	2,870	380	3,060	300	2,990	240	2,870
Vc = 150 m/min, fz = 1.0 mm/t																
250	500	630	200	400	600	160	400	640	130	380	100	410	80	400	60	380
Vc = 40 m/min, fz = 0.5 mm/t																
190	150	190	150	120	180	120	120	190	100	120	80	120	60	120	50	120
Vc = 30 m/min, fz = 0.2 mm/t																
760	910	1,140	610	730	1,100	480	720	1,150	380	680	310	740	240	720	190	680
Vc = 120 m/min, fz = 0.3 mm/t																
510	410	510	400	320	480	320	320	510	250	300	200	320	160	320	130	310
Vc = 80 m/min, fz = 0.2 mm/t																
380	150	190	300	120	180	240	120	190	190	110	150	120	120	120	100	120
Vc = 60 m/min, fz = 0.1 mm/t																
380	75	95	300	60	90	240	60	95	190	55	150	60	120	60	100	60
Vc = 60 m/min, fz = 0.05 mm/t																

TOOL GEOMETRY ON PROGRAMMING

When programming for CAM, the tool should be considered as a radius cutter. Usually, the corner radius should be set as R = 3 mm. If a larger radius is used, overcutting will occur. The following table shows the amount left uncut (t1) and overcut (t2).

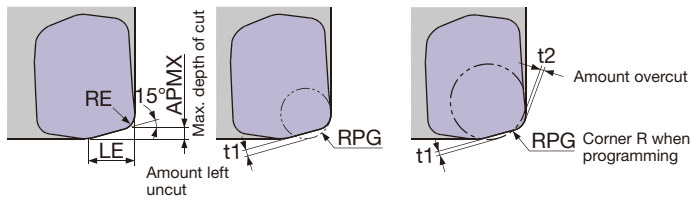

LNMU06...

Max. depth of cut APMX (mm)	Corner radius RE (mm)	LE (mm)	Corner R when programming RPG	Amount left uncut t1 (mm)	Amount overcut t2 (mm)
1.5	2	6	2	1	-
			3	0.77	-
			4	0.54	0.26

LNGU06...MH

Max. depth of cut APMX (mm)	Corner radius RE (mm)	LE (mm)	Corner R when programming RPG	Amount left uncut t1 (mm)	Amount overcut t2 (mm)
1.5	2	6	2	0.9	-
			3	0.66	-
			4	0.41	0.26

Note: Each value in table is calculated theoretically at the maximum condition.
*Recommended



High Feed
Milling

TUNGFLEX

SM

Steel modular shank

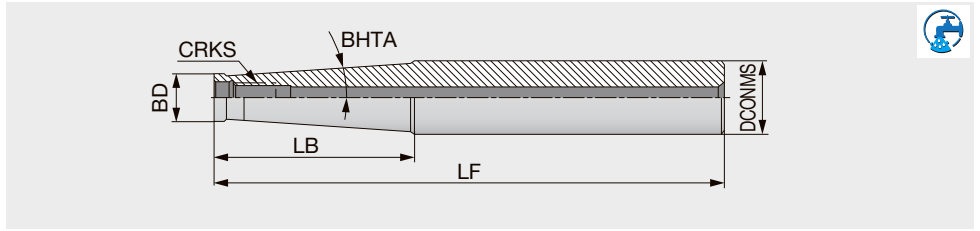

Face Milling



Shoulder Milling



Slot Milling



Profile Milling



Chamfering,
Counterbore



Finish
Face Milling

Designation	CRKS	DCONMS	LF	LB	BD	BHTA	Shank type
SM06-L60C10	M6	10	60	20	9.7	0°	Cylindrical
SM06-L105-C12	M6	12	105	60	9.7	1.2°	Cylindrical
SM06-L125-C16	M6	16	125	60	9.7	3.3°	Cylindrical
SM08-L73C16	M8	16	73	25	13	0°	Cylindrical
SM08-L128-C16	M8	16	128	80	13	0.9°	Cylindrical
SM08-L170-C20	M8	20	170	66.8	13	3.3°	Cylindrical
SM10-L80C20	M10	20	80	30	18	0°	Cylindrical
SM10-L130-C20	M10	20	130	80	18	0.6°	Cylindrical
SM10-L200-C25	M10	25	200	57.2	19	3.3°	Cylindrical
SM12-L86-C25	M12	25	86	30	21	5.1°	Cylindrical
SM12-L200-C32	M12	32	200	78	21	4.4°	Cylindrical
SM16-L95-C32	M16	32	95	35	29	1.7°	Cylindrical
SM16-L230-C32	M16	32	230	50	29	1.8°	Cylindrical

Approach
angle

7°-25°

41°-45°

60°-70°

85-88°

90°

Others

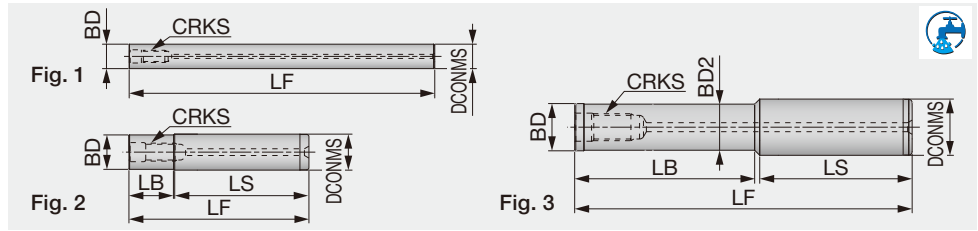

Designation	CRKS	DCONMS	LF	LB	LS	BD	BD2	Fig.
SM06-L100-C10-C-H	M6	10	100	-	-	10	-	1
SM06-L150-C10-C-H	M6	10	150	-	-	10	-	1
SM06-L100-C12-C-H	M6	12	100	-	-	12	-	1
SM06-L150-C12-C-H	M6	12	150	-	-	12	-	1
SM08-L80-20-C16-C-H	M8	16	80	20	59.6	15.3	-	2
SM08-L100-40-C16-C-H	M8	16	100	40	59.6	15.3	-	2
SM08-L150-80-C16-C-H	M8	16	150	80	69.6	15.3	-	2
SM08-L200-100-C16-C-H	M8	16	200	100	98.2	13	12.5	3
SM08-L200-140-C16-C-H	M8	16	200	140	59.6	15.3	-	2
SM08-L250-180-C16-C-H	M8	16	250	180	69.6	15.3	-	2
SM10-L80-20-C20-C-H	M10	20	80	20	59.2	18.5	-	2
SM10-L100-40-C20-C-H	M10	20	100	40	59.2	18.5	-	2
SM10-L150-80-C20-C-H	M10	20	150	80	69.2	18.5	-	2
SM10-L200-100-C20-C-H	M10	20	200	100	99.2	18.5	-	2
SM10-L200-140-C20-C-H	M10	20	200	140	58.7	18	17.5	3
SM10-L200-140-C20-C-H-N	M10	20	200	140	59.2	18.5	-	2
SM10-L250-130-C20-C-H	M10	20	250	130	118.7	18	17.5	3
SM10-L250-180-C20-C-H	M10	20	250	180	68.7	18	17.5	3
SM10-L250-180-C20-C-H-N	M10	20	250	180	69.2	18.5	-	2
SM10-L300-180-C20-C-H	M10	20	300	180	118.7	18	17.5	3
SM10-L300-230-C20-C-H	M10	20	300	230	68.7	18	17.5	3
SM12-L100-40-C25-C-H	M12	25	100	40	59.5	24	-	2
SM12-L150-80-C25-C-H	M12	25	150	80	67.7	21	20.5	3
SM12-L150-80-C25-C-H-N	M12	25	150	80	69.5	24	-	2
SM12-L200-100-C25-C-H	M12	25	200	100	97.7	21	20.5	3
SM12-L200-100-C25-C-H-N	M12	25	200	100	99.5	24	-	2
SM12-L200-140-C25-C-H	M12	25	200	140	57.7	21	20.5	3
SM12-L250-130-C25-C-H	M12	25	250	130	117.7	21	20.5	3
SM12-L250-180-C25-C-H	M12	25	250	180	69.5	24	-	2
SM12-L300-180-C25-C-H	M12	25	300	180	117.7	21	20.5	3
SM12-L300-180-C25-C-H-N	M12	25	300	180	119.5	24	-	2
SM12-L300-230-C25-C-H	M12	25	300	230	67.7	21	20.5	3
SM16-L100-40-C32-C-H	M16	32	100	40	58.5	29	-	2
SM16-L150-80-C32-C-H	M16	32	150	80	68.5	29	-	2
SM16-L200-100-C32-C-H	M16	32	200	100	98.5	29	-	2
SM16-L200-140-C32-C-H	M16	32	200	140	58.5	29	-	2
SM16-L250-130-C32-C-H	M16	32	250	130	118.5	29	-	2
SM16-L250-180-C32-C-H	M16	32	250	180	68.5	29	-	2
SM16-L300-180-C32-C-H	M16	32	300	180	118.5	29	-	2
SM16-L300-230-C32-C-H	M16	32	300	230	68.5	29	-	2
SM16-L350-230-C32-C-H	M16	32	350	230	118.5	29	-	2
SM16-L350-280-C32-C-H	M16	32	350	280	68.5	29	-	2

Cylindrical type holder for high-feed milling, screw-on

GAMP = +4°, GAMF = -21° ~ -17°

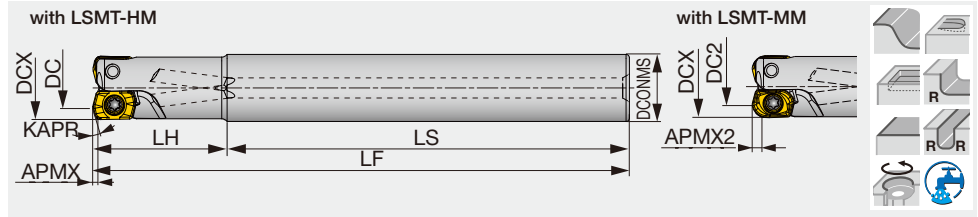

Designation	APMX	APMX2	DCX	CICT	DC	DC2	DCONMS	LS	LH	LF	KAPR	WT (kg)	Air hole	Insert
EXLS02M008C08.0LH16R01	0.5	2	8	1	4.29	4	8	59	16	75	12°	0.02	With	LSMT02...
EXLS02M008C08.0LH30R01	0.5	2	8	1	4.29	4	8	59	31	90	12°	0.03	With	LSMT02...
EXLS02M010C10.0LH20R02	0.5	2	10	2	6.28	6	10	60	20	80	12°	0.04	With	LSMT02...
EXLS02M010C10.0LH40R02	0.5	2	10	2	6.28	6	10	60	40	100	12°	0.05	With	LSMT02...
EXLS02M010C08.0LH20R02	0.5	2	10	2	6.28	6	8	60	20	80	12°	0.03	With	LSMT02...
EXLS02M012C12.0LH20R03	0.5	2	12	3	8.31	8	12	60	20	80	12°	0.06	With	LSMT02...
EXLS02M012C12.0LH50R02	0.5	2	12	2	8.31	8	12	60	50	110	12°	0.08	With	LSMT02...
EXLS02M012C10.0LH20R03	0.5	2	12	3	8.31	8	10	60	20	80	12°	0.04	With	LSMT02...
EXLS02M016C16.0LH30R05	0.5	2	16	5	12.31	12	16	70	30	100	12°	0.14	With	LSMT02...
EXLS02M016C16.0LH50R03	0.5	2	16	3	12.31	12	16	70	50	120	12°	0.17	With	LSMT02...
EXLS02M020C20.0LH50R05	0.5	2	20	5	16.29	16	20	80	50	130	12°	0.27	With	LSMT02...
EXLS02M020C20.0LH50R06	0.5	2	20	6	16.29	16	20	80	50	130	12°	0.27	With	LSMT02...
EXLS02M020C20.0LH80R05	0.5	2	20	5	16.29	16	20	80	80	160	12°	0.33	With	LSMT02...
EXLS02M025C25.0LH60R06	0.5	2	25	6	21.28	21	25	80	60	140	12°	0.45	With	LSMT02...
EXLS02M025C25.0LH60R08	0.5	2	25	8	21.28	21	25	80	60	140	12°	0.47	With	LSMT02...
EXLS02M025C25.0LH100R06	0.5	2	25	6	21.28	21	25	80	100	180	12°	0.57	With	LSMT02...

HXLS

Modular head for high-feed milling, screw-on (TungFlex)

GAMP = +4°, GAMF = -21° ~ -17°

- Approach angle
- 7°-25°
- 41°-45°
- 60°-70°
- 85°-88°
- 90°
- Others

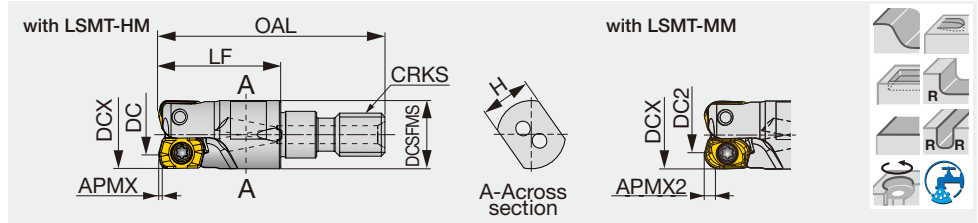

Designation	APMX	APMX2	DCX	CICT	DC	DC2	OAL	LF	H	DCSFMS	CRKS	KAPR	WT (kg)	Air hole	Insert
HXLS02M008M06R01	0.5	2	8	1	4.29	4	33.5	19	7	9.5	M6	12°	0.01	With	LSMT02...
HXLS02M010M06R02	0.5	2	10	2	6.28	6	31.5	17	7	9.5	M6	12°	0.01	With	LSMT02...
HXLS02M012M06R03	0.5	2	12	3	8.31	8	31.5	17	7	10	M6	12°	0.01	With	LSMT02...
HXLS02M012M06R02	0.5	2	12	2	8.31	8	31.5	17	7	10	M6	12°	0.01	With	LSMT02...
HXLS02M016M08R05	0.5	2	16	5	12.31	12	40	23	10	13	M8	12°	0.03	With	LSMT02...
HXLS02M016M08R03	0.5	2	16	3	12.31	12	40	23	10	13	M8	12°	0.03	With	LSMT02...
HXLS02M020M10R05	0.5	2	20	5	16.29	16	49	30	15	17.8	M10	12°	0.05	With	LSMT02...
HXLS02M020M10R06	0.5	2	20	6	16.9	16	49	30	15	17.8	M10	12°	0.05	With	LSMT02...
HXLS02M025M12R06	0.5	2	25	6	21.28	21	52	30	17	20.8	M12	12°	0.08	With	LSMT02...
HXLS02M025M12R08	0.5	2	25	8	21.28	21	52	30	17	20.8	M12	12°	0.08	With	LSMT02...

SPARE PARTS

Designation	Clamping screw	Lubricant	Wrench
EXLS02M..., HXLS02M...	CSPB-2H	M-1000	IP-6DB

Recommended clamping torque: 0.7 N·m

Reference pages: Standard cutting conditions → **H040 - H041**, TungFlex → **H036 - H037**

INSERT

LSMT-HM (High feed)

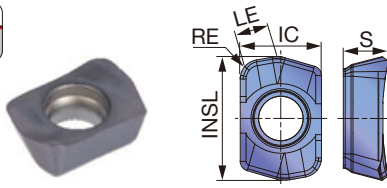

LSMT-MM (Radius)

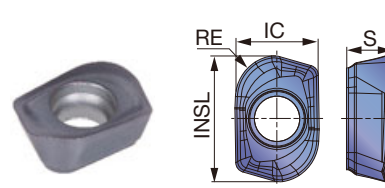

P Steel	★ ☆								
M Stainless	★								
K Cast iron	☆ ★								
N Non-ferrous									
S Superalloys	☆ ★								
H Hard materials	★								

★ : First choice
☆ : Second choice

Designation	RE	APMX	Coated						LE	INSL	IC	S
			AH3225	AH8015								
LSMT0202ZER-HM	1	0.5	● ●						1.7	6.4	4.2	2.3
LSMT0202R2-MM	2	2	● ●						-	6.4	4.3	2.3

● : Line up

APPLICATION

LSMT-HM

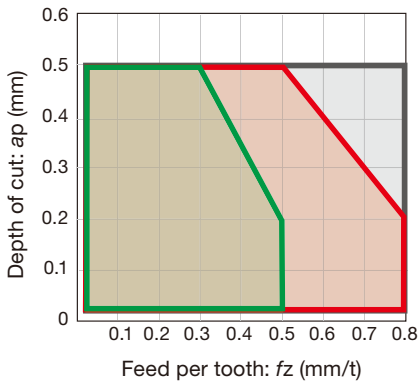

- For standard shanks in $\leq 3xD$
- For long-neck shanks in $\geq 4xD$
- For modular head shanks in $\geq 7xD$

LSMT-MM

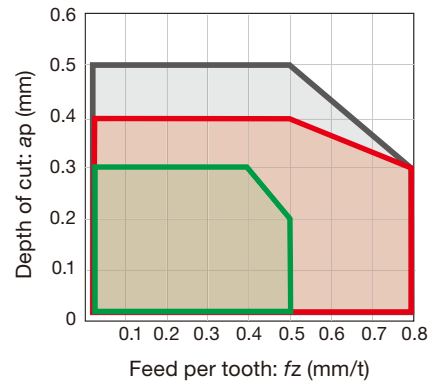

- For standard shanks in $\leq 3xD$
- For long-neck shanks in $\geq 4xD$
- For modular head shanks in $\geq 7xD$

* When the DOC is 0.5 mm or more, the feed less than 0.15 mm/t is recommended.

Grade
Insert
Ext. Toolholder
Int. Toolholder
Threading
Grooving
Miniature tool
Milling cutter
Endmill
Drilling tool
Tooling System
User's Guide
Index

A
B
C
D
E
F
G
H
I
J
K
L
M



STANDARD CUTTING CONDITIONS



ISO	Workpiece materials	Hardness	Priority	Grades	Cutting speed Vc (m/min)	Feed per tooth fz (mm/t)	
P	Carbon steels S45C, S55C, etc. C45, S55C, etc.	- 300HB	First choice	AH3225	100 - 300	0.2 - 0.8	
		- 300HB	For wear resistance	AH8015	100 - 300	0.2 - 0.8	
	Alloy steels SCM440, 42CrMo4, etc. 42CrMo4, 17Cr3, etc.	- 300HB	First choice	AH3225	100 - 300	0.2 - 0.8	
		- 300HB	For wear resistance	AH8015	100 - 300	0.2 - 0.8	
	Prehardened steels NAK80, PX5, etc.	30 - 40HRC	First choice	AH8015	100 - 200	0.2 - 0.5	
M	Stainless steels SUS304, SUS316, etc. X5CrNi18-9, X5CrNiMo17-12-3, etc.	- 200HB	First choice	AH3225	100 - 150	0.2 - 0.5	
		30 - 40HRC	For impact resistance	AH3225	100 - 200	0.2 - 0.5	
K	Gray cast irons FC250, FC300, etc. 200, 300, etc.	150 - 250HB	First choice	AH8015	100 - 300	0.2 - 0.8	
		150 - 250HB	For impact resistance	AH3225	100 - 300	0.2 - 0.8	
	Ductile cast irons FCD600, etc. 600-3, etc.	150 - 250HB	First choice	AH8015	80 - 200	0.2 - 0.8	
		150 - 250HB	For impact resistance	AH3225	80 - 200	0.2 - 0.8	
S	Titanium alloy Ti-6Al-4V, etc.	- 40HRC	First choice	AH3225	30 - 60	0.1 - 0.3	
		- 40HRC	For wear resistance	AH8015	30 - 60	0.1 - 0.3	
	Heat resistance alloy Inconel, Hastelloy, etc.	- 40HRC	First choice	AH8015	20 - 50	0.1 - 0.3	
		- 40HRC	For impact resistance	AH3225	20 - 50	0.1 - 0.3	
H	Hardened steel	SKD61, etc. X40CrMoV5-1, etc.	40 - 50HRC	First choice	AH8015	80 - 150	0.1 - 0.5
		SKD11, etc. X153CrMoV12, etc.	50 - 60HRC	First choice	AH8015	50 - 70	0.1 - 0.3



APPLICATION RANGE

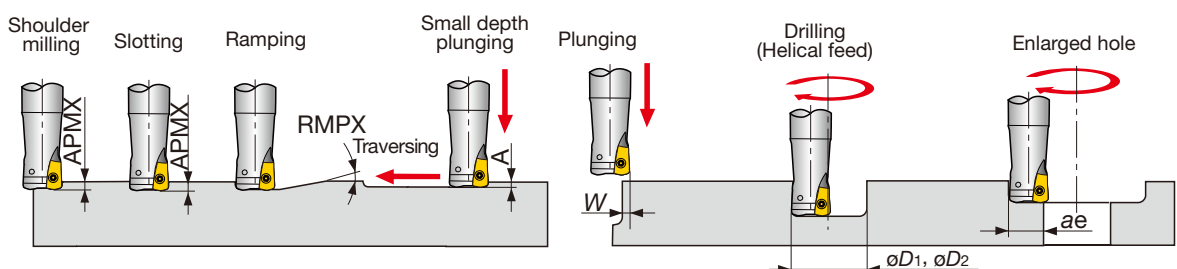

Designation	DC	Max. depth of cut		RMPX	Max. plunging depth	Max. cutting width in plunging	Min. machining	Max. machining	Max. cutting width in enlarged hole
		APMX	APMX2						
E/HXLS02M008...	8	0.5	2	4°	0.2	2	10	15	5.9
E/HXLS02M010...	10	0.5	2	3.3°	0.2	2	14	19	7.9
E/HXLS02M012...	12	0.5	2	2°	0.2	2	18	23	9.9
E/HXLS02M016...	16	0.5	2	1.3°	0.2	2	26	31	13.9
E/HXLS02M020...	20	0.5	2	1.2°	0.2	2	34	39	17.9
E/HXLS02M025...	25	0.5	2	1°	0.2	2	44	49	22.9

APMX: with LSMT-HM, APMX2: with LSMT-MM

Tool geometry on programming

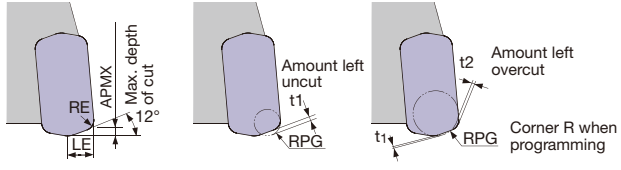

LSMT...-HM

Corner R when programming: RPG	Amount left uncut t1 (mm)	Amount left overcut t2 (mm)
1	0.162	0
1.5	0.07	0.14
2	0	0.34

*Recommended

Tool dia.: ϕD_c (mm), Number of revolutions: n (min ⁻¹), Feed speed: V_f (mm/min), Max. depth of cut: $a_p = 0.5$ mm, Number of teeth: CICT															
$\phi 8$, CICT = 1		$\phi 10$, CICT = 2		$\phi 12$			$\phi 16$			$\phi 20$			$\phi 25$		
n	V_f	n	V_f	n	V_f		n	V_f		n	V_f		n	V_f	
					CICT = 2	CICT = 3		CICT = 3	CICT = 5		CICT = 5	CICT = 6		CICT = 6	CICT = 8
7,960	3,980	6,370	6,370	5,310	5,310	7,970	3,980	5,970	9,950	3,180	7,950	9,540	2,550	7,650	10,200
V _c = 200 m/min, f _z = 0.5 mm/t															
7,960	3,980	6,370	6,370	5,310	5,310	7,970	3,980	5,970	9,950	3,180	7,950	9,540	2,550	7,650	10,200
V _c = 200 m/min, f _z = 0.5 mm/t															
5,970	2,390	4,780	3,820	3,980	3,180	4,780	2,990	3,590	5,980	2,390	4,780	5,740	1,910	4,590	6,120
V _c = 150 m/min, f _z = 0.4 mm/t															
4,780	1,910	3,820	3,060	3,190	2,550	3,830	2,390	2,870	4,780	1,910	3,820	4,590	1,530	3,680	4,900
V _c = 120 m/min, f _z = 0.4 mm/t															
7,960	3,980	6,370	6,370	5,310	5,310	7,970	3,980	5,970	9,950	3,180	7,950	9,540	2,550	7,650	10,200
V _c = 200 m/min, f _z = 0.5 mm/t															
5,970	2,990	4,780	4,780	3,980	3,980	5,970	2,990	4,490	7,480	2,390	5,980	7,170	1,530	4,590	6,120
V _c = 150 m/min, f _z = 0.5 mm/t															
1,590	320	1,270	510	1,060	420	640	800	480	800	640	640	770	510	620	820
V _c = 40 m/min, f _z = 0.2 mm/t															
1,190	240	1,000	400	800	320	480	600	360	600	480	480	580	380	460	460
V _c = 30 m/min, f _z = 0.2 mm/t															
4,780	1,430	3,820	2,290	3,190	1,910	2,870	2,390	2,150	3,590	1,910	2,870	3,440	1,530	2,760	3,680
V _c = 120 m/min, f _z = 0.3 mm/t															
2,390	480	1,910	760	1,590	640	950	1,190	710	1,190	950	950	1,140	760	920	1,220
V _c = 60 m/min, f _z = 0.2 mm/t															

Grade
Insert
Ext. Toolholder
Int. Toolholder
Threading
Grooving
Miniature tool
Milling cutter
Endmill
Drilling tool
Tooling System
User's Guide
Index



High feed endmill, shank type, with screw clamp system

GAMP = +23°, GAMF = -7.9° ~ -6.2°

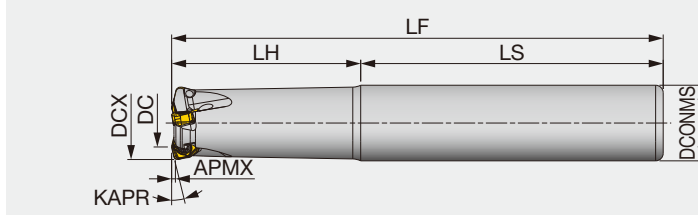

Designation	APMX	DCX	CICT	DC	DCONMS	LS	LH	LF	KAPR	WT(kg)	Air hole	Insert
EXWX03M016C16.0R02	1	16	2	8.9	16	70	30	100	12°	0.14	With	WXMU03...
EXWX03M016C16.0R02L	1	16	2	8.9	16	100	50	150	12°	0.21	With	WXMU03...
EXWX03M020C20.0R03	1	20	3	12.8	20	80	50	130	12°	0.26	With	WXMU03...
EXWX03M020C20.0R03L	1	20	3	12.8	20	80	80	160	12°	0.31	With	WXMU03...
EXWX03M025C25.0R04	1	25	4	17.8	25	80	60	140	12°	0.46	With	WXMU03...
EXWX03M025C25.0R04L	1	25	4	17.8	25	80	100	180	12°	0.58	With	WXMU03...
EXWX03M032C32.0R05	1	32	5	24.7	32	80	70	150	12°	0.84	With	WXMU03...
EXWX03M032C32.0R05L	1	32	5	24.7	32	80	120	200	12°	1.11	With	WXMU03...

HXWX03-M

High feed endmill, modular type (TungFlex)

GAMP = +23°, GAMF = -7.9° ~ -6.2°

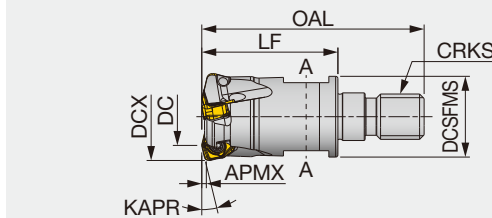

A-A cross section

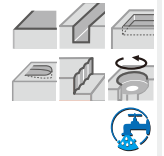

Designation	APMX	DCX	CICT	DC	OAL	LF	H	DCSFMS	KAPR	CRKS	WT(kg)	Air hole	Insert
HXWX03M016M08R02	1	16	2	8.9	42	25	10	12.8	12°	M8	0.03	With	WXMU03...
HXWX03M020M10R03	1	20	3	12.8	49	30	15	17.8	12°	M10	0.06	With	WXMU03...
HXWX03M025M12R04	1	25	4	17.8	57	35	17	20.8	12°	M12	0.1	With	WXMU03...
HXWX03M032M16R05	1	32	5	24.7	63	40	22	28.8	12°	M16	0.21	With	WXMU03...

SPARE PARTS



Designation	Clamping screw	Wrench
EXWX03..., HXWX03...	CSPB-2.5SH	IP-7D

Recommended clamping torque: 1.1 N·m

Reference pages: Standard cutting conditions → **H044 - H045**, TungFlex → **H036 - H037**

High feed bore type milling with screw clamp system

GAMP = +23°, GAMF = -6.2° ~ -6.1°

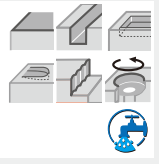
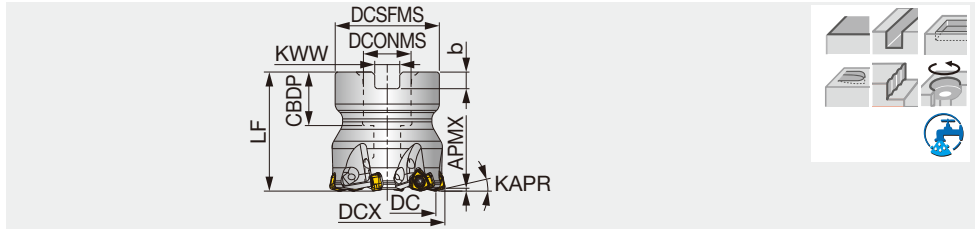

Designation	APMX	DCX	CICT	DC	DCSFMS	DCONMS	CBDP	LF	b	KWW	KAPR	WT(kg)	Air hole	Insert
TXWX03M040B16.0R06	1	40	6	32.7	35	16	18	40	5.6	8.4	12°	0.22	With	WXMU03...
TXWX03M050B22.0R08	1	50	8	42.7	47	22	20	50	6.3	10.4	12°	0.46	With	WXMU03...

SPARE PARTS



Designation	Clamping screw	Shell locking bolt	Wrench
EXWX03M...	CSPB-2.5SH	-	IP-7D
TXWX03M040B16.0R06	CSPB-2.5SH	CM8X30H	IP-7D
TXWX03M050B22.0R08	CSPB-2.5SH	CM10X30H	IP-7D

Recommended clamping torque: 1.1 N·m

INSERT

WXMU0303-MM

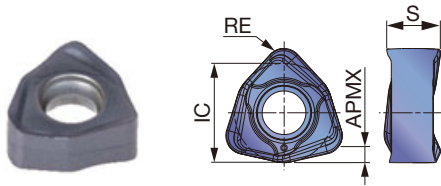

P	Steel	★	☆											
M	Stainless	★												
K	Cast iron	☆	★											
N	Non-ferrous													
S	Superalloy	☆	★											
H	Hard materials		★											

★ : First choice
☆ : Second choice

Designation	RE	APMX	Coated		IC	S
			AH3225	AH8015		
WXMU0303ZER-MM	1.2	1	●	●	6.35	3.63

● : Line up





STANDARD CUTTING CONDITIONS

ISO	Workpiece materials	Hardness	Priority	Grades	Chipbreaker	Cutting speed Vc (m/min)	Feed per tooth fz (mm/t)
P	Low carbon steel S15C, SS400, etc. C15E4, E275A, etc.	- 300HB	First choice	AH3225	MM	100 - 300	0.5 - 1.5
			For wear resistance	AH8015			
P	Carbon steel, Alloy steel S55C, SCM440, etc. C55, 42CrMoS4, etc.	- 300HB	First choice	AH3225	MM	100 - 250	0.5 - 1.5
			For wear resistance	AH8015			
P	Prehardened steel NAK80, PX5, etc.	30 - 40HRC	First choice	AH3225	MM	100 - 200	0.5 - 1.2
			For wear resistance	AH8015			
M	Austenitic Stainless steel SUS304, SUS316, etc. X5CrNi18-9, X5CrNiMo17-12-2, etc.	- 200HB	First choice	AH3225	MM	80 - 150	0.5 - 1
			For wear resistance	AH8015			
M	Martensitic Stainless steel SUS410, SUS420J1, etc. X12Cr13, X20Cr13, etc.	- 200HB	First choice	AH3225	MM	50 - 120	0.3 - 1
			For wear resistance	AH8015			
K	Grey cast iron FC250, FC300, etc. 250, 300, etc.	150 - 250HB	First choice	AH8015	MM	100 - 300	0.5 - 1.5
			For impact resistance	AH3225			
K	Ductile cast iron FCD400, etc. 400-15, 600-3, etc.	150 - 250HB	First choice	AH8015	MM	80 - 200	0.5 - 1.5
			For impact resistance	AH3225			
S	Titanium alloy Ti-6Al-4V, etc.	- 40HRC	First choice	AH3225	MM	30 - 60	0.3 - 0.7
			For wear resistance	AH8015			
S	Superalloys Inconel718, etc.	- 40HRC	First choice	AH8015	MM	20 - 50	0.1 - 0.3
			For wear resistance	AH3225			
H	Hardened steel SKD61, etc. X40CrMoV5-1, etc.	40 - 50HRC	First choice	AH8015	MM	80 - 150	0.1 - 0.5
			For impact resistance	AH3225			
H	Hardened steel SKD11, etc. X153CrMoV12, etc.	50 - 60HRC	First choice	AH8015	MM	50 - 70	0.05 - 0.1
			For impact resistance	AH3225			

Approach angle

- 7°-25°
- 41°-45°
- 60°-70°
- 85°-88°
- 90°
- Others

APPLICATION RANGE

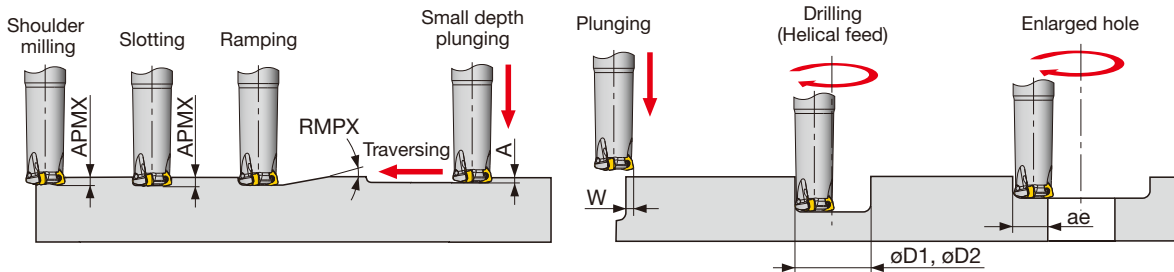

Designation	DCX	Max. depth of cut APMX	Max. ramping angle RMPX	Max. plunging depth A	Max. cutting width in plunging W	Min. machinable hole dia. øD1	Max. machinable hole dia. øD2	Max. cutting width in enlarged hole ae
E/HXWX03M016...	16	1	3	0.3	4	25	30	12
E/HXWX03M020...	20	1	2	0.3	4	31	38	16
E/HXWX03M025...	25	1	1.4	0.3	4	41	48	21
E/HXWX03M032...	32	1	1	0.3	4	54	62	28
TXWX03M040...	40	1	0.7	0.3	4	71	78	36
TXWX03M050...	50	1	0.6	0.3	4	87	98	46

Tool dia: DCX (mm), Number of revolution: n (min⁻¹), Feed speed: V_f (mm/min), Max. depth of cut: APMX = 1 mm, Number of teeth: CICT

ø16, CICT = 2		ø20, CICT = 3		ø25, CICT = 4		ø32, CICT = 5		ø40, CICT = 6		ø50, CICT = 8	
n	V_f	n	V_f	n	V_f	n	V_f	n	V_f	n	V_f
3,981	7,962	3,185	9,554	2,548	10,191	1,990	9,952	1,592	9,554	1,274	10,191
$V_c = 200$ m/min, $f_z = 1$ mm/t											
3,981	7,962	3,185	9,554	2,548	10,191	1,990	9,952	1,592	9,554	1,274	10,191
$V_c = 200$ m/min, $f_z = 1$ mm/t											
2,986	4,180	2,389	5,016	1,911	5,350	1,493	5,225	1,194	5,016	955	5,350
$V_c = 150$ m/min, $f_z = 0.7$ mm/t											
2,389	2,389	1,911	2,866	1,529	3,057	1,194	2,986	955	2,866	764	3,057
$V_c = 120$ m/min, $f_z = 0.5$ mm/t											
1,990	1,194	1,592	1,433	1,274	1,529	995	1,493	796	1,433	637	1,529
$V_c = 100$ m/min, $f_z = 0.3$ mm/t											
3,981	7,962	3,185	9,554	2,548	10,191	1,990	9,952	1,592	9,554	1,274	10,191
$V_c = 200$ m/min, $f_z = 1$ mm/t											
2,986	5,971	2,389	7,166	1,911	7,643	1,493	7,464	1,194	7,166	955	7,643
$V_c = 150$ m/min, $f_z = 1$ mm/t											
796	637	637	764	510	815	398	796	318	764	255	815
$V_c = 40$ m/min, $f_z = 0.4$ mm/t											
597	239	478	287	382	306	299	299	239	287	191	306
$V_c = 30$ m/min, $f_z = 0.2$ mm/t											
2,389	1,433	1,911	1,720	1,529	1,834	1,194	1,791	955	1,720	764	1,834
$V_c = 120$ m/min, $f_z = 0.3$ mm/t											
1,194	239	955	287	764	306	597	299	478	287	382	306
$V_c = 60$ m/min, $f_z = 0.1$ mm/t											

TOOL GEOMETRY ON PROGRAMMING

When programming for CAM, the tool should be considered as a radius cutter. Usually, the corner radius should be set as $R = 1.5$ mm. If a larger radius is used, overcutting will occur. The following table shows the amount left uncut (t_1) and overcut (t_2).

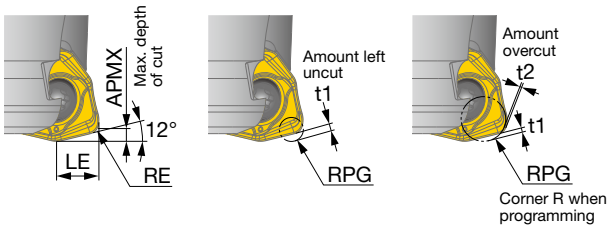

Max. depth of cut APMX (mm)	Corner radius RE (mm)	LE (mm)	Corner R when programming RPG	Amount left uncut t_1 (mm)	Amount overcut t_2 (mm)
1	1.2	3.5	1	0.56	-
1	1.2	3.5	1.5	0.46	-
1	1.2	3.5	2	0.35	0.16
1	1.2	3.5	2.5	0.2	0.5

*Recommended

Radius endmill, shank type cutter

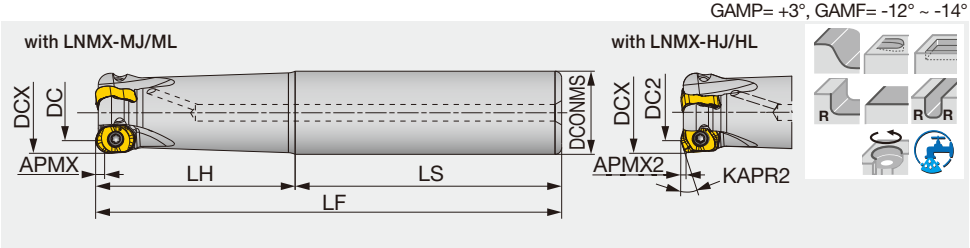

Designation	APMX	APMX2	DCX	CICT	DC	DC2	KAPR2	DCONMS	LS	LH	LF	WT(kg)	Air hole	Insert
EXLN04M020C20.0R02	4	1.3	20	2	12.2	11.6	20°	20	80	50	130	0.28	With	LNMX04...
EXLN04M020C20.0R02L	4	1.3	20	2	12.2	11.6	20°	20	80	80	160	0.34	With	LNMX04...
EXLN04M025C25.0R03	4	1.3	25	3	17.2	16.6	20°	25	80	60	140	0.46	With	LNMX04...
EXLN04M025C25.0R03L	4	1.3	25	3	17.2	16.6	20°	25	80	100	180	0.6	With	LNMX04...
EXLN05M025C25.0R02	5	-	25	2	15	-	-	25	90	60	150	0.54	With	LNMX05...
EXLN04M032C32.0R04	4	1.3	32	4	24.2	23.6	20°	32	80	70	150	0.83	With	LNMX04...
EXLN04M032C32.0R05	4	1.3	32	5	24.2	23.6	20°	32	80	70	150	0.83	With	LNMX04...
EXLN04M032C32.0R05L	4	1.3	32	5	24.2	23.6	20°	32	80	120	200	1.09	With	LNMX04...
EXLN05M032C32.0R04	5	-	32	4	21.9	-	-	32	80	70	150	0.87	With	LNMX05...
EXLN06M032C32.0R02	6	2	32	2	19.6	19.3	25°	32	80	70	150	0.9	With	LNMX06...
EXLN06M040C32.0R04	6	2	40	4	27.6	27.3	25°	32	100	50	150	0.95	With	LNMX06...

HXLN04-M

Radius endmill, modular type (TungFlex)

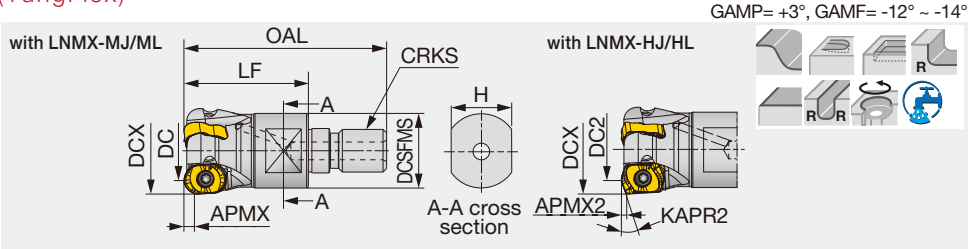

Designation	APMX	APMX2	DCX	CICT	DC	DC2	KAPR2	OAL	LF	H	DCSFMS	CRKS	WT(kg)	Air hole	Insert
HXLN04M020M10R02	4	1.3	20	2	12.2	11.6	20°	49	30	15	18	M10	0.07	With	LNMX04...
HXLN04M025M12R03	4	1.3	25	3	17.2	16.6	20°	57	35	17	21	M12	0.16	With	LNMX04...
HXLN05M025M12R02	5	-	25	2	15	-	-	57	35	17	21	M12	0.1	With	LNMX05...
HXLN04M032M16R04	4	1.3	32	4	24.2	23.6	20°	63	40	22	29	M16	0.2	With	LNMX04...
HXLN04M032M16R05	4	1.3	32	5	24.2	23.6	20°	63	40	22	29	M16	0.2	With	LNMX04...
HXLN05M032M16R04	5	-	32	4	21.9	-	-	63	40	22	28.8	M16	0.2	With	LNMX05...
HXLN06M032M16R02	6	2	32	2	19.6	19.3	25°	63	40	22	28.8	M16	0.24	With	LNMX06...
HXLN04M040M16R06	4	1.3	40	6	32.2	31.6	20°	63	40	22	29	M16	0.24	With	LNMX04...

SPARE PARTS

Designation	Clamping screw	Mono block wrench	Torx bit	Grip
EXLN04... / HXLN04...	CSPD-3	IP-10D	-	-
EXLN05... / HXLN05...	CSPB-4S	-	BLDIP15/S7	H-TB2W
EXLN06... / HXLN06...	CSPB-5	-	BLDIP20/S7	H-TB2W

Recommended clamping torque: CSPD-3 = 2.5 N·m, CSPB-4S = 3.5 N·m, CSPB-5 = 5 N·m

Reference pages: Standard cutting conditions → H048 - H049, TungFlex → H036 - H037

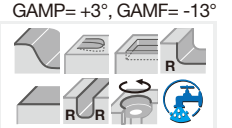
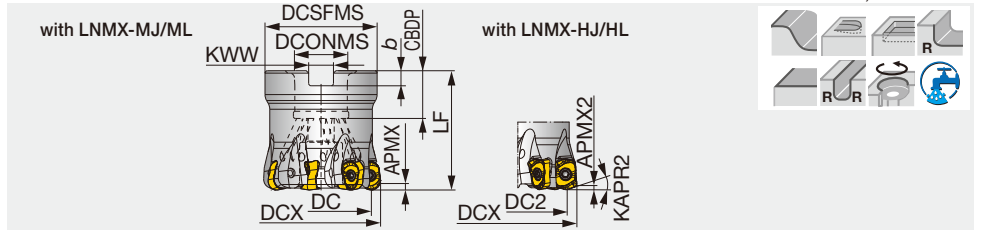

Designation	APMX	APMX2	DCX	CICT	DC	DC2	KAPR2	DCSFMS	LF	DCONMS	CBDP	KWW	b	WT(kg)	Air hole	Insert
TXLN04M040B16.0R06	4	1.3	40	6	32.2	31.6	20	35	40	16	18	8.4	5.6	0.21	With	LNMX04...
TXLN05M040B16.0R05	5	-	40	5	29.8	-	-	35	40	16	18	8.4	5.6	0.26	With	LNMX05...
TXLN04M042B16.0R06	4	1.3	42	6	34.2	33.6	20	35	40	16	18	8.4	5.6	0.21	With	LNMX04...
TXLN04M050B22.0R07	4	1.3	50	7	42.2	41.6	20	47	50	22	20	10.4	6.3	0.45	With	LNMX04...
TXLN05M050B22.0R06	5	-	50	6	39.8	-	-	47	50	22	20	10.4	6.3	0.5	With	LNMX05...
TXLN06M050B22.0R05	6	2	50	5	37.6	37.3	25	47	50	22	20	10.4	6.3	0.5	With	LNMX06...
TXLN04M052B22.0R07	4	1.3	52	7	44.2	43.6	20	47	50	22	20	10.4	6.3	0.47	With	LNMX04...
TXLN06M052B22.0R05	6	2	52	5	39.6	39.3	25	49	50	22	20	10.4	6.3	0.55	With	LNMX06...
TXLN04M063B22.0R07	4	1.3	63	7	55.2	54.6	20	59	50	22	20	10.4	6.3	0.76	With	LNMX04...
TXLN06M063B22.0R06	6	2	63	6	50.6	50.3	25	59	50	22	20	10.4	6.3	0.82	With	LNMX06...

SPARE PARTS

Designation	Clamping screw	Torx bit	Grip	Shell locking bolt
TXLN04M04*B16.0R06	CSPD-3	BLD IP10/S7	SW6-SD	FSHM8-30H
TXLN04M05*B22.0R07	CSPD-3	BLD IP10/S7	SW6-SD	CM10X30H
TXLN04M063B22.0R07	CSPD-3	BLD IP10/S7	SW6-SD	CM10X30H
TXLN05M040B16.0R05	CSPB-4S	BLDIP15/S7	H-TB2W	FSHM8-30H
TXLN05M050B22.0R06	CSPB-4S	BLDIP15/S7	H-TB2W	CM10X30H
TXLN06M050B22.0R05	CSPB-5	BLDIP20/S7	H-TB2W	FSHM10-40H
TXLN06M052... / TXLN06M063...	CSPB-5	BLDIP20/S7	H-TB2W	CM10X30H

Recommended clamping torque: CSPD-3 = 2.5 N·m, CSPB-4S = 3.5 N·m, CSPB-5 = 5 N·m

INSERT

LNMX-MJ (Radius, for general purpose)

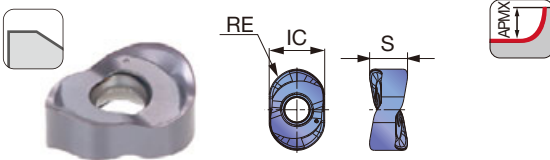

LNMX-ML (Radius, for low cutting force)

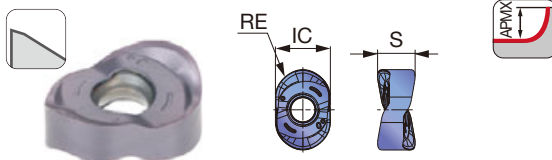

LNMX-HJ (High feed, for general purpose)

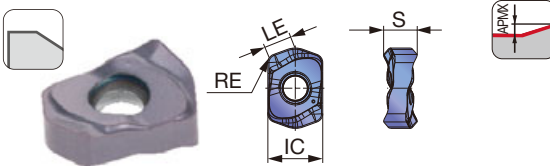

LNMX-HL (High feed, for low cutting force)

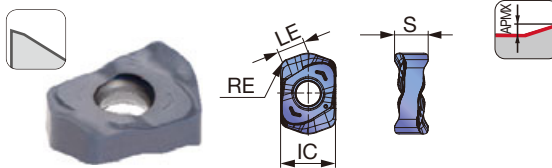

	P	M	K	N	S	H
Steel	☆	★	★	★		
Stainless		★	★	★		
Cast iron	★	☆	★	☆		
Non-ferrous						
Superalloys	★	☆	★	☆		
Hard materials	★	☆	☆	☆		

★ : First choice
☆ : Second choice

Designation	RE	APMX	Coated				LE	IC	S
			AH8015	AH3225	AH120	AH3135			
LNMX0405R4-MJ	4	4	●	●	●	●	-	8.2	5.6
LNMX0405R4-ML	4	4			●	●	-	8.2	5.6
LNMX0405ZER-HJ	1.3	1.3	●	●	●	●	4.3	8.2	5
LNMX0405ZER-HL	1.3	1.3	●	●		●	4.3	8.2	5
LNMX0506R5-MJ	5	5	●	●	●	●	-	10.4	6.1
LNMX0607R6-MJ	6	6	●	●	●	●	-	12.6	7.4
LNMX0607ZER-HJ	2	2	●	●	●	●	6.7	12.7	7.2

● : Line up

Reference pages: Standard cutting conditions → H048 - H049



STANDARD CUTTING CONDITIONS

FOR RADIUS (MJ, ML)



ISO	Workpiece material	Hardness	Priority	Grade	Chip-breaker	Cutting speed Vc (m/min)	Feed per tooth fz (mm/t)
P	Low carbon steel S15C, SS400, etc. C15, C20, etc.	- 200 HB	First choice	AH3225	MJ	100 - 300	0.2 - 0.6
			Low cutting force	AH3135	ML	100 - 300	0.2 - 0.6
			First choice	AH3225	MJ	100 - 250	0.2 - 0.6
	Carbon steel, Alloy steel S55C, SCM440, etc. C55, 42CrMoS4, etc.	- 300 HB	Low cutting force	AH3135	ML	100 - 250	0.2 - 0.6
			First choice	AH3225	MJ	100 - 200	0.15 - 0.4
			Low cutting force	AH3135	ML	100 - 200	0.15 - 0.4
M	Austenitic Stainless steel SUS304, SUS304, etc. X5CrNi18-9, X5CrNiMo17-12-2, etc.	- 200 HB	First choice	AH3135	MJ	100 - 200	0.2 - 0.6
			Low cutting force	AH3135	ML	100 - 200	0.2 - 0.6
			First choice	AH3135	ML	100 - 300	0.2 - 0.6
	Martensitic Stainless steel SUS410, SUS420J1, etc. X12Cr13, X20Cr13, etc.	- 200 HB	Fracture resistance	AH3135	MJ	100 - 300	0.2 - 0.6
			First choice	AH120	MJ	100 - 300	0.2 - 0.6
			Fracture resistance	AH3225	MJ	100 - 300	0.2 - 0.6
K	Grey cast iron FC250, FC300, etc. 250, 300, etc.	150 - 250 HB	First choice	AH120	MJ	80 - 250	0.2 - 0.6
			Fracture resistance	AH3225	MJ	80 - 250	0.2 - 0.6
			First choice	AH120	MJ	80 - 250	0.2 - 0.6
	Ductile cast iron FCD400, etc. 400-15, 600-3, etc.	150 - 250 HB	Fracture resistance	AH3225	MJ	80 - 250	0.2 - 0.6
			First choice	AH120	MJ	80 - 250	0.2 - 0.6
			Fracture resistance	AH3225	MJ	80 - 250	0.2 - 0.6
S	Titanium alloy Ti-6Al-4V, etc.	- 40 HRC	First choice	AH3135	ML	30 - 60	0.15 - 0.6
			Fracture resistance	AH3135	MJ	30 - 60	0.15 - 0.6
			First choice	AH8015	MJ	20 - 50	0.05 - 0.3
	Superalloys Inconel718, etc.	- 40 HRC	Low cutting force	AH120	ML	20 - 50	0.05 - 0.3
			First choice	AH3225	MJ	50 - 150	0.1 - 0.3
			Wear resistance	AH8015	MJ	50 - 150	0.1 - 0.3
H	Hardened steel SKD61, etc. X40CrMoV5-1, etc. SKD11, etc. X153CrMoV12, etc.	40 - 50 HRC	First choice	AH3225	MJ	50 - 150	0.1 - 0.3
			First choice	AH8015	MJ	50 - 70	0.05 - 0.15
			First choice	AH8015	MJ	50 - 70	0.05 - 0.15

· When using a long shank or modular head with long overhang, please lower the cutting conditions (Vc, fz, ap) to 70% of the maximum conditions for the standard shank.

HIGH FEED (HJ, HL)

LNMX04-HJ/HL

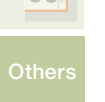
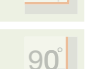
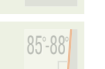

ISO	Workpiece material	Hardness	Priority	Grade	Chip-breaker	Cutting speed Vc (m/min)	Feed per tooth fz (mm/t)
P	Low carbon steel S15C, SS400, etc. C15, C20, etc.	- 300 HB	First choice	AH3225	HJ	100 - 300	0.5 - 1.3
			Wear resistance	AH8015	HJ		0.4 - 1
			Low cutting force	AH3225	HL		0.4 - 1
	Carbon steel, Alloy steel S55C, SCM440, etc. C55, 42CrMoS4, etc.	- 300 HB	First choice	AH3225	HJ	100 - 250	0.5 - 1.3
			Wear resistance	AH8015	HJ		0.4 - 1
			Low cutting force	AH3225	HL		0.4 - 1
	Prehardened steel NAK80, PX5, etc.	30 - 40 HRC	First choice	AH3225	HJ	100 - 200	0.4 - 1
			Wear resistance	AH8015	HJ		0.2 - 0.8
			Low cutting force	AH3225	HL		0.2 - 0.8
M	Austenitic Stainless steel SUS304, SUS304, etc. X5CrNi18-9, X5CrNiMo17-12-2, etc.	- 200 HB	First choice	AH3135	HL	100 - 200	0.3 - 0.9
			Fracture resistance	AH3135	HJ		0.3 - 0.9
			Fracture resistance	AH3135	HJ		0.3 - 0.9
K	Grey cast iron FC250, FC300, etc. 250, 300, etc.	150 - 250 HB	First choice	AH120	HJ	100 - 300	0.5 - 1.3
			Fracture resistance	AH3225	HJ		0.5 - 1.3
			Fracture resistance	AH3225	HJ		0.5 - 1.3
S	Titanium alloy Ti-6Al-4V, etc.	- 40 HRC	First choice	AH3135	HL	30 - 60	0.3 - 0.7
			Fracture resistance	AH3135	HJ		0.1 - 0.3
			Fracture resistance	AH3135	HJ		0.1 - 0.3
H	Hardened steel SKD61, etc. X40CrMoV5-1, etc. SKD11, etc. X153CrMoV12, etc.	40 - 50 HRC	First choice	AH3225	HJ	50 - 150	0.1 - 0.5
			Wear resistance	AH8015	HJ		0.05 - 0.2
			First choice	AH8015	HJ		0.05 - 0.2

HIGH FEED (HJ, HL)
LNMX06-HJ

ISO	Workpiece material	Hardness	Priority	Grade	Chip-breaker	Cutting speed Vc (m/min)	Feed per tooth fz (mm/t)
P	Low carbon steel S15C, SS400, etc. C15, C20, etc.	- 300HB	First choice	AH3225	HJ	100 - 300	0.3 - 1.1
			Wear resistance	AH8015			
	Carbon steel, Alloy steel S55C, SCM440, etc. C55, 42CrMoS4, etc.	- 300HB	First choice	AH3225	HJ	100 - 250	0.3 - 1.1
			Wear resistance	AH8015			
M	Prehardened steel NAK80, PX5, etc.	30 - 40HRC	First choice	AH3225	HJ	100 - 200	0.2 - 0.7
			Wear resistance	AH8015			
M	Austenitic Stainless steel SUS304, SUS304, etc. X5CrNi18-9, X5CrNiMo17-12-2, etc.	- 200HB	First choice	AH3135	HJ	100 - 200	0.2 - 0.7
			Wear resistance	AH8015			
K	Martensitic Stainless steel SUS410, SUS420J1, etc. X12Cr13, X20Cr13, etc.	- 200HB	First choice	AH3135	HJ	100 - 300	0.2 - 0.7
			Wear resistance	AH8015			
K	Grey cast iron FC250, FC300, etc. 250, 300, etc.	150 - 250HB	First choice	AH120	HJ	100 - 300	0.3 - 1.1
			Fracture resistance	AH3225			
K	Ductile cast iron FCD400, etc. 400-15, 600-3, etc.	150 - 250HB	First choice	AH120	HJ	80 - 250	0.3 - 1.1
			Fracture resistance	AH3225			
S	Titanium alloy Ti-6Al-4V, etc.	- 40 HRC	First choice	AH3135	HJ	30 - 60	0.15 - 0.6
			Wear resistance	AH8015			
H	Superalloys Inconel718, etc.	- 40 HRC	First choice	AH8015	HJ	20 - 50	0.05 - 0.3
			Wear resistance	AH3225			
H	Hardened steel	SKD61, etc. X40CrMoV5-1, etc.	First choice	AH3225	HJ	50 - 150	0.1 - 0.3
			Wear resistance	AH8015			
		SKD11, etc. X153CrMoV12, etc.	First choice	AH8015	HJ	50 - 70	0.05 - 0.15

· When using a long shank or modular head with long overhang, please lower the cutting conditions (Vc, fz, ap) to 70% of the maximum conditions for the standard shank.

Grade
Insert
Ext. Toolholder
Int. Toolholder
Threading
Grooving
Miniature tool
Milling cutter
Endmill
Drilling tool
Tooling System
User's Guide
Index





MACHINING APPLICATIONS

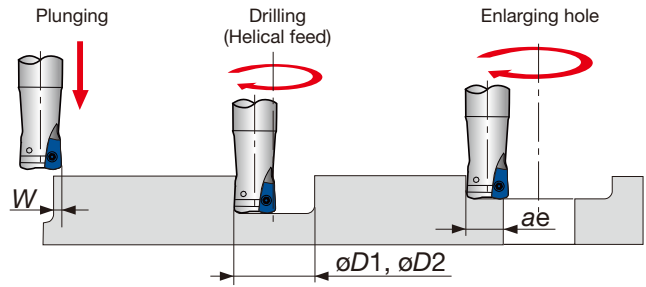
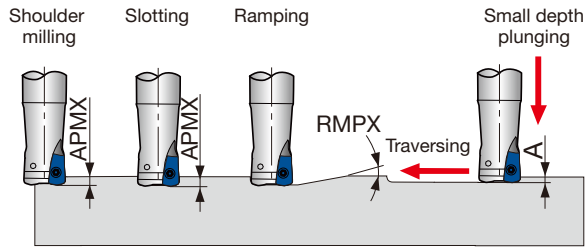
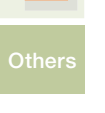
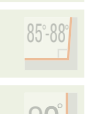
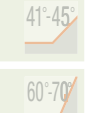

FOR RADIUS (MJ, ML)

Designation	DCX	Max. depth of cut APMX	Max. ramping angle RMPX	Max. plunging A	Max. cutting width in plunging W	Min. machining dia. øD1	Max. machining dia. øD2	Max. cutting width in enlarging ae
E/HXLN04M020...	20	4	4.5°	0.75	4	28	38	15
E/HXLN04M025...	25	4	2.9°	0.75	4	38	48	20
E/HXLN04M032...	32	4	1.9°	0.75	4	52	62	27
H/TXLN04M040...	40	4	1.2°	0.6	4	68	78	35
TXLN04M042B16.0R06	42	4	1.1°	0.6	4	72	82	37
TXLN04M050B22.0R07	50	4	0.9°	0.6	4	88	98	45
TXLN04M052B22.0R07	52	4	0.8°	0.6	4	92	102	47
TXLN04M063B22.0R07	63	4	0.7°	0.7	4	114	124	58
E/HXLN05M025...	25	5	2.3°	0.5	5	35	48	17
E/HXLN05M032...	32	5	2.1°	0.6	5	48	62	24
TXLN05M040B16.0R05	40	5	2°	1	5	64	78	31
TXLN05M050B22.0R06	50	5	1.3°	1	5	84	98	41
E/HXLN06M032...	32	6	3.7°	1	6	52	62	22
EXLN06M040C32.0R04	40	6	3.4°	1	6	60	78	29
TXLN06M050B22.0R05	50	6	2.8°	1.7	6	79	98	39
TXLN06M052B22.0R05	52	6	2.5°	1.6	6	81	102	41
TXLN06M063B22.0R06	63	6	1.8°	1.6	6	105	124	52

HIGH FEED (HJ, HL)

Designation	DCX	Max. depth of cut APMX	Max. ramping angle RMPX	Max. plunging A	Max. cutting width in plunging W	Min. machining øD1	Max. machining øD2	Max. cutting width in enlarging ae
E/HXLN04M020...	20	1.3	4.9°	0.7	4.1	27	38	15.5
E/HXLN04M025...	25	1.3	3°	0.7	4.1	37	48	20.5
E/HXLN04M032...	32	1.3	2°	0.7	4.1	51	62	27.5
E/TXLN04M040...	40	1.3	1.4°	0.7	4.1	67	78	35.5
TXLN04M042B16.0R06	42	1.3	1.3°	0.7	4.1	71	82	37.5
TXLN04M050B22.0R07	50	1.3	1°	0.7	4.1	87	98	45.5
TXLN04M052B22.0R07	52	1.3	0.9°	0.7	4.1	91	102	47.5
TXLN04M063B22.0R07	63	1.3	0.8°	0.7	4.1	113	124	58.5
E/HXLN06M032...	32	2	5.7°	1.4	6.1	42	62	20
EXLN06M040C32.0R04	40	2	3.8°	1.5	6.1	57	78	28
TXLN06M050B22.0R05	50	2	2.7°	1.6	6.1	77	98	38
TXLN06M052B22.0R05	52	2	2.5°	1.6	6.1	81	102	40
TXLN06M063B22.0R06	63	2	1.8°	1.5	6.1	104	124	51

TOOL GEOMETRY ON PROGRAMMING FOR HIGH FEED (HJ, HL)

The following table shows the amount left uncut (t1) and overcut (t2).

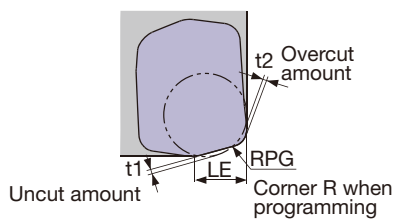

	Max. depth of cut APMX (mm)	LE (mm)	Programmed corner R (mm)	Amount left uncut t1 (mm)	Amount left overcut t2 (mm)
LNMX04-HJ LNMX04-HL	1.3	4.1	R1.5	0.8	-
	1.3	4.1	R2.0	0.65	-
	1.3	4.1	R2.5	0.5	0.05
LNMX06-HJ	1.3	4.1	R3.0	0.36	0.2
	2	6.1	R2.0	1.4	-
	2	6.1	R3.0	1.1	-
	2	6.1	R3.5	0.91	-
	2	6.1	R4.0	0.74	0.05
	2	6.1	R5.0	0.41	0.35

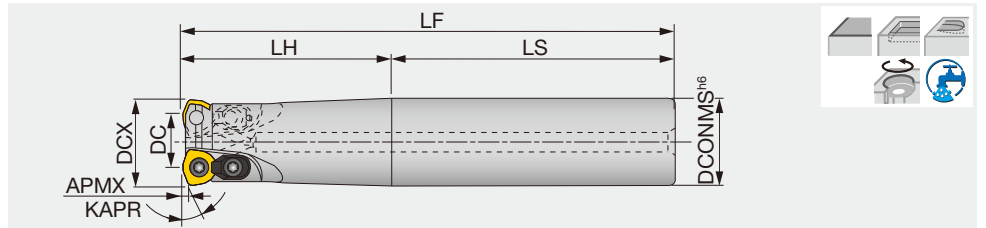

Designation	APMX	DCX	CICT	DC	DCONMS	LF	LH	LS	KAPR	Air hole	Insert	Shank
EXP05020RL	1.5	20	2	12.4	20	180	100	80	15°	with	WPM*05...	Cylindrical
EXP05020RLL	1.5	20	2	12.4	20	250	130	120	15°	with	WPM*05...	Cylindrical
EXP05020RS	1.5	20	2	12.4	20	130	50	80	15°	with	WPM*05...	Cylindrical
EXP05021RL	1.5	21	2	13.4	20	180	100	80	15°	with	WPM*05...	Cylindrical
EXP05021RLL	1.5	21	2	13.4	20	250	50	200	15°	with	WPM*05...	Cylindrical
EXP05021RS	1.5	21	2	13.4	20	130	50	80	15°	with	WPM*05...	Cylindrical
EXP06025RL	1.5	25	2	16.4	25	200	120	80	20°	with	WPM*06...	Cylindrical
EXP06025RLL	1.5	25	2	16.4	25	300	180	120	20°	with	WPM*06...	Cylindrical
EXP06025RS	1.5	25	2	16.4	25	140	60	80	20°	with	WPM*06...	Cylindrical
EXP06026RL	1.5	26	2	17.4	25	200	120	80	20°	with	WPM*06...	Cylindrical
EXP06026RLL	1.5	26	2	17.4	25	300	60	240	20°	with	WPM*06...	Cylindrical
EXP06026RS	1.5	26	2	17.4	25	140	60	80	20°	with	WPM*06...	Cylindrical
EXP06032RL	1.5	32	2	23.4	32	200	120	80	20°	with	WPM*06...	Cylindrical
EXP06032RLB	1.5	32	3	23.4	32	200	120	80	20°	with	WPM*06...	Cylindrical
EXP06032RLL	1.5	32	2	23.4	32	300	180	120	20°	with	WPM*06...	Cylindrical
EXP06032RS	1.5	32	2	23.4	32	150	70	80	20°	with	WPM*06...	Cylindrical
EXP06032RSB	1.5	32	3	23.4	32	150	70	80	20°	with	WPM*06...	Cylindrical
EXP06033RL	1.5	33	2	24.4	32	200	120	80	20°	with	WPM*06...	Cylindrical
EXP06033RLB	1.5	33	3	24.4	32	200	120	80	20°	with	WPM*06...	Cylindrical
EXP06033RLL	1.5	33	2	24.4	32	300	70	230	20°	with	WPM*06...	Cylindrical
EXP06033RS	1.5	33	2	24.4	32	150	70	80	20°	with	WPM*06...	Cylindrical
EXP06033RSB	1.5	33	3	24.4	32	150	70	80	20°	with	WPM*06...	Cylindrical
EXP06040RL	1.5	40	3	31.4	32	250	50	200	20°	with	WPM*06...	Cylindrical
EXP06040RLL	1.5	40	3	31.4	32	300	50	250	20°	with	WPM*06...	Cylindrical
EXP06040RLS42	1.5	40	3	31.4	42	250	50	200	20°	with	WPM*06...	Cylindrical
EXP06040RS	1.5	40	3	31.4	32	150	50	100	20°	with	WPM*06...	Cylindrical
EXP08040RLA	1.5	40	2	28.6	32	250	50	200	10°	with	WPMT08...	Cylindrical
EXP08040RLL	1.5	40	2	28.6	32	300	50	250	10°	with	WPMT08...	Cylindrical
EXP08040RSA	1.5	40	2	28.6	32	150	50	100	10°	with	WPMT08...	Cylindrical
EXP09050RS	3	50	2	36.4	42	150	50	100	20°	with	WPMT09...	Cylindrical
EXP09050RL	3	50	2	36.4	42	250	50	200	20°	with	WPMT09...	Cylindrical

SPARE PARTS



Designation	Clamp set	Clamping screw	Lubricant	Wrench 1	Wrench 2
EXP050...	-	CSPB-3.5S	M-1000	IP-15D	-
EXP060...	CSY-15	CSPB-4S	M-1000	IP-15D	-
EXP080...	CSX20	CSTB-5	M-1000	-	T-20T
EXP090...	CSY-20	CSPB-5	M-1000	-	IP-20T

Recommended clamping torque: CSPB-3.5S/CSPB-4S = 3.5 N·m, CSTB-5/CSPB-5 = 5 N·m





MILLFEED

TXP05/06/08/09

High feed bore type cutter with double clamp system

GAMP = +5°, GAMF = -4° - -6°

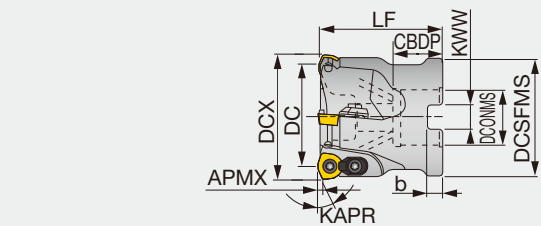

- High Feed Milling
- Face Milling
- Shoulder Milling
- Slot Milling
- Profile Milling
- Chamfering, Counterbore
- Finish Face Milling

- Approach angle
- 7°-25°
- 41°-45°
- 60°-70°
- 85°-88°
- 90°
- Others

Designation	APMX	DCX	CICT	DC	DCSFMS	LF	DCONMS	CBDP	KWW	b	KAPR	WT(kg)	Air hole	Insert
TXP06050R	1.5	50	4	41.4	47	50	22	20	10	6	20	0.4	without	WPM*06...
TXP06050R2	1.5	50	4	41.4	47	50	22.225	20	8	5	20	0.4	with	WPM*06...
TXP06050RA	1.5	50	4	41.4	47	50	22	20	10	6	20	0.4	with	WPM*06...
TXP08050R	1.5	50	3	38.6	47	50	22	19.5	10	6	10	0.4	with	WPMT08...
TXP08050R2	1.5	50	3	38.6	47	50	22.225	19.5	8	5	10	0.4	with	WPMT08...
TXP08050RA	1.5	50	3	38.6	47	50	22	19.5	10	6	10	0.4	with	WPMT08...
TXP08050R-E	1.5	50	3	38.6	47	50	22	20	10.4	6.3	10	0.4	without	WPMT08...
TXP08052R-E	1.5	52	3	40.6	50	50	22	20	10.4	6.3	10	0.5	without	WPMT08...
TXP05063RB-E	1.5	63	6	55.4	59	50	22	20	10.4	6.3	15	0.8	with	WPM*05...
TXP06063RB-E	1.5	63	5	54.4	59	50	22	20	10.4	6.3	20	0.7	with	WPM*06...
TXP08063R	1.5	63	4	51.6	59	50	22	20	10	6	10	0.7	with	WPMT08...
TXP08063R2	1.5	63	4	51.6	59	50	22.225	20	8	5	10	0.7	with	WPMT08...
TXP08063RA	1.5	63	4	51.6	59	50	22	20	10	6	10	0.7	with	WPMT08...
TXP08063R-E	1.5	63	4	51.6	59	50	22	20	10.4	6.3	10	0.7	without	WPMT08...
TXP09063R	3	63	3	49.4	59	50	22	20	10	6	20	0.6	with	WPMT09...
TXP09063R2	3	63	3	49.4	59	50	22.225	20	8	5	20	0.6	with	WPMT09...
TXP09063R-E	3	63	3	49.4	59	50	22	20	10.4	6.3	20	0.6	without	WPMT09...
TXP08066R-E	1.5	66	4	54.6	63	50	27	22	12.4	7	10	0.8	without	WPM*06...
TXP05080RB-E	1.5	80	7	72.4	76	63	27	22	12.4	7	15	1.7	with	WPM*05...
TXP06080RB-E	1.5	80	6	71.4	76	63	27	22	12.4	7	20	1.6	with	WPM*06...
TXP08080R	1.5	80	5	68.6	76	63	31.75	32	12.7	8	10	1.4	with	WPMT08...
TXP08080RA	1.5	80	5	68.6	76	63	31.75	32	12.7	8	10	1.4	with	WPMT08...
TXP08080R-E	1.5	80	5	68.6	76	63	27	22	12.4	7	10	1.5	without	WPM*06...
TXP09080R	3	80	4	66.4	76	63	31.75	32	12.7	8	20	1.3	with	WPMT09...
TXP09080R-E	3	80	4	66.4	76	63	27	22	12.4	7	20	1.3	without	WPMT09...
TXP08100R	1.5	100	6	88.6	96	63	31.75	32	12.7	8	10	2.5	with	WPMT08...
TXP08100RA	1.5	100	6	88.6	96	63	31.75	32	12.7	8	10	2.5	with	WPMT08...
TXP08100R-E	1.5	100	6	88.6	96	63	32	25	14.4	8	10	2.5	with	WPM*06...
TXP09100R	3	100	5	86.4	96	63	31.75	32	12.7	8	20	2.4	with	WPMT09...
TXP09100R-E	3	100	5	86.4	96	63	32	25	14.4	8	20	2.4	without	WPMT09...
TXP08125R	1.5	125	7	113.6	80	63	38.1	45	15.9	10	10	3.1	with	WPMT08...
TXP08125R-E	1.5	125	7	113.6	98	63	40	32	16.4	9	10	3.1	without	WPMT08...
TXP09125R	3	125	6	111.4	98	63	38.1	38	15.9	10	20	3.1	with	WPMT09...
TXP09125R-E	3	125	6	111.4	98	63	40	32	16.4	9	20	2.9	without	WPMT09...
TXP08160R	1.5	160	8	148.6	100	63	50.8	46	19	11	10	5.1	with	WPMT08...
TXP09160R	3	160	7	146.4	100	63	50.8	38	19	11	20	4.7	with	WPMT09...

SPARE PARTS



Designation	Clamp set	Clamping screw	Lubricant	Shell locking bolt 1	Shell locking bolt 2	Shell locking bolt 3	Wrench 1	Wrench 2
TXP05063RB-E	CSY-15	CSPB-3.5S	M-1000	-	CM10X30H	-	IP-15D	-
TXP05080RB-E	CSY-15	CSPB-3.5S	M-1000	-	-	CAP-CM12X1.75X30	IP-15D	-
TXP06050R	CSY-15	CSPB-4S	M-1000	-	-	CAP-CM10X1.5X30	IP-15D	-
TXP06050R2, RA	CSY-15	CSPB-4S	M-1000	-	CM10X30H	-	IP-15D	-
TXP06063RB-E	CSY-15	CSPB-4S	M-1000	-	CM12X30H	-	IP-15D	-
TXP08050R	CSX20	CSTB-5	M-1000	-	-	FSHM10-40	-	T-20T
TXP08050R-E	CSX20	CSTB-5	M-1000	-	FSHM10-40H	-	-	T-20T
TXP08063R	CSX20	CSTB-5	M-1000	-	-	CAP-CM10X1.5X30	-	T-20T
TXP08063R2	CSX20	CSTB-5	M-1000	-	CM10X30H	-	-	T-20T
TXP08063RA	CSX20	CSTB-5	M-1000	-	-	-	-	T-20T
TXP08063, 066R-E	CSX20	CSTB-5	M-1000	-	-	-	-	T-20T
TXP08080R	CSX20	CSTB-5	M-1000	-	-	CAP-CM16X2.0X40	-	T-20T
TXP08100R	CSX20	CSTB-5	M-1000	-	-	-	-	T-20T
TXP08080RA	CSX20	CSTB-5	M-1000	-	CM16X40H	-	-	T-20T
TXP08100RA	CSX20	CSTB-5	M-1000	-	-	-	-	T-20T
TXP08080R-E	CSX20	CSTB-5	M-1000	-	-	-	-	T-20T
TXP08100R-E	CSX20	CSTB-5	M-1000	-	-	-	-	T-20T
TXP08125R	CSX20	CSTB-5	M-1000	TMBA-M20H	-	-	-	T-20T
TXP08160R	CSX20	CSTB-5	M-1000	TMBA-M24H	-	-	-	T-20T
TXP09063R*	CSY-20	CSPB-5	M-1000	-	CM10X30H	-	-	IP-20T
TXP09063R-E	CSY-20	CSPB-5	M-1000	-	-	-	-	IP-20T
TXP09080R-E	CSY-20	CSPB-5	M-1000	-	-	-	-	IP-20T
TXP09100R-E	CSY-20	CSPB-5	M-1000	-	-	-	-	IP-20T
TXP09125R-E	CSY-20	CSPB-5	M-1000	-	-	-	-	IP-20T
TXP09080R	CSY-20	CSPB-5	M-1000	-	CM16X40H	-	-	IP-20T
TXP09100R	CSY-20	CSPB-5	M-1000	-	-	-	-	IP-20T
TXP09125R	CSY-20	CSPB-5	M-1000	TMBA-M20H	-	-	-	IP-20T
TXP09160R	CSY-20	CSPB-5	M-1000	TMBA-M24H	-	-	-	IP-20T

Recommended clamping torque: CSPB-3.5S/CSPB-4S = 3.5 N·m, CSTB-5/CSPB-5 = 5 N·m

Reference pages: Inserts → H053, Standard cutting conditions → H054 - H055

INSERT

WPMW05/06

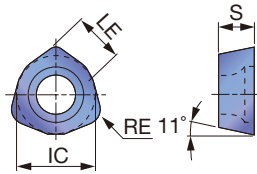

WPMT08/09

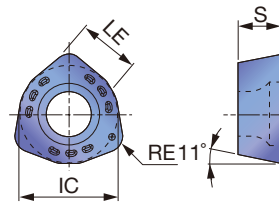

WPMT05/06/08/09-ML

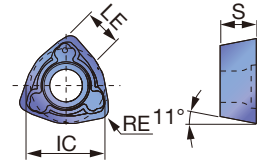

WPMT05/06/08/09-MH

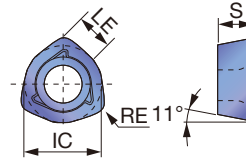

WPMT05/06/08/09-DML

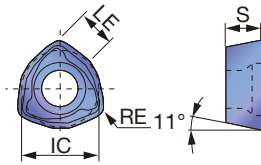

P	Steel	☆				☆	★													
M	Stainless		★	☆			★													
K	Cast iron	★																		
N	Non-ferrous																			
S	Superalloys	★	☆																	
H	Hard materials				★															

★ : First choice
☆ : Second choice

Designation	RE	APMX	Coated						LE	IC	S
			AH120	AH130	AH140	AH730	T3130	AH3135			
WPMW05H315ZPR	1.5	1.5	●	●	●	●			5	7.94	3.5
WPMT05H315ZPR-ML	1.5	1.5	●	●	●	●			5	7.94	3.5
WPMT05H315ZPR-MH	1.5	1.5	●	●	●	●			5	7.94	3.5
WPMT05H315ZPR-DML	1.5	1.5				●			5	7.94	3.5
WPMW06X415ZPR	1.5	1.5	●	●	●	●			6	9.525	4.2
WPMT06X415ZPR-ML	1.5	1.5	●	●	●	●			6	9.525	4.2
WPMT06X415ZPR-MH	1.5	1.5	●	●	●	●			6	9.525	4.2
WPMT06X415ZPR-DML	1.5	1.5				●			6	9.525	4.2
WPMT080615ZSR	1.5	1.5	●	●	●	●	●		8	12.87	6.35
WPMT080615ZPR-ML	1.5	1.5	●	●	●	●	●		8	12.87	6.35
WPMT080615ZSR-MH	1.5	1.5	●	●	●	●	●		8	12.87	6.35
WPMT080615ZPR-DML	1.5	1.5				●			8	12.87	6.35
WPMT090725ZSR	2.5	3	●	●	●	●	●		9	15	7
WPMT090725ZPR-ML	2.5	3	●	●	●	●	●		9	15	7
WPMT090725ZSR-MH	2.5	3	●	●	●	●	●		9	15	7
WPMT090725ZPR-DML	2.5	3				●			9	15	7

● : Line up

Reference pages: Standard cutting conditions → **H054 - H055**



High Feed Milling

STANDARD CUTTING CONDITIONS

05-06 type

ISO	Workpiece material	Hardness	Grade	Cutting speed Vc (m/min)	Feed per tooth fz (mm/t)	ø20, 21 (CICT = 2)	ø25, 26 (CICT = 2)	ø32, 33 (CICT = 2, 3)	ø40 (CICT = 3)	ø50 (CICT = 4)	ø63 (CICT = 5, 6)
P	Carbon Steels S50C, etc. C50, etc.	< 300HB	AH3135	100 - 250	0.5 - 2	Vc = 150 m/min, fz = 0.8 mm/t ap = 1 mm, ae = 1×DCX mm	Vc = 150 m/min, fz = 1 mm/t ap = 1 mm, ae = 1×DCX mm				
	When plunging in small depth: fz = 0.2 mm/t										
	Alloy steels SCM440, etc. 42CrMo4etc, etc.	< 300HB	AH3135	100 - 200	0.5 - 2	Vc = 130 m/min, fz = 0.8 mm/t ap = 1 mm, ae = 1×DCX mm	Vc = 130 m/min, fz = 1 mm/t ap = 1 mm, ae = 1×DCX mm				
When plunging in small depth: fz = 0.2 mm/t											
M	Prehardened steels NAK80, PX5, X96CrMoV12, etc.	30 - 40HRC	AH3135	80 - 150	0.5 - 1	Vc = 100 m/min, fz = 0.5 mm/t ap = 1 mm, ae = 1×DCX mm	Vc = 100 m/min, fz = 0.5 mm/t ap = 1 mm, ae = 1×DCX mm				
	When plunging in small depth: fz = 0.1 mm/t										
	Stainless steels SUS304, etc. X5CrNi18 9, etc.	- 200HB	AH130 (AH3135)	100 - 200	0.5 - 2	Vc = 130 m/min, fz = 0.8 mm/t ap = 1 mm, ae = 1×DCX mm	Vc = 130 m/min, fz = 1 mm/t ap = 1 mm, ae = 1×DCX mm				
When plunging in small depth: fz = 0.2 mm/t											
K	Cast irons FC250, etc. 250, etc.	150 - 250HB	AH120	100 - 250	0.8 - 2.5	Vc = 150 m/min, fz = 1 mm/t ap = 1 mm, ae = 1×DCX mm	Vc = 180 m/min, fz = 1.5 mm/t ap = 1 mm, ae = 1×DCX mm				
	When plunging in small depth: fz = 0.2 mm/t										
	Titanium alloys Ti-6Al-4V, etc.	- 40HRC	AH130	30 - 60	0.3 - 0.7	Vc = 50 m/min, fz = 0.5 mm/t, ap = 0.7 mm, ae = 0.5×DCX mm					
When plunging in small depth: fz = 0.1 mm/t											
S	Heat-resistant alloys Inconel 718, etc.	- 40HRC	AH120	10 - 40	0.1 - 0.3	Vc = 30 m/min, fz = 0.2 mm/t, ap = 0.7 mm, ae = 0.5×DCX mm					
	When plunging in small depth: fz = 0.1 mm/t										
	Hard materials SKD11, etc. X153CrMoV12, etc.	40 - 50HRC	AH730	50 - 80	0.5 - 1	Vc = 70 m/min, fz = 0.7 mm/t, ap = 0.7 mm, ae = 1×DCX mm					
When plunging in small depth: fz = 0.1 mm/t											

08 type

ISO	Workpiece material	Hardness	Grade	Cutting speed Vc (m/min)	Feed per tooth fz (mm/t)	ø40 (CICT = 2)	ø50 (CICT = 3)	ø63 (CICT = 4)	ø80 (CICT = 5)	ø100 (CICT = 6)	ø125 (CICT = 7)	ø160 (CICT = 8)
P	Carbon Steels S50C, etc. C50, etc.	< 300HB	AH3135	100 - 250	0.5 - 2	Vc = 180 m/min, fz = 1 mm/t ap = 1 mm, ae = 40 mm	Vc = 200 m/min, fz = 1.5 mm/t ap = 1 mm, ae = 1×DCX mm					
	When plunging in small depth: fz = 0.2 mm/t											
	Alloy steels SCM440, etc. 42CrMo4etc, etc.	< 300HB	AH3135	100 - 200	0.5 - 2	Vc = 130 m/min, fz = 1 mm/t ap = 1 mm, ae = 40 mm	Vc = 150 m/min, fz = 1.5 mm/t ap = 1 mm, ae = 1×DCX mm					
When plunging in small depth: fz = 0.2 mm/t												
M	Prehardened steels NAK80, PX5, X96CrMoV12, etc.	30 - 40HRC	AH3135	80 - 150	0.5 - 1	Vc = 100 m/min, fz = 0.5 mm/t ap = 1 mm, ae = 40 mm	Vc = 120 m/min, fz = 0.8 mm/t ap = 1 mm, ae = 1×DCX mm					
	When plunging in small depth: fz = 0.1 mm/t											
	Stainless steels SUS304, etc. X5CrNi18 9, etc.	- 200HB	AH130 (AH3135)	100 - 200	0.5 - 2	Vc = 130 m/min, fz = 1 mm/t ap = 1 mm, ae = 40 mm	Vc = 150 m/min, fz = 1.5 mm/t ap = 1 mm, ae = 1×DCX mm					
When plunging in small depth: fz = 0.2 mm/t												
K	Cast irons FC250, etc. 250, etc.	150 - 250HB	AH120	150 - 250	0.8 - 2.5	Vc = 180 m/min, fz = 1.5 mm/t ap = 1 mm, ae = 40 mm	Vc = 200 m/min, fz = 2 mm/t ap = 1 mm, ae = 1×DCX mm					
	When plunging in small depth: fz = 0.2 mm/t											
	Titanium alloys Ti-6Al-4V, etc.	- 40HRC	AH130	30 - 60	0.3 - 0.7	Vc = 50 m/min, fz = 0.5 mm/t, ap = 0.7 mm, ae = 0.5×DCX mm						
When plunging in small depth: fz = 0.1 mm/t												
S	Heat-resistant alloys Inconel 718, etc.	- 40HRC	AH120	10 - 40	0.1 - 0.3	Vc = 30 m/min, fz = 0.2 mm/t, ap = 0.7 mm, ae = 0.5×DCX mm						
	When plunging in small depth: fz = 0.1 mm/t											
	Hard materials SKD11, etc. X153CrMoV12, etc.	40 - 50HRC	AH730	50 - 80	0.5 - 1	Vc = 70 m/min, fz = 0.7 mm/t, ap = 0.7 mm, ae = 1×DCX mm						
When plunging in small depth: fz = 0.1 mm/t												

Note: •The above values of cutting speed show the standard speed when overhang length of tool is below 3D. The cutting speed and the feed rate should be set at the lower limit values when overhang length of tool exceeds 3D.
 •Thick and heavy chips are discharged by these TAC mills. Use internal air supply or air-blowing in order to prevent tool failure.

Approach angle

7°-25°

41°-45°

60°-70°

85°-88°

90°

Others

STANDARD CUTTING CONDITIONS

09 type

ISO	Workpiece material	Hardness	Grade	Cutting speed Vc (m/min)	Feed per tooth fz (mm/t)	ø50 (CICT = 2)	ø63 (CICT = 3)	ø80 (CICT = 4)	ø100 (CICT = 5)	ø125 (CICT = 6)	ø160 (CICT = 7)
P	Carbon Steels S50C, etc. C50, etc.	< 300HB	AH3135	100 - 250	0.5 - 2	Vc = 200 m/min, fz = 1.5 mm/t, ap = 2 mm, ae = 1×DCX mm					
						When plunging in small depth: fz = 0.2 mm/t					
P	Alloy steels SCM440, etc. 42CrMo4etc, etc.	< 300HB	AH3135	100 - 200	0.5 - 2	Vc = 150 m/min, fz = 1.5 mm/t, ap = 2 mm, ae = 1×DCX mm					
						When plunging in small depth: fz = 0.2 mm/t					
P	Prehardened steels NAK80, PX5, X96CrMoV12, etc.	30 - 40HRC	AH3135	80 - 150	0.5 - 1	Vc = 120 m/min, fz = 0.8 mm/t, ap = 2 mm, ae = 1×DCX mm					
						When plunging in small depth: fz = 0.1 mm/t					
M	Stainless steels SUS304, etc. X5CrNi18 9, etc.	- 200HB	AH130 (AH3135)	100 - 200	0.5 - 2	Vc = 150 m/min, fz = 1.5 mm/t, ap = 2 mm, ae = 1×DCX mm					
						When plunging in small depth: fz = 0.2 mm/t					
K	Cast irons FC250, etc. 250, etc.	150 - 250HB	AH120	150 - 250	0.8 - 2.5	Vc = 200 m/min, fz = 2 mm/t, ap = 2 mm, ae = 1×DCX mm					
						When plunging in small depth: fz = 0.2 mm/t					
S	Titanium alloys Ti-6Al-4V, etc.	- 40HRC	AH130	30 - 60	0.3 - 0.7	Vc = 50 m/min, fz = 0.5 mm/t, ap = 1.5 mm, ae = 0.5×DCX mm					
						When plunging in small depth: fz = 0.1 mm/t					
S	Heat-resistant alloys Inconel 718, etc.	- 40HRC	AH120	10 - 40	0.1 - 0.3	Vc = 30 m/min, fz = 0.2 mm/t, ap = 1 mm, ae = 0.5×DCX mm					
						When plunging in small depth: fz = 0.1 mm/t					
H	Hard materials SKD11, etc. X153CrMoV12, etc.	40 - 50HRC	AH730	60 - 100	0.5 - 1	Vc = 70 m/min, fz = 0.7 mm/t, ap = 0.7 mm, ae = 1×DCX mm					
						When plunging in small depth: fz = 0.1 mm/t					

Notes : The cutting speed and feed should be set to 70 to 80 % of the value shown in the above table when overhang length of tool exceeds 3D.

MILLFEED

BT50-FMC/FMA

Arbor

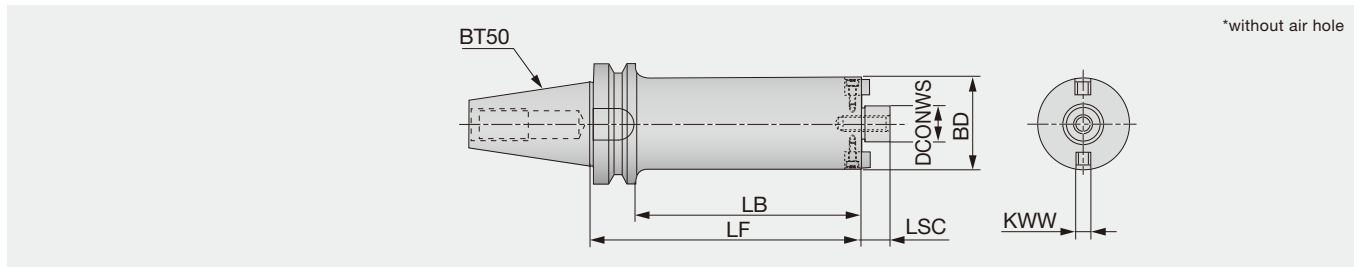

Designation	LF	LB	BD	DCONWS	LSC	KWW	WT(kg)
BT50-FMC22-138-47	138	100	47	22	18	10	5.2
BT50-FMC22-188-47	188	150	47	22	18	10	5.9
BT50-FMC22-243-47	243	205	47	22	18	10	6.5
BT50-FMC22-293-47	293	255	47	22	18	10	7.2
BT50-FMC22-178-59	178	140	59	22	18	10	6.8
BT50-FMC22-238-59	238	200	59	22	18	10	8
BT50-FMC22-308-59	308	270	59	22	18	10	9.5
BT50-FMC22-373-59	373	335	59	22	18	10	10.9
BT50-FMA31.75-215-76	215	177	76	31.75	30	12.7	10
BT50-FMA31.75-295-76	295	257	76	31.75	30	12.7	12.9
BT50-FMA31.75-375-76	375	337	76	31.75	30	12.7	15.8
BT50-FMA31.75-275-96	275	237	96	31.75	30	12.7	16.8
BT50-FMA31.75-375-96	375	337	96	31.75	30	12.7	23

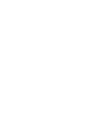

APPLICATION RANGE

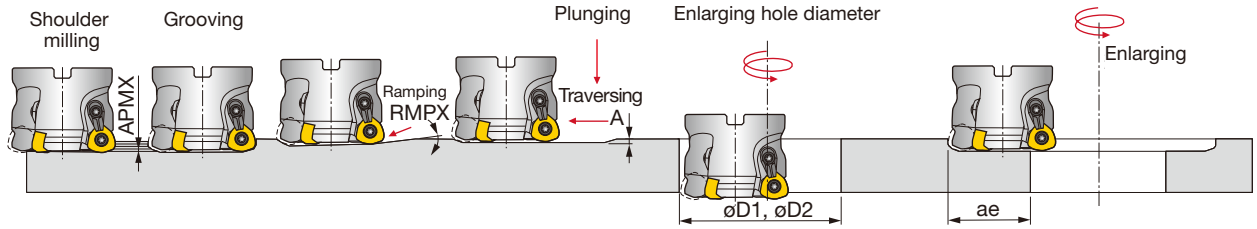

Designation	DCX	Max. depth of cut APMX	Max. ramping angle RMPX	Max. plunging depth A	Min. machining hole dia. øD1	Max. machining hole dia. øD2	Max. cutting width in enlarging hole ae
EXP05020...	20	1.5	3°	0.5	30	37	16
EXP05021...	21	1.5	2.5°	0.5	32	39	17
TXP05063RB-E	63	1.5	1°	0.5	116	123	59
TXP05080RB-E	80	1.5	0.5	0.5	150	157	76
E/HXP06025...	25	1.5	5°	1	33	47	20
E/HXP06026...	26	1.5	4.5°	1	35	49	21
E/HXP06032...	32	1.5	3.5°	1	47	61	27
E/HXP06033...	33	1.5	3°	1	49	63	28
E/HXP06040...	40	1.5	2°	1	63	77	35
T/HXP06050...	50	1.5	1.5°	1	83	97	45
TXP06063RB-E	63	1.5	1°	1	109	123	58
TXP06080RB-E	80	1.5	0.5	1	143	157	75
E/HXP08040...	40	1.5	6°	1	53	77	34
T/HXP08050...	50	1.5	4°	1	72	97	44
TXP08052R-E	52	1.5	4°	1	76	101	46
TXP08063...	63	1.5	2.5°	1	98	123	57
TXP08066R-E	66	1.5	2.5	1	104	129	60
TXP08080...	80	1.5	1.5°	1	132	157	74
TXP08100...	100	1.5	1°	1	172	197	94
TXP08125R	125	1.5	0.75°	1	222	247	119
TXP08160R	160	1.5	0.5°	1	292	317	154
E/HXP09050...	50	3	1.5°	0.8	76	97	43
EXP09050RS/L	50	3	1.5	0.8	76	97	43
TXP09063...	63	3	2°	1.5	98	123	56
TXP09080R	80	3	1.5°	1.5	132	157	73
TXP09100R	100	3	1°	1.5	172	197	93
TXP09125R	125	3	0.75°	1.5	222	247	118
TXP09160R	160	3	0.5°	1.5	292	317	153

TOOL GEOMETRY FOR PROGRAMMING

When programming for CAD/CAM, the tool should be assumed to be a radius cutter shown in the table below. In this case, the amount left as uncut (t) is shown below.

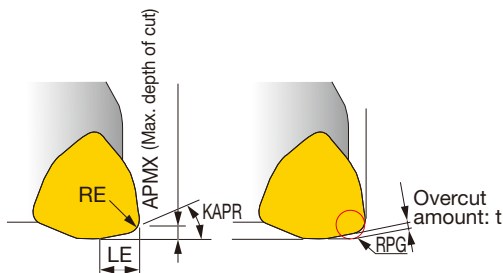

	Max. depth of cut	Corner of insert	Cutting edge angle	Corner R when programming	t	RPG
TXP	APMX	RE	KAPR	LE	t	RPG
05	1.5	1.5	15°	3.8	0.5	2
06	1.5	1.5	20°	4.3	0.7	2.5
08	1.5	1.5	10°	5.7	0.7	2
09	3	2.5	20°	6.8	1.4	3
09	3	2.5	20°	6.8	1.2	4

High feed mill

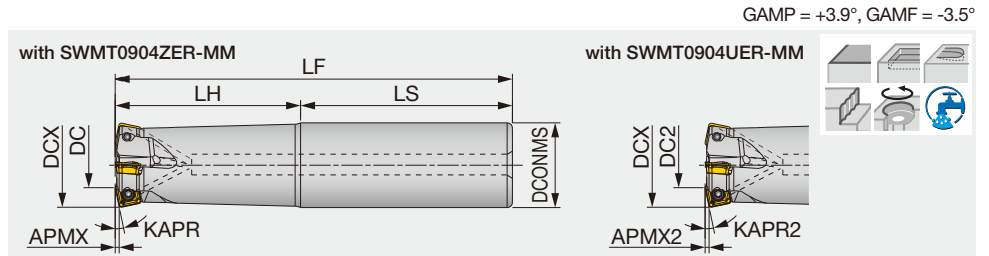

Designation	APMX	APMX2	DCX	CICT	DC	DC2	DCONMS	LF	LH	LS	KAPR	KAPR2	WT(kg)	Air hole	Insert
EXSW09M025C25.0R03	1.5	1	25	3	10	9	25	140	60	80	12°	7°	0.45	With	SWMT09...
EXSW09M025C25.0R03L	1.5	1	25	3	10	9	25	180	100	80	12°	7°	0.57	With	SWMT09...
EXSW09M032C32.0R04	1.5	1	32	4	17	16	32	150	70	80	12°	7°	0.81	With	SWMT09...
EXSW09M032C32.0R04L	1.5	1	32	4	17	16	32	200	120	80	12°	7°	1.07	With	SWMT09...

HXSW09

High feed mill, modular type (TungFlex), for 4-corner single sided inserts

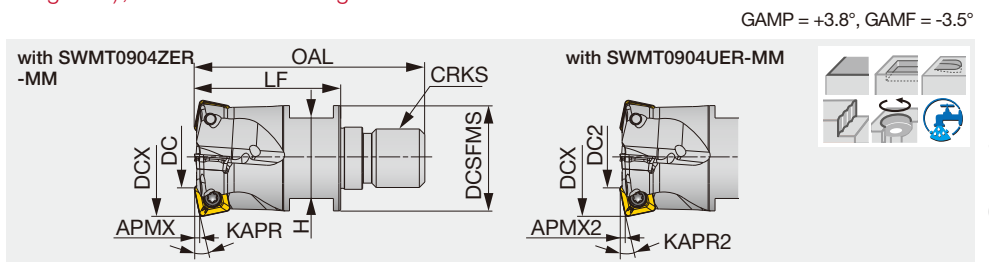

Designation	APMX	APMX2	DCX	CICT	DC	DC2	OAL	LF	H	DCSFMS	KAPR	KAPR2	CRKS	WT (kg)	Air hole	Insert
HXSW09M025M12R03	1.5	1	25	3	10	9	57	35	17	20.8	12°	7°	M12	0.09	With	SWMT09...
HXSW09M032M16R04	1.5	1	32	4	17	16	63	40	22	28.8	12°	7°	M16	0.18	With	SWMT09...

SPARE PARTS

Designation	Clamping screw	Mono block wrench	Lubricant
EXSW09... / HXSW09...	CSPD-3	IP-10D	M-1000

Recommended clamping torque: 2.5 N·m



High feed mill

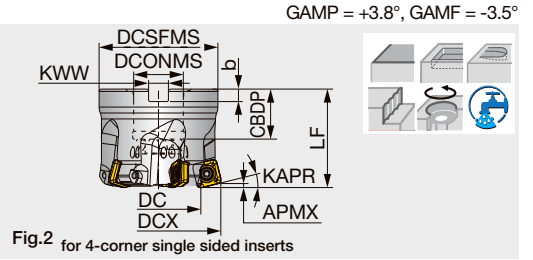
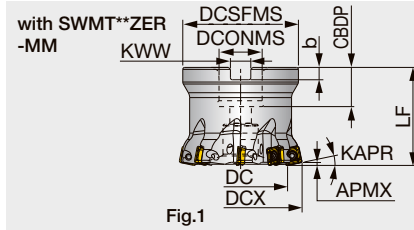

Designation	APMX	APMX2	DCX	CICT	DC	DC2	DCSFMS	DCONMS	CBDP	LF	KWW	b	KAPR	KAPR2	WT(kg)	Air hole	Insert	Fig.
TXSW09M040B16.0R04	1.5	1	40	4	25	24	38	16	18	40	8.4	5.6	12°	7°	0.2	With	SWMT09...	1
TXSW09M040B16.0R05	1.5	1	40	5	25	24	38	16	18	40	8.4	5.6	12°	7°	0.2	With	SWMT09...	1
TXSW09M050B22.0R05	1.5	1	50	5	35	34	47	22	20	50	10.4	6.3	12°	7°	0.37	With	SWMT09...	1
TXSW09M050B22.0R07	1.5	1	50	7	35	34	47	22	20	50	10.4	6.3	12°	7°	0.38	With	SWMT09...	1
TXSW15M050B22.0R03	2.5	2	50	3	24.1	22.2	47	22	20	50	10.4	6.3	14°	10°	0.4	With	SWMT15...	2
TXSW09M052B22.0R05	1.5	1	52	5	37	36	49	22	20	50	10.4	6.3	12°	7°	0.42	With	SWMT09...	1
TXSW09M052B22.0R07	1.5	1	52	7	37	36	49	22	20	50	10.4	6.3	12°	7°	0.38	With	SWMT09...	1
TXSW09M063B22.0R06	1.5	1	63	6	48	47	59	22	20	50	10.4	6.3	12°	7°	0.69	With	SWMT09...	1
TXSW09M063B22.0R08	1.5	1	63	8	48	47	59	22	20	50	10.4	6.3	12°	7°	0.7	With	SWMT09...	1
TXSW15M063B22.0R04	2.5	2	63	4	37.1	35.2	59	22	20	50	10.4	6.3	14°	10°	0.66	With	SWMT15...	2
TXSW15J080B31.7R05	2.5	2	80	5	54.1	52.2	76	31.75	32	63	12.7	8	14°	10°	1.31	With	SWMT15...	2
TXSW15M080B27.0R05	2.5	2	80	5	54.1	52.2	76	27	22	63	12.4	7	14°	10°	1.41	With	SWMT15...	2
TXSW15J100B31.7R06	2.5	2	100	6	74.1	72.2	96	31.75	32	63	12.7	8	14°	10°	2.25	With	SWMT15...	2
TXSW15M100B32.0R06	2.5	2	100	6	74.1	72.2	96	32	25	63	14.4	8	14°	10°	2.26	With	SWMT15...	2
TXSW15J125B38.1R07	2.5	2	125	7	99.1	97.2	100	38.1	43	63	15.9	10	14°	10°	2.91	With	SWMT15...	2
TXSW15M125B40.0R07	2.5	2	125	7	99.1	97.2	100	40	37	63	16.4	9	14°	10°	2.83	With	SWMT15...	2
TXSW15J160B50.8R08	2.5	2	160	8	134.1	132.2	100	50.8	46	63	19	11	14°	10°	3.93	With	SWMT15...	2
TXSW15M160B40.0R08	2.5	2	160	8	134.1	132.2	100	40	37	63	16.4	9	14°	10°	4.23	With	SWMT15...	2

SPARE PARTS

Designation	Clamping screw	Grip	Lubricant	Shell locking bolt 1	Shell locking bolt 2	Shell locking bolt 3	Torx bit
TXSW09M04...	CSPD-3	H-TB2W	M-1000	-	FSHM8-30H	-	BLDIP10/S7
TXSW09M05...	CSPD-3	H-TB2W	M-1000	-	FSHM10-40H	-	BLDIP10/S7
TXSW09M06...	CSPD-3	H-TB2W	M-1000	-	CM10X30H	-	BLDIP10/S7
TXSW15M050B22.0R03	TS50115I	H-TB2W	M-1000	-	-	SRPS118-0273	BT20S
TXSW15M063B22.0R04	TS50115I	H-TB2W	M-1000	-	FSHM10-40H	-	BT20S
TXSW15J080B31.7R05	TS50115I	H-TB2W	M-1000	-	CM16X40H	-	BT20S
TXSW15M080B27.0R05	TS50115I	H-TB2W	M-1000	-	CM12X30H	-	BT20S
TXSW15*100B...	TS50115I	H-TB2W	M-1000	-	CM16X40H	-	BT20S
TXSW15*125B...	TS50115I	H-TB2W	M-1000	TMBA-M20H	-	-	BT20M
TXSW15J160B50.8R08	TS50115I	H-TB2W	M-1000	TMBA-M24H	-	-	BT20M
TXSW15M160B40.0R08	TS50115I	H-TB2W	M-1000	TMBA-M20H	-	-	BT20M

Recommended clamping torque: CSPD-3 = 2.5 N·m, TS50115I = 5 N·m

Reference pages: Inserts → H059, Standard cutting conditions → H060 - H061, TungFlex → H036 - H037

INSERT

SWMT09/15ZER-MM (for general purpose)

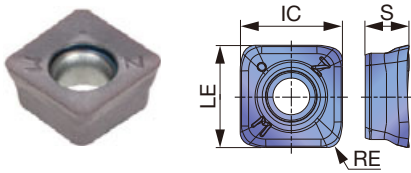

SWMT09/15UER-MM (for general purpose)

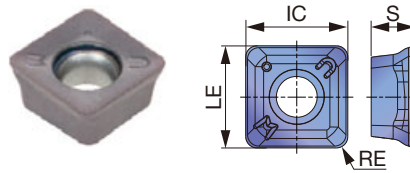

SWMT15ZER-MT (Robust cutting edges)

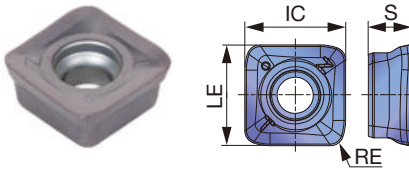

P	Steel		☆	★		
M	Stainless	★	☆	☆		
K	Cast iron		☆	☆	★	
N	Non-ferrous					
S	Titanium	★	☆			
S	Heat resistant alloy				☆	★
H	Hard materials		☆	☆	★	

★ : First choice
☆ : Second choice

Designation	RE	APMX	Coated					LE	IC	S
			AH130	AH3135	AH3225	AH120	AH8015			
SWMT0904ZER-MM	1	1.5	●	●	●	●	●	8.605	8.605	4
SWMT0904UER-MM	1	1	●	●	●	●	●	9.05	9.05	4
SWMT1506ZER-MM	2	2.5		●		●		16.01	16.01	6.8
SWMT1506UER-MM	2	2		●				16.27	16.27	6.8
SWMT1506ZER-MT	2	2.5		●		●		15.925	15.925	6.8

● : Line up





High Feed Milling

STANDARD CUTTING CONDITIONS

09 type

ISO	Workpiece material	Hardness	Priority	Insert type	Grade	Chip-breaker	Cutting speed Vc (m/min)	Feed per tooth fz (mm/t)	
P	Carbon steel S45C, S55C, etc. C45, C55, etc.	- 300HB	First choice	ZER	AH3225	MM	100 - 300	0.5 - 1.5	
			Fracture resistance	ZER	AH3135	MM	100 - 300	0.5 - 1.5	
			Wear resistance	UER	AH3225	MM	100 - 300	0.5 - 1.5	
	Alloy steel SCM440, etc. 42CrMo4, etc.	- 300HB	First choice	ZER	AH3225	MM	100 - 200	0.5 - 1.5	
			Fracture resistance	ZER	AH3135	MM	100 - 200	0.5 - 1.5	
			Wear resistance	UER	AH3225	MM	100 - 200	0.5 - 1.5	
	Prehardened steel NAK80, PX5, etc.	30 - 40HRC	First choice	ZER	AH3225	MM	100 - 200	0.5 - 1.2	
			Fracture resistance	ZER	AH3135	MM	100 - 200	0.5 - 1.2	
			Wear resistance	UER	AH3225	MM	100 - 200	0.5 - 1.2	
M	Austenitic stainless steel SUS304, etc. X5CrNi18-9, etc.	- 200HB	First choice	UER	AH3135	MM	100 - 150	0.5 - 1.2	
			Fracture resistance	UER	AH130	MM	100 - 150	0.5 - 1.2	
			Low cutting force	ZER	AH3135	MM	100 - 150	0.5 - 1.2	
	Precipitation hardening stainless steel SUS630, etc. X20CrNiCuNb-16-4, etc.	28HRC - (H1150)	First choice	UER	AH3135	MM	80 - 150	0.3 - 1.2	
			Fracture resistance	UER	AH130	MM	80 - 150	0.3 - 1.2	
		40HRC - (H900)	First choice	UER	AH3135	MM	80 - 120	0.3 - 0.8	
Fracture resistance	UER		AH130	MM	80 - 120	0.3 - 0.8			
K	Gray cast iron FC250, FC300, etc., 250, 300, etc.	150 - 250HB	First choice	ZER	AH8015	MM	100 - 300	0.5 - 2	
			Fracture resistance	ZER	AH120	MM	100 - 300	0.5 - 2	
			Low cutting force	ZER	AH120	MM	80 - 200	0.5 - 2	
	Ductile cast iron FCD600, etc., 600-3, etc.	150 - 250HB	First choice	UER	AH130	MM	30 - 60	0.3 - 0.7	
			Wear resistance	UER	AH8015	MM	30 - 60	0.3 - 0.7	
			Low cutting force	ZER	AH130	MM	30 - 60	0.3 - 0.7	
S	Titanium alloys Ti-6Al-4V, etc.	- 40HRC	First choice	UER	AH8015	MM	20 - 50	0.1 - 0.3	
			Fracture resistance	UER	AH130	MM	20 - 50	0.1 - 0.3	
			Low cutting force	ZER	AH8015	MM	20 - 50	0.1 - 0.3	
	Heat-resistance alloys Inconel, Hastelloy, etc.	- 40HRC	First choice	UER	AH8015	MM	80 - 130	0.1 - 0.3	
			Fracture resistance	UER	AH130	MM	80 - 130	0.1 - 0.3	
			Low cutting force	ZER	AH8015	MM	80 - 130	0.1 - 0.3	
H	Hardened steel	SKD61, etc. X40CrMoV5-1, etc.	40 - 50HRC	First choice	UER	AH8015	MM	80 - 130	0.1 - 0.3
				Fracture resistance	UER	AH130	MM	80 - 130	0.1 - 0.3
				Low cutting force	ZER	AH8015	MM	80 - 130	0.1 - 0.3

15 type

ISO	Workpiece material	Hardness	Priority	Insert type	Grade	Chip-breaker	Cutting speed Vc (m/min)	Feed per tooth fz (mm/t)	
P	Carbon steel S45C, S55C, etc. C45, C55, etc.	- 300HB	First choice	ZER	AH3135	MM	100 - 300	0.5 - 1.5	
			Wear resistance	ZER	AH120	MM	100 - 300	0.5 - 1.5	
			Fracture resistance	ZER	AH3135	MT	100 - 300	0.5 - 2	
	Alloy steel SCM440, etc. 42CrMo4, etc.	- 300HB	First choice	ZER	AH3135	MM	100 - 200	0.5 - 1.5	
			Wear resistance	ZER	AH120	MM	100 - 200	0.5 - 1.5	
			Fracture resistance	ZER	AH3135	MT	100 - 200	0.5 - 2	
	Prehardened steel NAK80, PX5, etc.	30 - 40HRC	First choice	ZER	AH3135	MM	100 - 200	0.5 - 1.2	
			Wear resistance	ZER	AH120	MM	100 - 200	0.5 - 1.2	
			Fracture resistance	ZER	AH3135	MT	100 - 200	0.5 - 1.5	
M	Austenitic stainless steel SUS304, etc., X5CrNi18-9, etc.	- 200HB	First choice	UER	AH3135	MM	100 - 150	0.5 - 1.2	
			Low cutting force	ZER	AH3135	MM	100 - 150	0.5 - 1.2	
			Fracture resistance	ZER	AH3135	MM	100 - 150	0.5 - 1.2	
	Precipitation hardening stainless steel SUS630, etc. X20CrNiCuNb-16-4, etc.	28HRC - (H1150)	First choice	UER	AH3135	MM	80 - 150	0.3 - 1.2	
			Low cutting force	ZER	AH3135	MM	80 - 150	0.3 - 1.2	
		40HRC - (H900)	First choice	UER	AH3135	MM	80 - 120	0.3 - 0.8	
Low cutting force	ZER		AH3135	MM	80 - 120	0.3 - 0.8			
K	Gray cast iron FC250, FC300, etc. 250, 300, etc.	150 - 250HB	First choice	ZER	AH120	MT	100 - 300	0.5 - 2	
			Fracture resistance	ZER	AH3135	MT	100 - 300	0.5 - 2	
			Low cutting force	ZER	AH120	MM	100 - 300	0.5 - 1.5	
	Ductile cast iron FCD600, etc. 600-3, etc.	150 - 250HB	First choice	ZER	AH120	MT	80 - 200	0.5 - 2	
			Fracture resistance	ZER	AH3135	MT	80 - 200	0.5 - 2	
			Low cutting force	ZER	AH120	MM	80 - 200	0.5 - 1.5	
S	Titanium alloys Ti-6Al-4V, etc.	- 40HRC	First choice	UER	AH3135	MM	30 - 60	0.3 - 0.7	
			Low cutting force	ZER	AH3135	MM	30 - 60	0.3 - 0.7	
			Fracture resistance	ZER	AH3135	MT	30 - 60	0.3 - 0.7	
	Heat-resistance alloys Inconel, Hastelloy, etc.	- 40HRC	First choice	UER	AH3135	MM	20 - 50	0.1 - 0.3	
			Wear resistance	ZER	AH120	MM	20 - 50	0.1 - 0.3	
			Low cutting force	ZER	AH120	MM	20 - 50	0.1 - 0.3	
H	Hardened steel	SKD61, etc. X40CrMoV5-1, etc.	40 - 50HRC	First choice	ZER	AH3135	MT	80 - 130	0.1 - 0.3
				Wear resistance	ZER	AH120	MT	80 - 130	0.1 - 0.3
		SKD11, etc. X153CrMoV12, etc.	50 - 60HRC	First choice	ZER	AH120	MT	50 - 70	0.05 - 0.2

Tool dia.: DCX (mm), Number of revolutions: n (min^{-1}), Feed speed: V_f (mm/min), Number of inserts: z

$\varnothing 25, z=3$		$\varnothing 32, z=4$		$\varnothing 40, z=5$		$\varnothing 50, z=7$	
n	V_f	n	V_f	n	V_f	n	V_f
2,550	7,650	1,990	7,960	1,590	7,950	1,270	8,890
$V_c = 200 \text{ m/min}, fz = 1 \text{ mm/t}$							
1,910	5,730	1,490	5,960	1,190	5,950	960	6,720
$V_c = 150 \text{ m/min}, fz = 1 \text{ mm/t}$							
1,910	4,580	1,490	4,770	1,190	4,760	960	5,380
$V_c = 150 \text{ m/min}, fz = 0.8 \text{ mm/t}$							
1,530	3,670	1,190	3,810	960	3,840	760	4,260
$V_c = 120 \text{ m/min}, fz = 0.8 \text{ mm/t}$							
1,530	3,670	1,190	3,810	960	3,840	760	4,260
$V_c = 120 \text{ m/min}, fz = 0.8 \text{ mm/t}$							
1,270	2,290	1,000	2,400	800	2,400	640	2,690
$V_c = 100 \text{ m/min}, fz = 0.6 \text{ mm/t}$							
2,550	9,180	1,990	9,550	1,590	9,540	1,270	10,670
$V_c = 200 \text{ m/min}, fz = 1.2 \text{ mm/t}$							
1,910	6,880	1,490	7,150	1,190	7,140	1,270	10,670
$V_c = 150 \text{ m/min}, fz = 1.2 \text{ mm/t}$							
510	770	400	800	320	800	250	880
$V_c = 40 \text{ m/min}, fz = 0.5 \text{ mm/t}$							
380	230	300	240	240	240	190	270
$V_c = 30 \text{ m/min}, fz = 0.2 \text{ mm/t}$							
1,270	760	1,000	800	800	800	640	900
$V_c = 100 \text{ m/min}, fz = 0.2 \text{ mm/t}$							

Tool dia.: DCX (mm), Number of revolutions: n (min^{-1}), Feed speed: V_f (mm/min), Number of inserts: z

$\varnothing 50, z=3$		$\varnothing 63, z=4$		$\varnothing 80, z=5$		$\varnothing 100, z=6$		$\varnothing 125, z=7$		$\varnothing 160, z=8$	
n	V_f	n	V_f	n	V_f	n	V_f	n	V_f	n	V_f
1,270	3,810	1,010	4,040	800	4,000	640	3,840	510	3,570	400	3,200
$V_c = 200 \text{ m/min}, fz = 1 \text{ mm/t}$											
1,270	4,570	1,010	4,850	800	4,800	640	4,610	510	4,280	400	3,840
$V_c = 200 \text{ m/min}, fz = 1.2 \text{ mm/t}$											
960	2,880	760	3,040	600	3,000	480	2,880	380	2,660	300	2,400
$V_c = 150 \text{ m/min}, fz = 1 \text{ mm/t}$											
960	3,460	760	3,650	600	3,600	480	3,460	380	3,190	300	2,880
$V_c = 150 \text{ m/min}, fz = 1.2 \text{ mm/t}$											
960	2,300	760	2,430	600	2,400	480	2,300	380	2,130	300	1,920
$V_c = 150 \text{ m/min}, fz = 0.8 \text{ mm/t}$											
960	2,880	760	3,040	600	3,000	480	2,880	380	2,660	300	2,400
$V_c = 150 \text{ m/min}, fz = 1 \text{ mm/t}$											
760	1,820	610	1,950	480	1,920	380	1,820	310	1,740	240	1,540
$V_c = 120 \text{ m/min}, fz = 0.8 \text{ mm/t}$											
760	1,820	610	1,950	480	1,920	380	1,820	310	1,740	240	1,540
$V_c = 120 \text{ m/min}, fz = 0.8 \text{ mm/t}$											
640	1,150	510	1,220	400	1,200	320	1,150	250	1,050	200	960
$V_c = 100 \text{ m/min}, fz = 0.6 \text{ mm/t}$											
1,270	4,570	1,010	4,850	800	4,800	640	4,610	510	4,280	400	3,840
$V_c = 200 \text{ m/min}, fz = 1.2 \text{ mm/t}$											
1,270	3,810	1,010	4,040	800	4,000	640	3,840	510	3,570	400	3,200
$V_c = 200 \text{ m/min}, fz = 1 \text{ mm/t}$											
960	3,460	760	3,650	600	3,600	480	3,460	380	3,190	300	2,880
$V_c = 150 \text{ m/min}, fz = 1.2 \text{ mm/t}$											
960	2,880	760	3,040	600	3,000	480	2,880	380	2,660	300	2,400
$V_c = 150 \text{ m/min}, fz = 1 \text{ mm/t}$											
250	380	200	400	160	400	130	390	100	350	80	320
$V_c = 40 \text{ m/min}, fz = 0.5 \text{ mm/t}$											
200	120	150	120	120	120	100	120	80	110	60	100
$V_c = 30 \text{ m/min}, fz = 0.2 \text{ mm/t}$											
640	380	510	410	400	400	320	380	250	350	200	320
$V_c = 100 \text{ m/min}, fz = 0.2 \text{ mm/t}$											
380	140	300	140	240	140	190	140	150	130	120	120
$V_c = 60 \text{ m/min}, fz = 0.12 \text{ mm/t}$											

APPLICATION RANGE

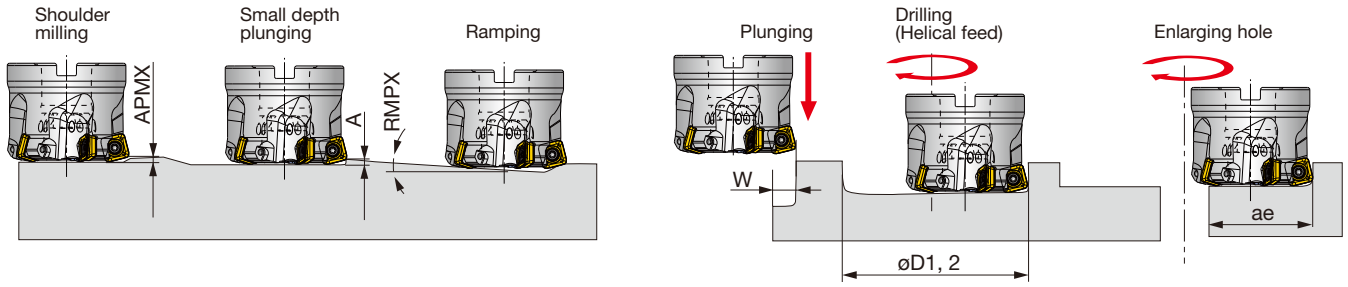

09 type

Designation	Tool dia. DCX	Max. depth of cut		Max. plunging depth A	Max. ramping angle		Max. cutting width in plunging		Min. machining dia.		Max. machining dia.		Max. cutting width in enlarging	
		APMX			RMPX		W		øD1		øD2		ae	
		SWMT 09**ZER	SWMT 09**UER			SWMT 09**ZER	SWMT 09**UER	SWMT 09**ZER	SWMT 09**UER	SWMT 09**ZER	SWMT 09**UER	SWMT 09**ZER	SWMT 09**UER	SWMT 09**ZER
EXSW09M025...	25	1.5	1	0.3	4.8	6	7	7.5	34	33	47	47	16.5	16
EXSW09M032...	32	1.5	1	0.3	2.7	3.2	7	7.5	48	47	61	61	23.5	23
TXSW09M040...	40	1.5	1	0.3	1.8	2.1	7	7.5	64	63	77	77	31.5	31
TXSW09M050...	50	1.5	1	0.3	1.2	1.4	7	7.5	84	83	97	97	41.5	41
TXSW09M052...	52	1.5	1	0.3	1.2	1.4	7	7.5	88	87	101	101	43.5	43
TXSW09M063...	63	1.5	1	0.3	0.8	1.1	7	7.5	110	109	123	123	54.5	54

15 type

Designation	Tool dia. DCX	Max. depth of cut		Max. plunging depth A	Max. ramping angle	Max. cutting width in plunging		Min. machining dia. øD1	Max. machining dia. øD2	Max. cutting width in enlarging	
		APMX				W				ae	
		SWMT 15**ZER	SWMT 15**UER			SWMT 15**ZER	SWMT 15**UER			SWMT 15**ZER	SWMT 15**UER
TXSW15M050B...	50	2.5	2	0.7	4.8°	12.5	13.5	70	95	36	35
TXSW15M063B...	63	2.5	2	0.7	2.9°	12.5	13.5	96	121	49	48
TXSW15J, M080B...	80	2.5	2	0.7	2°	12.5	13.5	130	155	66	65
TXSW15J, M100B...	100	2.5	2	0.7	1.4°	12.5	13.5	170	195	86	85
TXSW15J, M125B...	125	2.5	2	0.7	1°	12.5	13.5	220	245	111	110
TXSW15J, M160B...	160	2.5	2	0.7	0.7°	12.5	13.5	290	315	146	145

TOOL GEOMETRY FOR PROGRAMMING

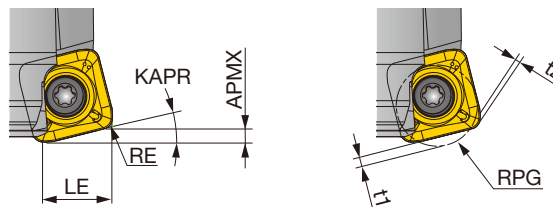

09 type

APMX (mm)		Actual corner radius RE (mm)	LE (mm)		KAPR		Programmed corner radius RPG	Uncut amount: t1 (mm)		Overcut amount: t2 (mm)	
SWMT 09**ZER	SWMT 09**UER		SWMT 09**ZER	SWMT 09**UER	SWMT 09**ZER	SWMT 09**UER		SWMT 09**ZER	SWMT 09**UER	SWMT 09**ZER	SWMT 09**UER
1.5	1	1	7.4	7.9	12°	7°	1	1.3	0.81	-	-
1.5	1	1	7.4	7.9	12°	7°	1.5	1.21	0.76	-	-
1.5	1	1	7.4	7.9	12°	7°	2	1.12	0.7	-	0.02
1.5	1	1	7.4	7.9	12°	7°	2.5	1.03	0.65	0.01	0.15
1.5	1	1	7.4	7.9	12°	7°	3	0.94	0.59	0.11	0.33

- When programming for CAM, the tool should be considered as a radius cutter. Usually, the corner radius should be set in SWMT09**ZER insert: RPG = 1.5 mm. If a larger radius is used, overcutting may occur.

15 type

APMX (mm)		Actual corner radius RE (mm)	LE (mm)		KAPR		Programmed corner radius RPG	Uncut amount: t1 (mm)		Overcut amount: t2 (mm)	
SWMT 15**ZER	SWMT 15**UER		SWMT 15**ZER	SWMT 15**UER	SWMT 15**ZER	SWMT 15**UER		SWMT 15**ZER	SWMT 15**UER	SWMT 15**ZER	SWMT 15**UER
2.5	2	2	12.7	13.8	14°	10°	3.5	2.1	1.85	-	-
2.5	2	2	12.7	13.8	14°	10°	4	1.99	1.77	-	-
2.5	2	2	12.7	13.8	14°	10°	4.5	1.88	1.69	-	0.03
2.5	2	2	12.7	13.8	14°	10°	5	1.78	1.61	0.01	0.13

- When programming for CAM, the tool should be considered as a radius cutter. Usually, the corner radius should be set in SWMT15**ZER insert: RPG = 4.5 mm, SWMT**UER insert: RPG = 4 mm. If a larger radius is used, overcutting may occur. The above table shows the uncut (t1) and overcut (t2) amounts for the programmed corner radius.

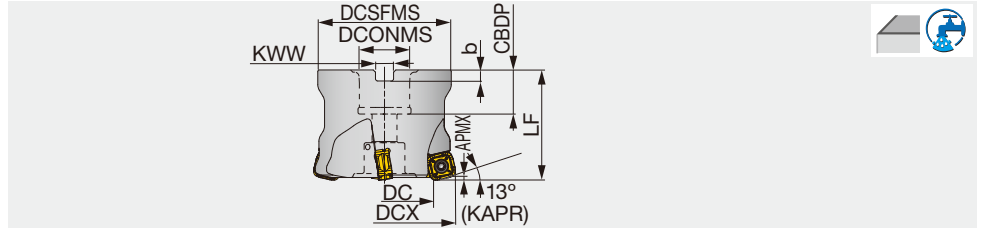

Designation	APMX	DCX	CICT	DC	DCSFMS	LF	DCONMS	CBDP	KWW	b	WT(kg)	Air hole	Insert
TXQ12R050M22.0E03	2	50	3	33.8	47	50	22	20	10.4	6.3	0.4	With	SQMU12...
TXQ12R050M22.2-03	2	50	3	33.8	47	50	22.225	20	8	5	0.4	With	SQMU12...
TXQ12R052M22.0E03	2	52	3	35.8	49	50	22	20	10.4	6.3	0.5	With	SQMU12...
TXQ12R063M22.0E04	2	63	4	46.8	59	50	22	20	10.4	6.3	0.8	With	SQMU12...
TXQ12R063M22.2-04	2	63	4	46.8	59	50	22.225	20	8	5	0.8	With	SQMU12...
TXQ12R066M27.0E04	2	66	4	49.8	63	50	27	22	12.4	7	0.9	With	SQMU12...
TXQ12R080M27.0E05	2	80	5	63.8	76	63	27	22	12.4	7	1.6	With	SQMU12...
TXQ12R080M31.7-05	2	80	5	63.8	76	63	31.75	32	12.7	8	1.5	With	SQMU12...
TXQ12R100M31.7-06	2	100	6	83.8	96	63	31.75	32	12.7	8	2.6	With	SQMU12...
TXQ12R100M32.0E06	2	100	6	83.8	96	63	32	25	14.4	8	3	With	SQMU12...
TXQ12R125M38.1-07	2	125	7	108.8	98	63	38.1	44	15.9	10	3.3	With	SQMU12...
TXQ12R125M40.0E07	2	125	7	108.8	98	63	40	32	16.4	9	3.2	With	SQMU12...

SPARE PARTS

Designation	Clamping screw	Grip	Lubricant	Shell locking bolt 1	Shell locking bolt 2	Torx bit
TXQ12R050, 052M22.0...	CSPB-4	H-TBS	M-1000	-	FSHM10-40H	BLDIP15/S7
TXQ12R063M...	CSPB-4	H-TBS	M-1000	-	CM10X30H	BLDIP15/S7
TXQ12R066, 080M27.0...	CSPB-4	H-TBS	M-1000	-	CM12X30H	BLDIP15/S7
TXQ12R080, 100M31.7...	CSPB-4	H-TBS	M-1000	-	CM16X40H	BLDIP15/S7
TXQ12R100M32.0E06	CSPB-4	H-TBS	M-1000	-	CM16X40H	BLDIP15/S7
TXQ12R125M...	CSPB-4	H-TBS	M-1000	TMBA-M20H	-	BLDIP15/S7

Recommended clamping torque: 3.5 N·m

INSERT

SQMU-MJ

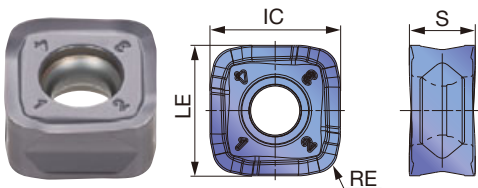

	P	M	K	N	S	H
Steel	☆					
Stainless		★	☆			
Cast iron	★		☆			
Non-ferrous				★		
Superalloys	★	☆	★			
Hard materials			★			

★ : First choice
☆ : Second choice

Designation	RE	APMX	Coated				LE	S	IC
			AH120	AH130	AH725	T3130			
SQMU1206ZSR-MJ	2	2	●	●	●	●	11.7	6	11.7

● : Line up





STANDARD CUTTING CONDITIONS

	ISO	Workpiece material	Hardness	Priority	Grades	Cutting speed Vc (m/min)	Feed per tooth fz (mm/t)
Face Milling	P	Carbon steels S45C, etc. C45, etc.	- 300 HB	First choice	AH725	100 - 300	0.5 - 2
				Wear resistance	T3130	100 - 300	0.5 - 2
				Fracture resistance	AH130	100 - 300	0.5 - 2
Shoulder Milling	P	Alloy steels SCM440, etc. 42CrMo4, etc.	- 300 HB	First choice	AH725	100 - 200	0.5 - 1.5
				Wear resistance	T3130	100 - 200	0.5 - 1.5
				Fracture resistance	AH130	100 - 200	0.5 - 1.5
Slot Milling	M	Prehardened steels NAK80, PX5, etc.	30 - 40 HRC	-	AH725	100 - 200	0.5 - 1
Slot Milling	M	Stainless steels SUS304, etc. X5CrNi18-9, etc.	- 200 HB	-	AH130	100 - 150	0.3 - 0.8
Profile Milling	K	Gray cast irons FC250, etc. 250, etc.	150 - 250 HB	-	AH120	100 - 300	0.5 - 2
		Ductile cast irons FCD600, etc. 600-3, etc.	150 - 250 HB	-	AH120	80 - 200	0.5 - 2
Chamfering, Counterbore	S	Titanium alloy Ti-6Al-4V, etc.	- 40 HRC	-	AH725	30 - 60	0.3 - 0.7
Finish Face Milling	H	Hardened steels SKD61, etc. X40CrMoV5-1, etc.	40 - 50 HRC	-	AH725	80 - 130	0.1 - 0.3
			50 - 60 HRC	-	AH725	50 - 70	0.03 - 0.07

- Slot or pocket milling is not recommended, since chip re-cutting easily occurs.
- Tool overhang length must be as short as possible to avoid chatter. When the tool overhang length is long, decrease the number of revolutions and feed.

· Cutting conditions are generally limited by the rigidity and power of the machine and the rigidity of the workpiece. When setting the conditions, start from half of the values of the standard cutting conditions and then increase the value gradually while making sure the machine is running normally.

Approach angle

- 7°-25°
- 41°-45°
- 60°-70°
- 85°-88°
- 90°
- Others

Tool dia: DCX (mm), Number of revolution: n (min^{-1}), Feed speed: V_f (mm/min), Max. depth of cut: $APM_X = 2$ mm

$\varnothing 50$		$\varnothing 63$		$\varnothing 80$		$\varnothing 100$		$\varnothing 125$	
n	V_f	n	V_f	n	V_f	n	V_f	n	V_f
1,270	4,570	1,010	4,850	790	4,740	630	4,540	500	4,200
$V_c = 200$ m/min, $f_z = 1.2$ mm/t									
950	2,850	750	3,000	590	2,950	470	2,820	380	2,660
$V_c = 150$ m/min, $f_z = 1.0$ mm/t									
950	2,280	750	2,400	590	2,360	470	2,260	380	2,130
$V_c = 150$ m/min, $f_z = 0.8$ mm/t									
760	1,140	600	1,200	470	1,180	380	1,140	300	1,050
$V_c = 120$ m/min, $f_z = 0.5$ mm/t									
1,270	4,570	1,010	4,850	790	4,740	630	4,540	500	4,200
$V_c = 200$ m/min, $f_z = 1.2$ mm/t									
950	3,420	750	3,600	590	3,540	470	3,380	380	3,190
$V_c = 150$ m/min, $f_z = 1.2$ mm/t									
250	370	200	400	150	380	120	360	100	350
$V_c = 40$ m/min, $f_z = 0.5$ mm/t									
630	380	500	400	390	390	310	370	250	350
$V_c = 100$ m/min, $f_z = 0.2$ mm/t									
380	60	300	60	235	60	190	60	150	50
$V_c = 60$ m/min, $f_z = 0.05$ mm/t									

Grade

Insert

Ext. Toolholder

Int. Toolholder

Threading

Grooving

Miniature tool

Milling cutter

Endmill

Drilling tool

Tooling System

User's Guide

Index





Brings a top performance in every operation: from high feed milling, scale removing, finish milling ... to stainless steel milling

Versatility

3 types of double sided inserts fit in the same pocket

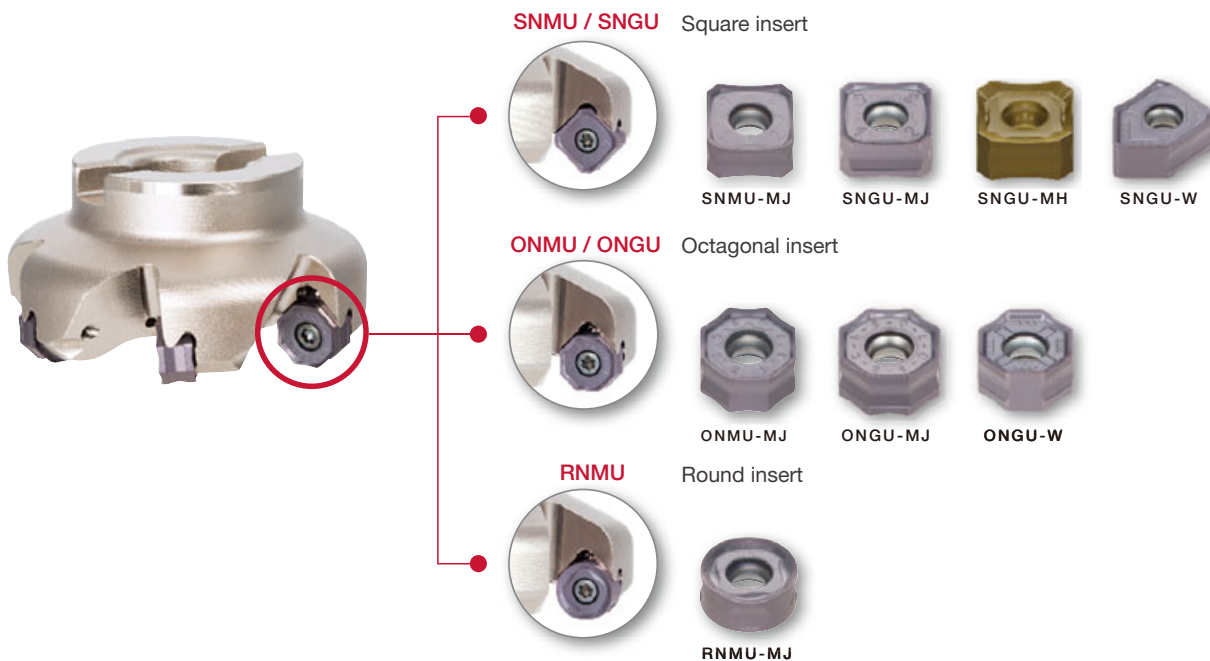

High efficiency with close pitch cutter/Extra-close pitch type available in addition to regular close pitch type

Tool line-up includes extra close pitch cutter maximizing efficiency in cast iron machining.



Standard pitch



Close pitch



Extra-close pitch

Reference pages: **H085 - H087**



Super high density PCD cutter for efficient finishing of aluminum

Super high density cutter



Super high density design
High speed cutting more than $V_c = 3,000$ m/min is possible.

Cutter diameter (mm)	Max num. of teeth	Max. rotation number (min ⁻¹)	Cutter weight (kg)
50	8	20,000	0.86
63	10	19,000	0.53
80	16	17,000	1.18
100	22	15,000	1.66
125	26	14,000	3.44
160	34	12,000	5.15

CamAdjust - super simple adjusting mechanism

Clamping insert

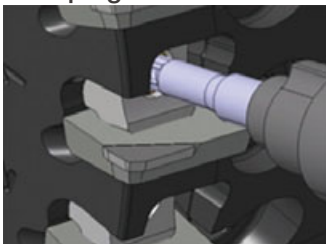

Adjusting axial runout



The same key is used for mounting and adjusting the inserts. The key wrench is operated in a single direction making insert adjustment easy on the pre-setter.

Special key wrench with adjusting cam

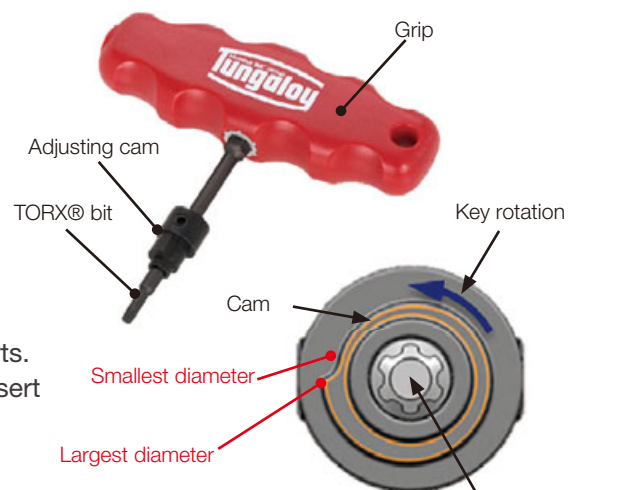

Insert's axial runout is adjusted with the eccentric cam profile.

Reference pages: **H092 - H093**



TUNG MILL

EAW13

Face endmill, shank type, with screw clamp system

GAMP=+17°~+20°,GAMF=-16°~-11°

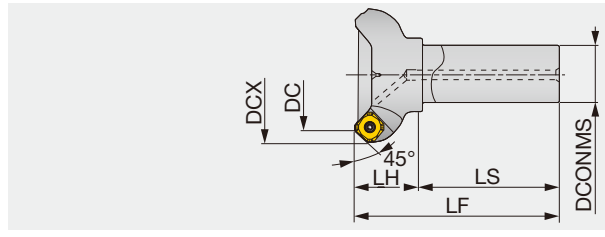

Right hand (R) shown.

Designation	DC	DCX	CICT	DCONMS	LS	LH	LF	WT(kg)	Air hole	Insert
EAW13R025M25.0-02	25	39	2	25	80	35	115	0.4	With	SW*T13...
EAW13R032M32.0-02	32	46	2	32	80	35	115	0.7	With	SW*T13...
EAW13R040M32.0-03	40	54	3	32	80	35	115	0.8	With	SW*T13...
EAW13R050M32.0-03	50	63	3	32	80	40	120	1	With	SW*T13...
EAW13R050M32.0-04	50	63	4	32	80	40	120	0.9	With	SW*T13...
EAW13R063M32.0-04	63	76	4	32	80	40	120	1.1	With	SW*T13...
EAW13R063M32.0-05	63	76	5	32	80	40	120	1.1	With	SW*T13...
EAW13R080M32.0-04	80	94	4	32	80	40	120	1.5	With	SW*T13...
EAW13R080M32.0-06	80	94	6	32	80	40	120	1.4	With	SW*T13...

TAW13

Face mill, with screw clamp system

GAMP=+17°~+20°,GAMF=-16°~-11°

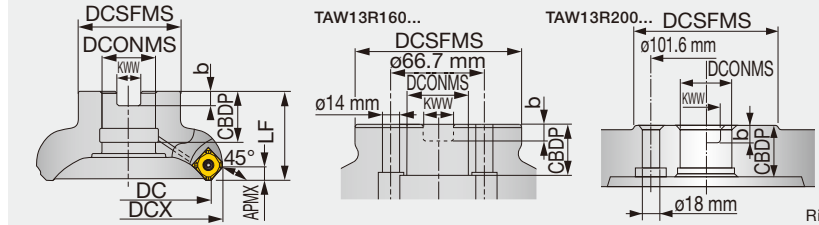
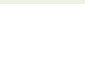
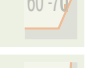

Right hand (R) shown.

Designation	DC	DCX	CICT	DCSFMS	LF	DCONMS	CBBDP	KWW	b	WT(kg)	Air hole	Insert
TAW13R050M22.0-03	50	63	3	41	40	22	20	10	6	0.4	With	SW*T13...
TAW13R050M22.0-04	50	63	4	41	40	22	20	10	6	0.4	With	SW*T13...
TAW13R050M22.0E04	50	63	4	41	40	22	20	10.4	6.3	0.4	With	SW*T13...
TAW13R050M22.0E05	50	63	5	41	40	22	20	10.4	6.3	0.4	With	SW*T13...
TAW13R063M22.0-04	63	76	4	41	40	22	20	10	6	0.5	With	SW*T13...
TAW13R063M22.0-05	63	76	5	41	40	22	20	10	6	0.6	With	SW*T13...
TAW13R063M22.0E05	63	76	5	41	40	22	20	10.4	6.3	0.6	With	SW*T13...
TAW13R063M22.0E06	63	76	6	41	40	22	20	10.4	6.3	0.6	With	SW*T13...
TAW13R080M25.4-04	80	94	4	50	50	25.4	26	9.5	6	1	With	SW*T13...
TAW13R080M25.4-06	80	94	6	50	50	25.4	26	9.5	6	1	With	SW*T13...
TAW13R080M27.0E06	80	94	6	50	50	27	22	12.4	7	1	With	SW*T13...
TAW13R080M27.0E08	80	94	8	50	50	27	22	12.4	7	1	With	SW*T13...
TAW13R100M31.7-05	100	114	5	60	50	31.75	32	12.7	8	1.5	With	SW*T13...
TAW13R100M31.7-07	100	114	7	60	50	31.75	32	12.7	8	1.5	With	SW*T13...
TAW13R100M32.0E07	100	114	7	60	50	32	28.5	14.4	8	1.5	With	SW*T13...
TAW13R100M32.0E10	100	114	10	60	50	32	28.5	14.4	8	1.5	With	SW*T13...
TAW13R125M38.1-06	125	139	6	80	63	38.1	38	15.9	10	2.8	With	SW*T13...
TAW13R125M38.1-08	125	139	8	80	63	38.1	38	15.9	10	2.7	With	SW*T13...
TAW13R125M40.0E08	125	139	8	80	63	40	32	16.4	9	2.7	With	SW*T13...
TAW13R125M40.0E12	125	139	12	80	63	40	32	16.4	9	3	With	SW*T13...
TAW13R160M40.0E10	160	174	10	100	63	40	29	16.4	9	4.4	Without	SW*T13...
TAW13R160M40.0E16	160	174	16	100	63	40	29	16.4	9	4.4	Without	SW*T13...
TAW13R160M50.8-07	160	174	7	100	63	50.8	40	19	11	4.4	Without	SW*T13...
TAW13R160M50.8-10	160	174	10	100	63	50.8	40	19	11	4.4	Without	SW*T13...
TAW13R200M47.6-08	200	213	8	130	63	47.625	38	25.4	14	8	Without	SW*T13...

SPARE PARTS

Designation	Clamping screw	Lubricant	Shim screw	Shell locking bolt 1	Shell locking bolt 2	Shim	Wrench	Wrench 1
EAW13R025*-040**	CSPB-3.5	M-1000	-	-	-	-	IP-15D	-
EAW13R050*-080**	CSPB-3.5	M-1000	DTS5-3.5SS	-	-	FSSA1102	IP-15D	P-3.5
TAW13R050 - 063...	CSPB-3.5	M-1000	DTS5-3.5SS	-	CM10X30H	FSSA1102	IP-15D	P-3.5
TAW13R080...	CSPB-3.5	M-1000	DTS5-3.5SS	-	CM12X30H	FSSA1102	IP-15D	P-3.5
TAW13R100...	CSPB-3.5	M-1000	DTS5-3.5SS	TMBA-M16H	-	FSSA1102	IP-15D	P-3.5
TAW13R125...	CSPB-3.5	M-1000	DTS5-3.5SS	TMBA-M20H	-	FSSA1102	IP-15D	P-3.5
TAW13R160...	CSPB-3.5	M-1000	DTS5-3.5SS	-	-	FSSA1102	IP-15D	P-3.5
TAW13R200...	CSPB-3.5	M-1000	DTS5-3.5SS	-	-	FSSA1102	IP-15D	P-3.5

Recommended clamping torque: 3.5 N·m

- High Feed Milling
- Face Milling
- Shoulder Milling
- Slot Milling
- Profile Milling
- Chamfering, Counterbore
- Finish Face Milling

DO PENT

EEN09

Face endmill, shank type, with screw clamp system

GAMP=-6°, GAMF=-2°~-10°

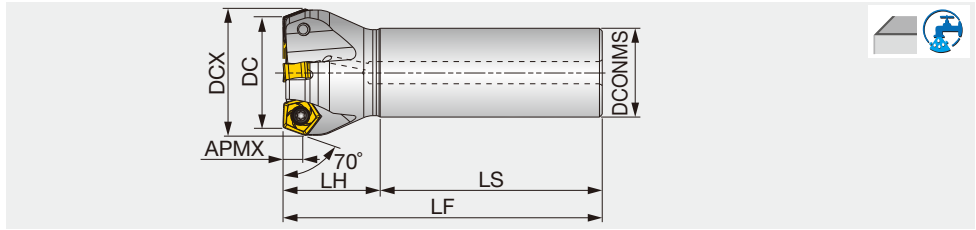

Designation	APMX	DC	DCX	CICT	DCONMS	LS	LH	LF	WT(kg)	Air hole	Insert
EEN09R032M32.0-03	6.4	32	38	3	32	80	35	115	0.7	With	PN*U0905...
EEN09R040M32.0-04	6.4	40	46	4	32	80	35	115	0.7	With	PN*U0905...
EEN09R050M32.0-04	6.4	50	56	4	32	80	40	120	0.9	With	PN*U0905...
EEN09R063M32.0-06	6.4	63	69	6	32	80	40	120	1	With	PN*U0905...
EEN09R080M32.0-07	6.4	80	86	7	32	80	40	120	1.3	With	PN*U0905...

SPARE PARTS

Designation	Clamping screw	Lubricant	Wrench
EEN09	CSTR-4L100	M-1000	T-15D

Recommended clamping torque: 3.5 N·m

Approach angle

7°-25°

41°-45°

60°-70°

85°-88°

90°

Others

Reference pages: Inserts → [H072](#), Standard cutting conditions → [H073](#)



Arbor type A

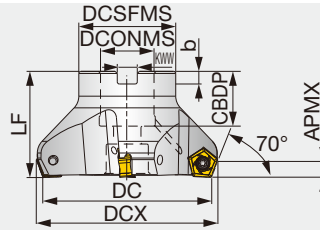

Right hand (R) shown.

Designation	APMX	DC	CICT	DCX	DCSFMS	LF	DCONMS	CDBP	KWW	b	WT(kg)	Air hole	Insert	Arbor type
TEN09R050M22.0-03	6.4	50	3	56	41	40	22	20	10	6	0.3	With	PN*U0905...	A
TEN09R050M22.0-04	6.4	50	4	56	41	40	22	20	10	6	0.3	With	PN*U0905...	A
TEN09R050M22.0-06	6.4	50	6	56	41	40	22	20	10	6	0.3	With	PN*U0905...	A
TEN09R050M22.0E04	6.4	50	4	56	41	40	22	20	10.4	6.3	0.3	With	PN*U0905...	A
TEN09R050M22.0E06	6.4	50	6	56	41	40	22	20	10.4	6.3	0.3	With	PN*U0905...	A
TEN09R063M22.0-04	6.4	63	4	69	41	40	22	20	10	6	0.5	With	PN*U0905...	A
TEN09R063M22.0-06	6.4	63	6	69	41	40	22	20	10	6	0.5	With	PN*U0905...	A
TEN09R063M22.0-08	6.4	63	8	69	41	40	22	20	10	6	0.5	With	PN*U0905...	A
TEN09R063M22.0E06	6.4	63	6	69	41	40	22	20	10.4	6.3	0.5	With	PN*U0905...	A
TEN09R063M22.0E08	6.4	63	8	69	41	40	22	20	10.4	6.3	0.5	With	PN*U0905...	A
TEN09R080M25.4-04	6.4	80	4	86	46	50	25.4	26	9.5	6	0.9	With	PN*U0905...	A
TEN09R080M25.4-07	6.4	80	7	86	46	50	25.4	26	9.5	6	0.9	With	PN*U0905...	A
TEN09R080M25.4-10	6.4	80	10	86	46	50	25.4	26	9.5	6	0.9	With	PN*U0905...	A
TEN09R080M27.0E07	6.4	80	7	86	50	50	27	22	12.4	7	0.9	With	PN*U0905...	A
TEN09R080M27.0E10	6.4	80	10	86	50	50	27	22	12.4	7	1	With	PN*U0905...	A
TEN09R100M31.7-05	6.4	100	5	106	60	50	31.75	32	12.7	8	1.3	With	PN*U0905...	A
TEN09R/L100M31.7-08*	6.4	100	8	106	60	50	31.75	32	12.7	8	1.3	With	PN*U0905...	A
TEN09R100M31.7-12	6.4	100	12	106	60	50	31.75	32	12.7	8	1.4	With	PN*U0905...	A
TEN09R/L100M32.0E08*	6.4	100	8	106	60	50	32	28.5	14.4	8	1.3	With	PN*U0905...	A
TEN09R100M32.0E12	6.4	100	12	106	60	50	32	28.5	14.4	8	1.4	With	PN*U0905...	A
TEN09R125M38.1-06	6.4	125	6	131	80	63	38.1	38	15.9	10	2.6	With	PN*U0905...	A
TEN09R/L125M38.1-10*	6.4	125	10	131	80	63	38.1	38	15.9	10	2.7	With	PN*U0905...	A
TEN09R125M38.1-16	6.4	125	16	131	80	63	38.1	43	15.9	10	2.9	With	PN*U0905...	A
TEN09R/L125M40.0E10*	6.4	125	10	131	71	63	40	32	16.4	9	2.3	With	PN*U0905...	A
TEN09R125M40.0E16	6.4	125	16	131	71	63	40	32	16.4	9	2.5	With	PN*U0905...	A
TEN09R160M50.8-07	6.4	160	7	166	100	63	50.8	46	19	11	4.4	Without	PN*U0905...	A
TEN09R/L160M40.0E12*	6.4	160	12	166	100	63	40	29	16.4	9	4	Without	PN*U0905...	A
TEN09R160M40.0E20	6.4	160	20	166	100	63	40	29	16.4	9	4.3	Without	PN*U0905...	A
TEN09R/L160M50.8-12*	6.4	160	12	166	100	63	50.8	46	19	11	4.6	Without	PN*U0905...	A
TEN09R160M50.8-20	6.4	160	20	166	100	63	50.8	46	19	11	4.9	Without	PN*U0905...	A
TEN09R200M47.6-10	6.4	200	10	206	130	63	47.625	38	25.4	14	6.5	Without	PN*U0905...	B
TEN09R200M60.0E14	6.4	200	14	206	130	63	60	38	25.7	14	6.34	Without	PN*U0905...	B
TEN09R250M47.6-12	6.4	250	12	256	130	63	47.625	38	25.4	14	12.94	Without	PN*U0905...	B
TEN09R250M60.0E16	6.4	250	16	256	130	63	60	38	25.7	14	13.46	Without	PN*U0905...	B
TEN09R315M47.6-14	6.4	315	14	321	220	63	47.625	38	25.4	14	17.9	Without	PN*U0905...	C

*Please use neutral hand inserts for TEN09L (left hand cutter).

Arbor type

Arbor type B

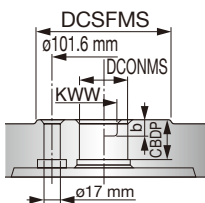

Arbor type C

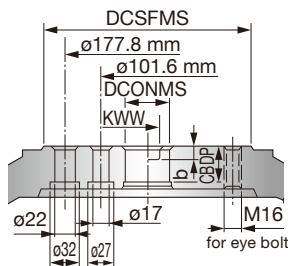

SPARE PARTS

Designation	Clamping screw	Grip	Lubricant	Shell locking bolt 1	Shell locking bolt 2	Torx bit
TEN09R050 - 063...	CSTR-4L100	H-TBS	M-1000	-	CM10X30H	BT15S
TEN09R080...	CSTR-4L100	H-TBS	M-1000	-	CM12X30H	BT15S
TEN09R/L100...	CSTR-4L100	H-TBS	M-1000	TMBA-M16H	-	BT15S
TEN09R125...06, TEN09R/L125M...10	CSTR-4L100	H-TBS	M-1000	TMBA-M20H	-	BT15M
TEN09R125M...16	CSTR-4L100	H-TBS	M-1000	TMBA-M20H	-	BT15S
TEN09R160M...07, TEN09R/L160M...12, TEN09R200M..., TEN09R250M...	CSTR-4L100	H-TBS	M-1000	-	-	BT15M
TEN09R160M...20	CSTR-4L100	H-TBS	M-1000	-	-	BT15S
TEN09R315M...	CSTR-4L100	H-TBS	M-1000	-	-	BT15L

Recommended clamping torque: 3.5 N·m

Reference pages: Inserts → **H072**, Standard cutting conditions → **H073**



- High Feed Milling
- Face Milling
- Shoulder Milling
- Slot Milling
- Profile Milling
- Chamfering, Counterbore
- Finish Face Milling
- Approach angle
- 7°-25°
- 41°-45°
- 60°-70°
- 85°-88°
- 90°
- Others

INSERT

PN*U0905GNEN-MJ (Neutral)

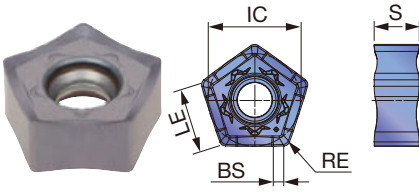

PNCU0905GNER-MJ (Right hand)

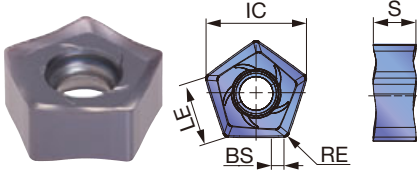

PNCU0905-ML (Neutral)

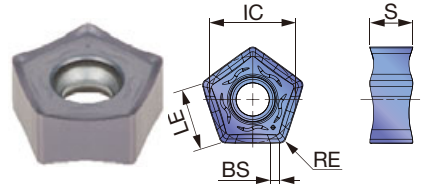

PNCU0905-AJ (Right hand)

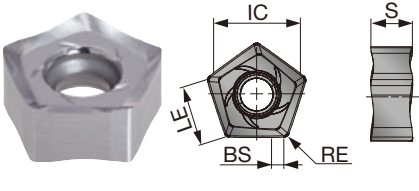

PNCU0905-W (Right hand)

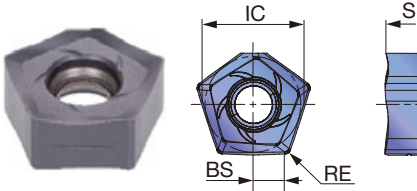

P Steel	★	☆	★	☆	★		☆	☆	★					
M Stainless			★	☆	☆		☆							
K Cast iron		☆		★	☆	★	★							
N Non-ferrous											★			
S Superalloys			☆	☆		★								
H Hard materials	★													

★ : First choice
☆ : Second choice

Designation	RE	APMX	Coated								Cermet	Uncoated	LE	S	IC	BS				
			AH3225	AH8015	AH3135	AH120	AH140	AH725	T1215	T1115	T3225	T3130					NS740	TH10		
PNMU0905GNEN-MJ	0.8	6.4	●	●	●					●							8.9	6	12.2	1.4
PNCU0905GNEN-MJ	0.8	6.4	●	●	●					●							8.9	6	12.2	1.4
PNCU0905GNER-MJ	0.8	6.4				●	●	●		●							8.9	5.93	12.2	1.4
PNCU0905GNEN-ML	0.8	6.4	●	●	●												8.9	5.96	12.2	1.4
PNCU0905GNFR-AJ	0.8	6.4										●					8.9	6.25	12.2	1.4
PNCU0905GNER-W	0.8	2						●									-	5.93	12.2	3.8

● : Line up

STANDARD CUTTING CONDITIONS

ISO	Workpiece materials	Hardness	Selection criteria	Recommended grade	Chip-breaker	Cutting speed Vc (m/min)	Feed per tooth fz (mm/t)
P	Low carbon steels S15C, C15E4, etc. C15, etc.	200 - 300 HB	First choice	AH3225	MJ	100 - 250	0.1 - 0.4
		200 - 300 HB	Low cutting force	AH3225	ML	100 - 250	0.1 - 0.3
		200 - 300 HB	Wear resistance	T3225	MJ	200 - 350	0.1 - 0.3
		200 - 300 HB	Surface quality	NS740	MJ	100 - 250	0.1 - 0.3
	High carbon steels, alloyed steels S45C, SCM440, etc. C45, 42CrMo4, etc.	150 - 300 HB	First choice	AH3225	MJ	100 - 250	0.1 - 0.35
		150 - 300 HB	Low cutting force	AH3225	ML	100 - 250	0.1 - 0.3
		150 - 300 HB	Wear resistance	T3225	MJ	180 - 300	0.1 - 0.3
		150 - 300 HB	Surface quality	NS740	MJ	100 - 250	0.1 - 0.3
	Prehardened steels NAK80, PX5, etc.	30 - 40 HRC	First choice	AH3225	MJ	100 - 200	0.1 - 0.3
		30 - 40 HRC	Low cutting force	AH3225	ML	100 - 200	0.1 - 0.25
		30 - 40 HRC	Wear resistance	T3225	MJ	150 - 250	0.1 - 0.25
	M	Stainless steels SUS304, etc. X5CrNi18-9, etc.	- 200 HB	First choice	AH3135	ML	100 - 200
- 200 HB			Fracture resistance	AH3135	MJ	100 - 200	0.1 - 0.35
- 200 HB			Wear resistance	T3225	MJ	100 - 250	0.1 - 0.3
K	Grey cast irons FCD400, etc. 250, etc.	150 - 250 HB	First choice	T1215	MJ	100 - 300	0.1 - 0.35
		150 - 250 HB	Fracture resistance	AH120	MJ	100 - 250	0.1 - 0.4
	Ductile cast irons FCD400, etc. 400-15S, etc.	150 - 250 HB	First choice	T1215	MJ	100 - 300	0.1 - 0.35
		150 - 250 HB	Fracture resistance	AH120	MJ	80 - 200	0.1 - 0.4
N	Aluminium alloys Si < 13%	-	First choice	TH10	AJ	500 - 1500	0.1 - 0.5
	Aluminium alloys Si ≥ 13%	-	First choice	TH10	AJ	150 - 500	0.1 - 0.5
S	Titanium alloys Ti-6Al-4V, etc.	- 40 HRC	First choice	AH3135	ML	30 - 60	0.1 - 0.3
		- 40 HRC	Fracture resistance	AH3135	MJ	30 - 60	0.1 - 0.3
	Heat-resistant alloys Inconel 718, etc.	- 40 HRC	First choice	AH725	MJ	10 - 40	0.04 - 0.1
H	Hardened materials SKD61, X40CrMoV5-1, etc.	- 45 HRC	First choice	AH8015	MJ	80 - 150	0.05 - 0.15
		- 45 HRC	Low cutting force	AH8015	ML	80 - 150	0.05 - 0.15

- Remove excessive chips with an air blast to prevent chip jamming.
- Use water-soluble coolant to avoid built-up edge in case extreme welding occurs on cutting edges. (ex. aluminium machining).
- For operations with a varied depth of cut (ex. casting skin) and machining of workpiece materials with interrupted surface, the feed (fz) should be set to the lower recommended value shown in the above table.

- Cutting conditions may be limited depending on machine power, workpiece rigidity, and spindle output. When the cutting width, depth or overhang length is large, set Vc and fz to the lower recommended values and check the machine power and vibration.

Installation of inserts on an extra close-pitch cutter

- On an extra close-pitch cutter, the screw hole of an insert pocket is placed at an angle.
- Leave a gap between the insert and pocket when starting to fasten the screw on the cutter body as shown in Fig. A.
- After fastening the screw, please ensure that there is no gap between the cutter body and insert. (Fig. B)

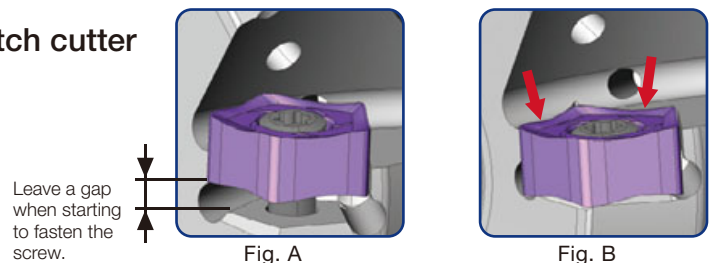

Notes for using wiper inserts

- When fine surface finish is required, wiper insert PNCU0905GNER-W is recommended.
- Attach the insert with its notch on the top, as shown in Fig. C.
- Also, make sure that the mark of the insert is located at the bottom of the cutter body, as shown in Fig. D.
- The wiper insert has two corners available (Fig. D). Do not use the other corners as the cutter body may be broken.

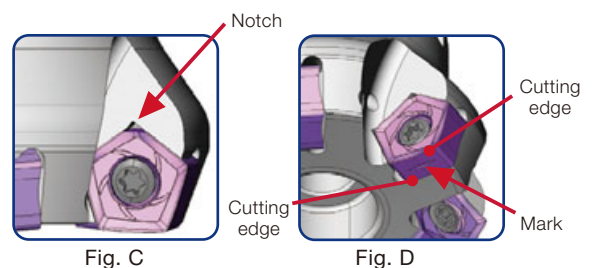

Grade
Insert
Ext. Toolholder
Int. Toolholder
Threading
Grooving
Miniature tool
Milling cutter
Endmill
Drilling tool
Tooling System
User's Guide
Index

A
B
C
D
E
F
G
H
I
J
K
L
M



ROUNDSPLIT

ERC12/16

Endmill, shank type

GAMP = +0°, GAMF = -1° ~ -5°

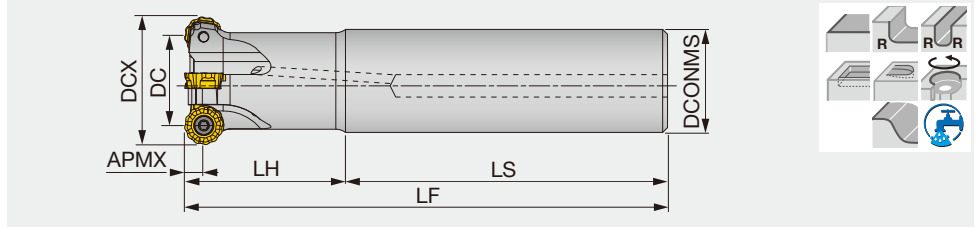

Designation	APMX	DCX	DC	CICT	DCONMS	LF	LH	LS	WT(kg)	Air hole	Insert
ERC12R032M32.0-03	6	32	20	3	32	150	70	80	0.8	With	RCMT1204...
ERC12R032M32.0-03L	6	32	20	3	32	250	150	100	1.3	With	RCMT1204...
ERC12R032M32.0-03LL	6	32	20	3	32	300	180	120	1.6	With	RCMT1204...
ERC12R033M32.0-03	6	33	21	3	32	150	70	80	0.8	With	RCMT1204...
ERC12R033M32.0-03L	6	33	21	3	32	250	150	100	1.4	With	RCMT1204...
ERC12R033M32.0-03LL	6	33	21	3	32	300	70	230	1.7	With	RCMT1204...
ERC12R040M32.0-04	6	40	28	4	32	150	50	100	0.8	With	RCMT1204...
ERC12R040M32.0-04L	6	40	28	4	32	250	50	200	1.5	With	RCMT1204...
ERC12R040M32.0-04LL	6	40	28	4	32	300	50	250	1.8	With	RCMT1204...
ERC12R050M42.0-05	6	50	38	5	42	150	50	100	1.5	With	RCMT1204...
ERC12R050M42.0-05L	6	50	38	5	42	250	50	200	2.6	With	RCMT1204...
ERC12R050M42.0-05LL	6	50	38	5	42	300	50	250	3	With	RCMT1204...
ERC16R040M32.0-02	8	40	24	2	32	150	50	100	0.8	With	RCMT1606...
ERC16R040M32.0-02L	8	40	24	2	32	250	50	200	1.4	With	RCMT1606...
ERC16R040M32.0-02LL	8	40	24	2	32	300	50	250	1.7	With	RCMT1606...
ERC16R050M42.0-03	8	50	34	3	42	150	50	100	1.4	With	RCMT1606...
ERC16R050M42.0-03L	8	50	34	3	42	250	50	200	2.4	With	RCMT1606...
ERC16R050M42.0-03LL	8	50	34	3	42	300	50	250	3	With	RCMT1606...

SPARE PARTS



Designation	Clamping screw	Wewnch
ERC12R...	CSTB-4L090	T-15DB
ERC16R040...	CSTB-5L105	T-20DB
ERC16R050...	CSTB-5L120	T-20DB

Recommended clamping torque: CSTB-4L090 = 3.5 N-m, CSTB-5L105 = 5 N-m, CSTB-5L120 = 5 N-m

Approach angle



Others

Reference pages: Inserts → [H076](#)

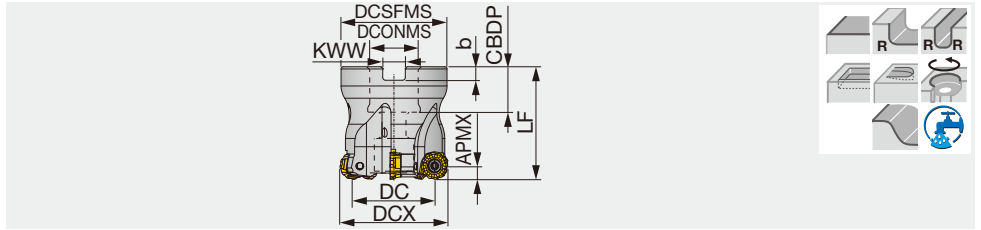

Designation	APMX	DCX	DC	CICT	DCSFMS	LF	DCONMS	CBDP	KWW	b	WT(kg)	Air hole	Insert
TRC12R040M16.0-04	6	40	28	4	35	40	16	18	8.2	5.6	0.2	With	RCMT1204...
TRC12R040M16.0E04	6	40	28	4	35	40	16	19	8.4	5.6	0.2	With	RCMT1204...
TRC12R050M22.0-05	6	50	38	5	47	50	22	20	10	6	0.4	With	RCMT1204...
TRC12R050M22.0E05	6	50	38	5	47	50	22	20	10.4	6.3	0.4	With	RCMT1204...
TRC12R050M22.2-05	6	50	38	5	47	50	22.225	20	8	5	0.4	With	RCMT1204...
TRC12R052M22.0E05	6	52	40	5	49	50	22	20	10.4	6.3	0.4	With	RCMT1204...
TRC12R063M22.0-06	6	63	51	6	59	50	22	20	10	6	0.7	With	RCMT1204...
TRC12R063M22.0E06	6	63	51	6	59	50	22	20	10.4	6.3	0.7	With	RCMT1204...
TRC12R063M22.2-06	6	63	51	6	59	50	22.225	20	8	5	0.7	With	RCMT1204...
TRC12R066M22.0E06	6	66	54	6	62	50	22	20	10.4	6.3	0.7	With	RCMT1204...
TRC12R080M27.0E07	6	80	68	7	76	50	27	22	12.4	7	1.1	With	RCMT1204...
TRC12R080M31.7-07	6	80	68	7	76	63	31.750	32	12.7	8	1.5	With	RCMT1204...
TRC16R050M22.0-04	8	50	34	4	47	50	22	20	10	6	0.4	With	RCMT1606...
TRC16R050M22.0E04	8	50	34	4	47	50	22	20	10.4	6.3	0.3	With	RCMT1606...
TRC16R050M22.2-04	8	50	34	4	47	50	22.225	20	8	5	0.4	With	RCMT1606...
TRC16R052M22.0E04	8	52	36	4	49	50	22	20	10.4	6.3	0.4	With	RCMT1606...
TRC16R063M22.0-05	8	63	47	5	59	50	22	20	10	6	0.6	With	RCMT1606...
TRC16R063M22.0E05	8	63	47	5	59	50	22	20	10.4	6.3	0.6	With	RCMT1606...
TRC16R063M22.2-05	8	63	47	5	59	50	22.225	20	8	5	0.7	With	RCMT1606...
TRC16R066M22.0E05	8	66	50	5	62	50	22	20	10.4	6.3	0.7	With	RCMT1606...
TRC16R080M27.0E06	8	80	64	6	76	50	27	22	12.4	7	1	With	RCMT1606...
TRC16R080M31.7-06	8	80	64	6	76	63	31.75	32	12.7	8	1.3	With	RCMT1606...
TRC16R100M31.7-07	8	100	84	7	96	63	31.75	32	12.7	8	1.6	With	RCMT1606...
TRC16R100M32.0E07	8	100	84	7	96	63	32	25	14.4	8	2.4	With	RCMT1606...
TRC16R125M38.1-08	8	125	109	8	98	63	38.1	43	15.9	10	3.6	With	RCMT1606...
TRC16R125M40.0E08	8	125	109	8	98	63	40	32	16.4	9	3	With	RCMT1606...

SPARE PARTS

Designation	Clamping screw	Grip	Shell locking bolt 1	Shell locking bolt 2	Torx bit
TRC12R040...	CSTB-4L090	H-TBS	-	FSHM8-30H	BT15S
TRC12R050 - 066...	CSTB-4L090	H-TBS	-	CM10X30H	BT15S
TRC12R080M27.0E07	CSTB-4L090	H-TBS	-	CM12X30H	BT15S
TRC12R080M31.7-07	CSTB-4L090	H-TBS	-	CM16X40H	BT15S
TRC16R050 - 052...	CSTB-5L120	H-TB	-	FSHM10-40H	BT20S
TRC16R063 - 066...	CSTB-5L120	H-TB	-	CM10X30H	BT20S
TRC16R080M27.0E06	CSTB-5L120	H-TB	-	CM12X30H	BT20S
TRC16R080M31.7-06	CSTB-5L120	H-TB	-	CM16X40H	BT20S
TRC16R100...	CSTB-5L120	H-TB	-	CM16X40H	BT20S
TRC16R125...	CSTB-5L120	H-TB	TMBA-M20H	-	BT20M

Recommended clamping torque: CSTB-4L090 = 3.5 N·m, CSTB-5L120 = 5 N·m





INSERT

RCMT-MJ

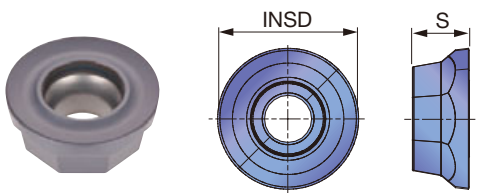

RCMT-NMJ

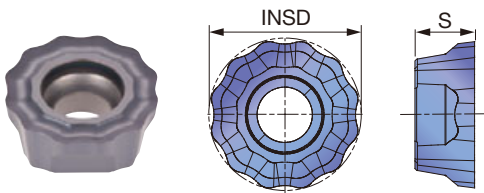

RCMT-NAJ

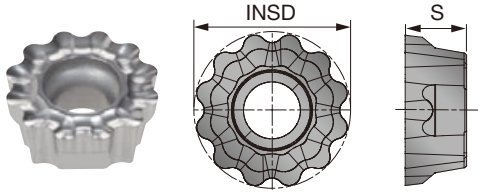

P	Steel	☆	★					
M	Stainless		★	☆				
K	Cast iron	★		☆				
N	Non-ferrous				★			
S	Superalloys	★	★					
H	Hard materials							

★ : First choice
☆ : Second choice

Designation	APMX	Coated			Uncoated	INSD	S
		AH120	AH140	AH725	KS15F		
RCMT1204EN-MJ	6	●	●	●		12	4.8
RCMT1204EN-NMJ	6	●	●	●		12	4.8
RCMT1204FN-NAJ	6				●	12	4.8
RCMT1606EN-MJ	8	●	●	●		16	6.5
RCMT1606EN-NMJ	8	●	●	●		16	6.5
RCMT1606FN-NAJ	8				●	16	6.5

● : Line up

STANDARD CUTTING CONDITIONS

Please scan below.

e-catalog



TRC12/16

e-catalog



ERC12/16

Holemaking with helical feed

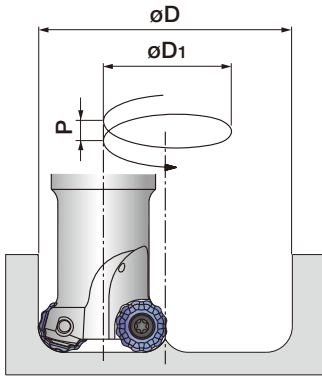

Designation	Tool ø DCX (mm)	Min. machining diameter (mm)		Max. machining diameter (mm)		Pitch P (mm)
		øD	øD1	øD	øD1	
ERC12R032...	ø32	52	20	62	30	< 6
ERC12R033...	ø33	54	21	64	31	< 6
T/ERC12R040...	ø40	68	28	78	38	< 6
T/ERC12R050...	ø50	88	38	98	48	< 6
TRC12R063...	ø63	114	51	124	61	< 6
TRC12R080...	ø80	148	68	158	78	< 6
ERC16R040...	ø40	64	24	78	38	< 8
T/ERC16R050...	ø50	84	34	98	48	< 8
TRC16R063...	ø63	110	47	124	61	< 8
TRC16R080...	ø80	144	64	158	78	< 8
TRC16R100...	ø100	184	84	198	98	< 8
TRC16R125...	ø125	234	109	248	123	< 8

When holemaking with a helical feed, the pitch (P) needs to be set at lower values than that shown above.

Ramping

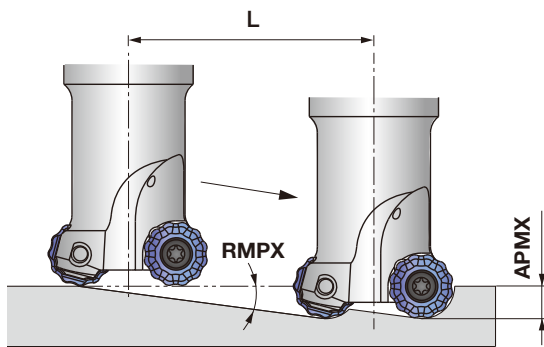

Designation	Tool ø DCX (mm)	Max. ramping angle RMPX	L: tool pass length when ramping angle is 2 degrees				
			ap (mm)				
			2	3	4	6	8
ERC12R032...	ø32	10°	57	85	114	171	-
ERC12R033...	ø33	9°	57	85	114	171	-
T/ERC12R040...	ø40	6°	57	85	114	171	-
T/ERC12R050...	ø50	4°	57	85	114	171	-
TRC12R063...	ø63	3°	57	85	114	171	-
TRC12R080...	ø80	2.3°	57	85	114	171	-
ERC16R040...	ø40	12°	57	85	114	171	229
T/ERC16R050...	ø50	7.4°	57	85	114	171	229
TRC16R063...	ø63	6°	57	85	114	171	229
TRC16R080...	ø80	4.3°	57	85	114	171	229
TRC16R100...	ø100	3°	57	85	114	171	229
TRC16R125...	ø125	2.4°	57	85	114	171	229

Tool pass length: $L = ap / \tan RMPX$, Ramping angle needs to be set at smaller than 2 degrees in order to prevent chips from getting tangled.



New
FIXRMILL
ERRQ12

Radius endmill with anti-rotation system, shank type

GAMP = +5°, GAMF = -3°

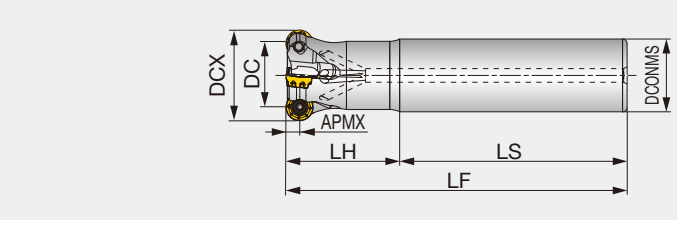

Designation	APMX	DCX	CICT	DC	DCONMS	LF	LH	LS	WT(kg)	Air hole	Insert
ERRQ12M040C32.0R04	6	40	4	28	32	150	50	100	0.84	With	RQMT12...

New
TRRQ12

Radius mill with anti-rotation system

GAMP = +5°, GAMF = -3°

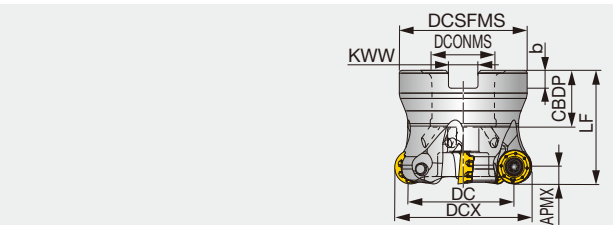

Designation	APMX	DCX	CICT	DC	DCSFMS	DCONMS	LF	CBDP	KWW	b	WT(kg)	Air hole	Insert
TRRQ12M040B16.0R04 ⁽¹⁾	6	40	4	28	34	16	40	24	8.4	5.6	0.16	With	RQMT12...
TRRQ12M050B22.0R05	6	50	5	38	45	22	40	20	10.4	6.3	0.27	With	RQMT12...
TRRQ12M050B22.0R06	6	50	6	38	45	22	40	20	10.4	6.3	0.26	With	RQMT12...
TRRQ12M052B22.0R05	6	52	5	40	45	22	40	20	10.4	6.3	0.29	With	RQMT12...
TRRQ12M063B22.0R06	6	63	6	51	50	22	40	20	10.4	6.3	0.44	With	RQMT12...
TRRQ12M063B22.0R07	6	63	7	51	50	22	40	20	10.4	6.3	0.42	With	RQMT12...
TRRQ12M080B27.0R06	6	80	6	68	56	27	50	22	12.4	7	0.88	With	RQMT12...

(1) Always use the dedicated shell locking bolt # SRPS118-0416 when assembling the cutter on the arbor. See page H082 for the instruction for the cutter-arbor assembly. Coolant needs to be supplied from the end of the arbor inlay. Coolant cannot be supplied from the shell locking bolt.

SPARE PARTS

Designation	Clamping screw	Torx bit	Grip	Shell locking bolt 1	Shell locking bolt 2
ERRQ12M040C32.0R04	CSPB-4S	BLDIP15/S7	H-TB2W	-	-
TRRQ12M040B16.0R04	CSPB-4S	BLDIP15/S7	H-TB2W	-	SRPS118-0416
TRRQ12M050 - 063...	CSPB-4S	BLDIP15/S7	H-TB2W	CM10X30H	-
TRRQ12M080B27.0R06	CSPB-4S	BLDIP15/S7	H-TB2W	CM12X30H	-

Recommended clamping torque: 3.5 N·m

INSERT

RQMT1204ENC8-MM

RQMT1204ENC6-MM

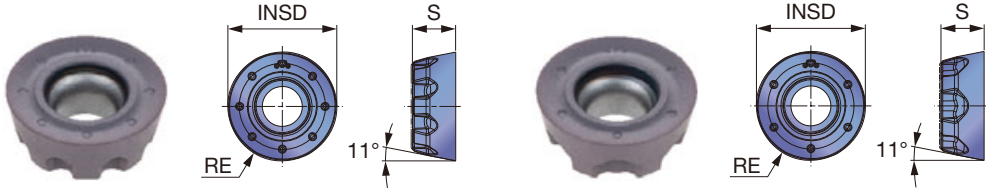

P Steel	★							
M Stainless	★							
K Cast iron		★						
N Non-ferrous								
S Superalloy	★	★						
H Hard materials	☆	☆						

★ : First choice
 ☆ : Second choice

Designation	RE	APMX	Coated		INSD	S
			AH3135	AH8015		
RQMT1204ENC8-MM	6	6	●	●	12	4.76
RQMT1204ENC6-MM	6	6	●	●	12	4.76

● : Line up

Two types of inserts

- Both inserts can be clamped in the same pocket
- Inserts can be selected based on the required depth of cut for best cost per edge

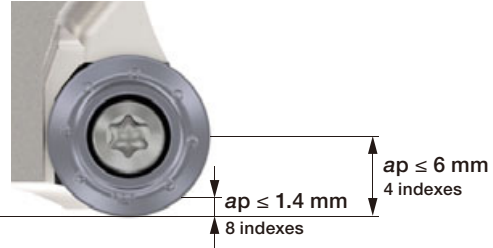

RQMT1204ENC8-MM
 Allows up to 8 indexes for 1.4 mm or smaller D.O.C. and up to 4 indexes for up to 6 mm D.O.C.

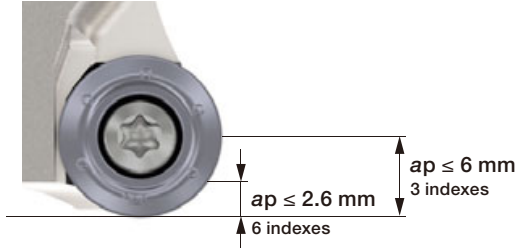

RQMT1204ENC6-MM
 Allows up to 6 indexes for 2.6 mm or smaller D.O.C. and up to 3 indexes for up to 6 mm D.O.C.

STANDARD CUTTING CONDITIONS

ISO	Workpiece materials	Hardness	Priority	Grades	Chipbreaker	Cutting speed Vc (m/min)	Feed per tooth fz (mm/t)
P	Low carbon steel S15C, etc. C15E4, etc.	- 200 HB	First choice	AH3135	MM	100 - 300	ap = 6 mm : 0.1 - 0.3 ap = 2 mm : 0.15 - 0.6 ap = 1 mm : 0.2 - 0.8
	Carbon steel and alloy steel S55C, SCM440, etc. C55, 42CrMo4, etc.	- 300 HB	First choice	AH3135	MM	100 - 250	
	Prehardened steel NAK80, PX5, etc.	30 - 40 HRC	First choice	AH3135, etc.	MM	100 - 200	
M	Austenitic stainless steel SUS304, SUS316, etc. X5CrNi18-9, X5CrNiMo17-12-3, etc.	- 200 HB	First choice	AH3135	MM	100 - 200	ap = 6 mm : 0.1 - 0.25 ap = 2 mm : 0.15 - 0.5 ap = 1 mm : 0.2 - 0.65
	Martensitic stainless steel SUS420J1, etc. X20Cr13, etc.	- 200 HB	First choice	AH3135	MM	100 - 300	
K	Grey cast iron FC250, etc. 250, etc.	150 - 250 HB	First choice	AH8015	MM	100 - 300	ap = 6 mm : 0.1 - 0.3 ap = 2 mm : 0.15 - 0.6 ap = 1 mm : 0.2 - 0.8
	Ductile cast iron FCD400, FCD600, etc. 400-15S, 600-3, etc.	150 - 250 HB	First choice	AH8015	MM	80 - 250	
S	Titanium alloys Ti-6Al-4V, etc.	-	First choice	AH3135	MM	30 - 60	ap = 6 mm : 0.08 - 0.2 ap = 2 mm : 0.12 - 0.4 ap = 1 mm : 0.15 - 0.6 ap = 6 mm : 0.05 - 0.12 ap = 2 mm : 0.08 - 0.25 ap = 1 mm : 0.1 - 0.3
	Heat-resistant alloys Inconel718, etc.	-	First choice	AH8015	MM	20 - 50	
H	Hardened steel	SKD61, etc. X40CrMoV5-1, etc.	40 - 50HRC	First choice	AH3135	MM	ap = 6 mm : 0.05 - 0.12 ap = 2 mm : 0.08 - 0.25 ap = 1 mm : 0.1 - 0.3 ap = 6 mm : 0.03 - 0.1 ap = 2 mm : 0.05 - 0.12 ap = 1 mm : 0.05 - 0.15
		SKD11, etc. X153CrMoV12, etc.	50 - 60HRC	First choice	AH8015	MM	

APPLICATION RANGE

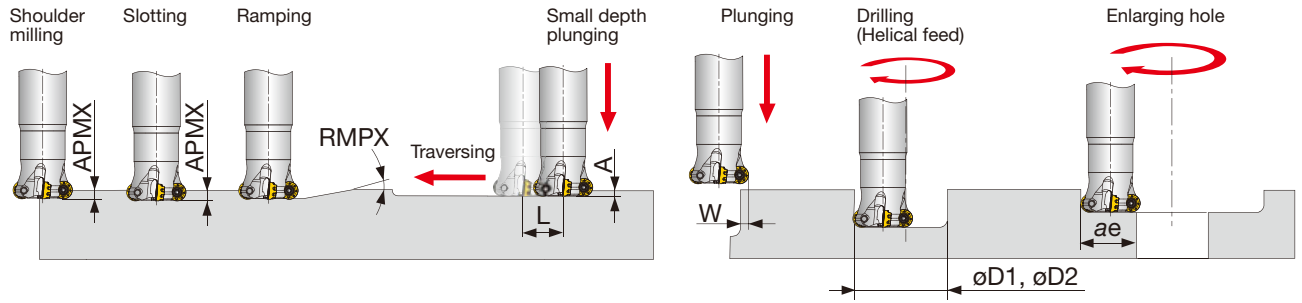

Designation	DCX	Max. depth of cut APMX	Max. ramping angle RMPX	Max. plunging depth A	Max. cutting width in plunging W	Machining length for removing uncut portion L	Min. machining diameter øD1	Max. machining diameter øD2*	Max. cutting width engagement ae
T/ERRQ12M040...	40	6	5.1°	2.4	6	29	59	79	32
TRRQ12M050B22.0...	50	6	3.6°	2.4	6	39	79	99	42
TRRQ12M052B22.0R05	52	6	3.4°	2.4	6	41	83	103	44
TRRQ12M063B22.0...	63	6	3°	2.4	6	52	105	125	55
TRRQ12M080B27.0R06	80	6	2.1°	2.4	6	69	139	159	72

* For flat bottom hole

FIXRMILL ERP

Radius endmill with anti-rotation system, shank type

GAMP = +10°~ +4°, GAMF = -2°~ -8.5°

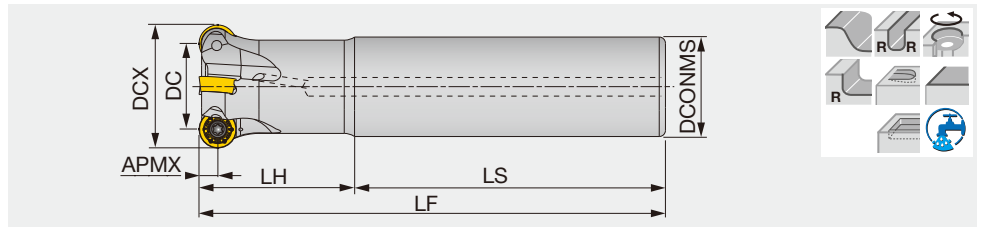

Designation	APMX	DCX	DC	CICT	DCONMS	LS	LH	LF	Air hole	Insert
ERP10R020M20.0-02	5	20	10	2	20	100	50	150	With	RPMT10T3...
ERP10R025M25.0-02	5	25	15	2	25	90	60	150	With	RPMT10T3...
ERP10R032M32.0-04	5	32	22	4	32	80	70	150	With	RPMT10T3...
ERP10R035M32.0-04	5	35	25	4	32	100	50	150	With	RPMT10T3...
ERP12R032M32.0-03	6	32	20	3	32	100	50	150	With	RPMT1204...
ERP12R040M32.0-04	6	40	28	4	32	100	50	150	With	RPMT1204...
ERP16R040M32.0-02	8	40	24	2	32	100	50	150	With	RPMT1606...

HRP-M

Radius endmill with anti-rotation system, modular type (TungFlex)

GAMP = 1°~ 4°, GAMF = -8.5°~ 2°

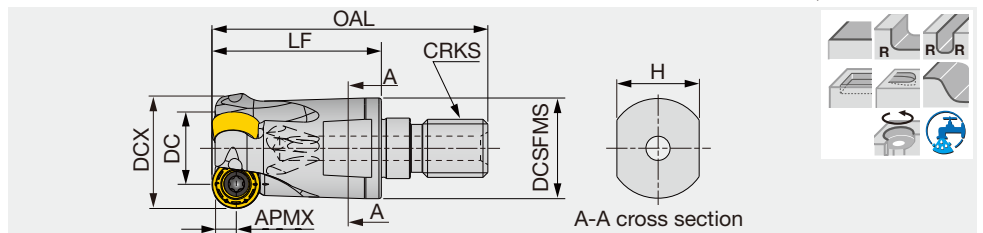

Designation	APMX	DCX	DC	CICT	OAL	LF	H	DCSFMS	CRKS	WT(kg)	Air hole	Insert
HRP10R020MM10-02	5	20	10	2	49	30	15	17.8	M10	0.1	With	RPMT10T3...
HRP10R025MM12-02	5	25	15	2	57	35	17	20.8	M12	0.1	With	RPMT10T3...
HRP10R032MM16-04	5	32	22	4	63	40	22	28.8	M16	0.2	With	RPMT10T3...
HRP12R032MM16-03	6	32	20	3	63	40	22	28.8	M16	0.2	With	RPMT1204...

SPARE PARTS

Designation	Clamping screw	Lubricant	Wrench	Wrench	
				Bit	Grip
ERP10R...	CSPB-3.5S	M-1000	IP-15D	-	-
ERP12R...	CSTR-4L100	M-1000	T-15DB	-	-
ERP16R...	CSPB-5	M-1000	IP-20D	-	-
HRP10R**	CSPB-3.5S	M-1000	-	BLD IP15/S7	H-TBS
HRP12R**	CSTR-4L100	M-1000	-	BT15S	H-TBS

Reference pages: TungFlex →
H036 - H037

Recommended clamping torque: CSPB-3.5S/CSTR-4L100 = 3.5 N·m, CSPB-5 = 5 N·m

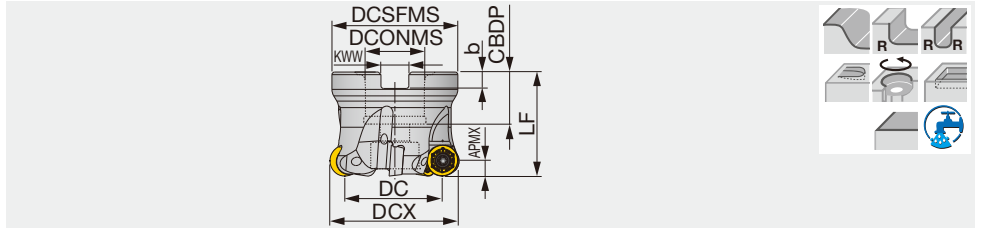

Designation	APMX	DCX	DC	CICT	DCSFMS	DCONMS	CBDP	LF	b	KWW	WT(kg)	Air hole	Insert
TRP10R040M16.0E05	5	40	30	5	35	16	18	40	5.6	8.4	0.2	With	RPMT10T3...
TRP12R050M22.0E05	6	50	38	5	47	22	20	40	6.3	10.4	0.3	With	RPMT1204...
TRP12R052M22.0E05	6	52	40	5	49	22	20	40	6.3	10.4	0.3	With	RPMT1204...
TRP12R063M22.0E06	6	63	51	6	59	22	20	40	6.3	10.4	0.6	With	RPMT1204...
TRP12R066M27.0E06	6	66	54	6	62	27	22	40	7	12.4	0.6	With	RPMT1204...
TRP16R063M22.0E05	8	63	47	5	59	22	20	40	6.3	10.4	0.6	With	RPMT1606...
TRP16R066M27.0E05	8	66	50	5	62	27	22	40	7	12.4	0.7	With	RPMT1606...

SPARE PARTS

Designation	Clamping screw	Grip	Lubricant	Shell locking bolt	Torx bit
TRP10R040M16.0E05	CSPB-3.5S	H-TBS	M-1000	FSHM8-30H	BLDIP15/S7
TRP12R050 - 063M22.0...	CSTR-4L100	H-TBS	M-1000	CM10X30H	BT15S
TRP12R066M27.0E06	CSTR-4L100	H-TBS	M-1000	CM12X30H	BT15S
TRP16R063M22.0E05	CSPB-5	H-TBS	M-1000	CM10X30H	BLDIP20/S7
TRP16R066M27.0E05	CSPB-5	H-TBS	M-1000	CM12X30H	BLDIP20/S7

Recommended clamping torque: CSPB-3.5S/CSTR-4L100 = 3.5 N·m, CSPB-5 = 5 N·m

INSERT

RPMT-MJ

RPMT-ML

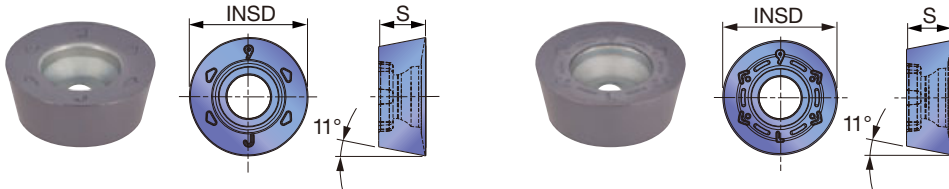

	P	M	K	N	S	H
Steel	★					
Stainless	★	☆	★			
Cast iron		☆				
Non-ferrous						
Superalloy	☆	★				
Hard materials						

★ : First choice
☆ : Second choice

Designation	RE	APMX	Coated			INSD	S
			AH130	AH725	AH4035		
RPMT10T3EN-MJ		5	●	●	●	10	3.97
RPMT10T3EN-ML		5	●	●	●	10	3.97
RPMT1204EN-MJ		6	●	●	●	12	4.76
RPMT1204EN-ML		6	●	●	●	12	4.76
RPMT1606EN-MJ		8	●	●	●	16	6.35
RPMT1606EN-ML		8	●	●	●	16	6.35

● : Line up

STANDARD CUTTING CONDITIONS

Please scan below.



ERP



HRP-M



TRP10/12/16



- High Feed Milling
- Face Milling
- Shoulder Milling
- Slot Milling
- Profile Milling
- Chamfering, Counterbore
- Finish Face Milling
- Approach angle
- 7°-25°
- 41°-45°
- 60°-70°
- 85°-88°
- 90°
- Others

Caution for insert clamping

When clamping an insert, please carefully locate it in the seat, fasten the screw, and make sure there is no gap between it and the body.

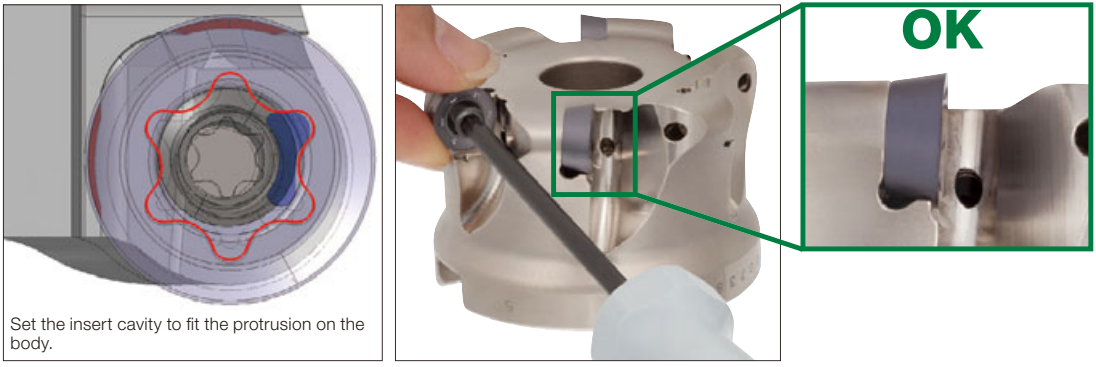

APPLICATION RANGE

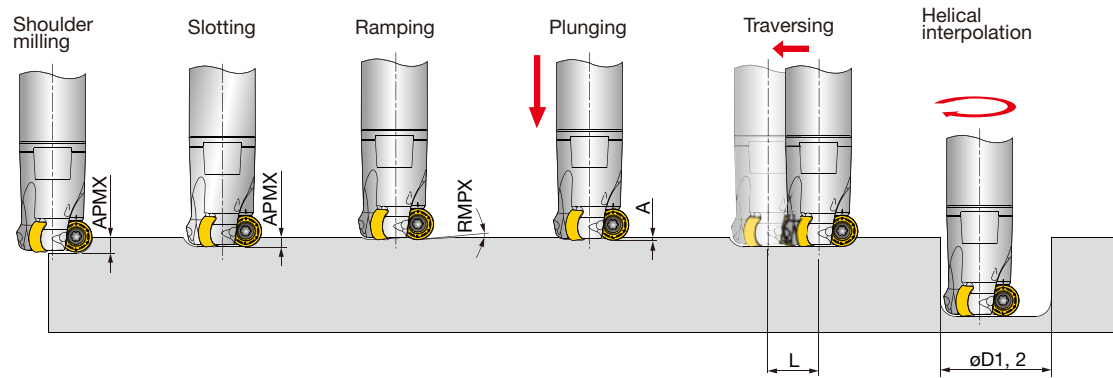

Designation	Tool-ø DCX (mm)	Max. depth of cut APMX (mm)	Max. ramping angle RMPX	Max. plunging depth A (mm)	Machining length for removing uncut portion L (mm)	Min. machining øD1 (mm)	*Max. machining øD2 (mm)
E/HRP10R020M...	20	5	2°	0.3	12	27	39
E/HRP10R025M...	25	5	3.1°	0.7	16	35	49
E/HRP10R032M...	32	5	8°	2.5	23	46	63
E/HRP12R032M...	32	6	9.2°	2.5	21	43	63
ERP10R035M32.0-04	35	5	8.2°	3	26	51	69
ERP12R040M32.0-04	40	6	3.8°	1.6	29	59	79
ERP16R040M32.0-02	40	8	7°	2.3	25	54	79
TRP10R040M16.0E05	40	5	6°	2.7	31	62	79
TRP12R050M22.0E05	50	6	4°	2.5	39	79	99
TRP12R052M22.0E05	52	6	4°	2.5	41	83	103
TRP12R063M22.0E06	63	6	3°	2.5	52	105	125
TRP12R066M27.0E06	66	6	2.8°	2.5	55	111	131
TRP16R063M22.0E05	63	8	3.3°	2.5	48	99	125
TRP16R066M27.0E05	66	8	3.1°	2.5	51	105	131

*For flat bottom hole

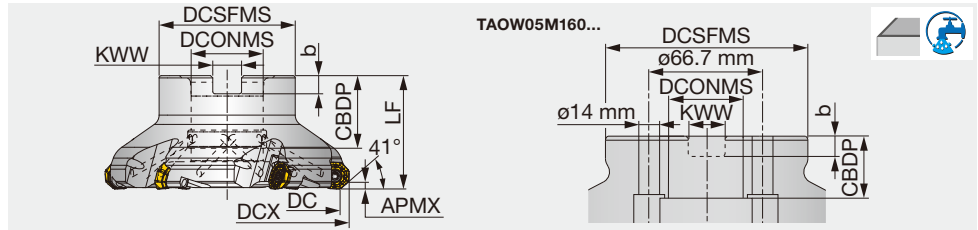

Designation	APMX	DC	DCX	CICT	DCSFMS	LF	DCONMS	CBDP	KWW	b	WT(kg)	Air hole	Insert
TAOW05M050B22.0R04	3	50	57.8	4	41	40	22	20	10.4	6.3	0.35	With	OW*T05...
TAOW05M063B22.0R05	3	63	70.7	5	47	40	22	20	10.4	6.3	0.54	With	OW*T05...
TAOW05M080B27.0R07	3	80	87.7	7	58	50	27	22	12.4	7	1.07	With	OW*T05...
TAOW05J080B25.4R05	3	80	87.7	5	58	50	25.4	26	9.5	6	1.12	With	OW*T05...
TAOW05M100B32.0R08	3	100	107.6	8	60	50	32	28.5	14.4	8	1.20	With	OW*T05...
TAOW05J100B31.7R06	3	100	107.6	6	60	50	31.75	32	12.7	8	1.27	With	OW*T05...
TAOW05M125B40.0R10	3	125	132.6	10	71	63	40	32	16.4	9	2.41	With	OW*T05...
TAOW05J125B38.1R07	3	125	132.6	7	80	63	38.1	38	15.9	10	2.72	With	OW*T05...
TAOW05M160B40.0R12	3	160	167.6	12	100	63	40	29	16.4	9	4.39	Without	OW*T05...
TAOW05J160B50.8R08	3	160	167.6	8	100	63	50.8	46	19	11	4.22	Without	OW*T05...

SPARE PARTS

Designation	Clamping screw	Grip	Torx bit	Shell locking bolt
TAOW05**050...	CSPB-4S	SW6-SD	BLDIP15/S7	CM10X30H
TAOW05**063...	CSPB-4S	SW6-SD	BLDIP15/S7	CM12X30H
TAOW05**080...	CSPB-4S	SW6-SD	BLDIP15/S7	TMBA-M16H
TAOW05**100...	CSPB-4S	SW6-SD	BLDIP15/S7	TMBA-M20H
TAOW05**125...	CSPB-4S	SW6-SD	BLDIP15/S7	TMBA-M20H
TAOW05**160...	CSPB-4S	SW6-SD	BLDIP15/S7	-

Recommended clamping torque: 3.5 N·m

INSERT

OWMT05T3AFER-MM

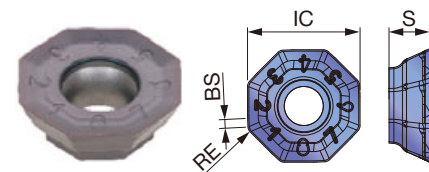

OWHT05T3C07AFER-MM

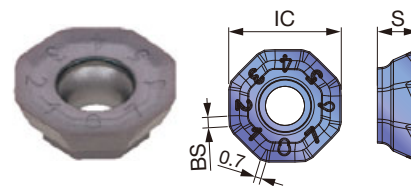

OWHT05T3C07AFER-MW

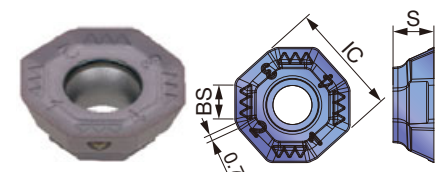

	P	M	K	N	S	H
Steel	☆	★				
Stainless		★				
Cast iron	★	☆				
Non-ferrous				★		
Superalloys				★	☆	
Hard materials						★

★ : First choice
☆ : Second choice

Designation	RE	APMX	Coated		IC	S	BS
			AH120	AH3135			
OWMT05T3AFER-MM	0.8	3	●	●	12.42	4.5	1
OWHT05T3C07AFER-MM	-	3	●	●	12.4	4.5	1.15
OWHT05T3C07AFER-MW	-	3	●	●	12.4	4.5	3.7

● : Line up

Reference pages: Standard cutting conditions → **H084**



STANDARD CUTTING CONDITIONS

ISO	Workpiece material	Hardness	Priority	Grade	Chip-breaker	Cutting speed Vc (m/min)	Feed per tooth fz (mm/t)
P	Low carbon steel (C15, etc.)	- 200 HB	First choice	AH3135	MM	100 - 300	0.05 - 0.35
			Wear resistance	AH120	MM	100 - 300	0.05 - 0.35
	High carbon and alloy steel (S55C / C55, SCM440 / 42CrMo4, etc.)	- 300 HB	First choice	AH3135	MM	100 - 250	0.05 - 0.3
			Wear resistance	AH120	MM	100 - 250	0.05 - 0.3
M	Prehardened steel (NAK80, PX5, etc.)	30 - 40 HRC	First choice	AH3135	MM	80 - 200	0.05 - 0.3
			Wear resistance	AH120	MM	80 - 200	0.05 - 0.3
M	Austenitic stainless steel (SUS304 / 1.4301, SUS316 / 1.4401, etc.)	- 200 HB	First choice	AH3135	MM	100 - 200	0.05 - 0.35
			Wear resistance	AH120	MM	100 - 200	0.05 - 0.35
	Martensitic stainless steel (X20Cr13, etc.)	- 220 HB	First choice	AH3135	MM	100 - 300	0.05 - 0.3
			Wear resistance	AH120	MM	100 - 300	0.05 - 0.3
K	Gray cast iron (FC250 / 250, etc.)	150 - 250 HB	First choice	AH120	MM	100 - 300	0.05 - 0.35
			Fracture resistance	AH3135	MM	100 - 300	0.05 - 0.35
	Ductile cast iron (FCD400 / 400-15, FCD600 / 600-3, etc.)	150 - 250 HB	First choice	AH120	MM	80 - 250	0.05 - 0.3
			Fracture resistance	AH3135	MM	80 - 250	0.05 - 0.3
S	Titanium alloys (Ti-6Al-4V, etc.)	- 40 HRC	First choice	AH3135	MM	30 - 60	0.05 - 0.2
			Wear resistance	AH120	MM	30 - 60	0.05 - 0.2
	Heat-resistant alloys (Inconel718, etc.)	- 40 HRC	First choice	AH120	MM	20 - 50	0.05 - 0.15
			Fracture resistance	AH3135	MM	20 - 50	0.05 - 0.15
H	Hardened steel (SKD61 / X40CrMoV51, etc.)	40 - 50 HRC	First choice	AH3135	MM	70 - 130	0.05 - 0.15
			Wear resistance	AH120	MM	70 - 130	0.05 - 0.15

IMPORTANT NOTES

Installing MM inserts

Before tightening the insert screw, make sure that the insert is correctly positioned in the pocket. If the screw is tightened with the insert not in place, the pocket may be damaged.

Do not use an excessive tightening torque as it may damage the pocket preventing proper positioning of the insert.

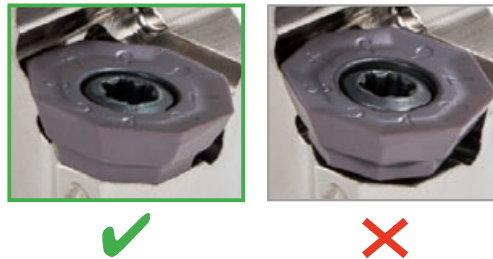

Installing MW (wiper) inserts

Wiper edge is identified with a ▼ inscribed on the insert flank. Make sure to match the ▼ mark to the ▲ mark on the cutter body when installing the wiper insert.

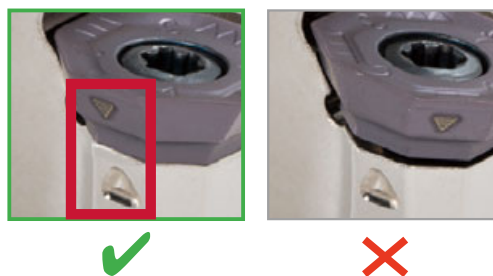

When indexing MM insert

When MM insert is used at a cutting depth of 2 mm or greater, the adjacent wiper is also engaged in the cut. Therefore, it is recommended that the insert is then rotated in the counter clockwise direction for indexing a new cutting edge.

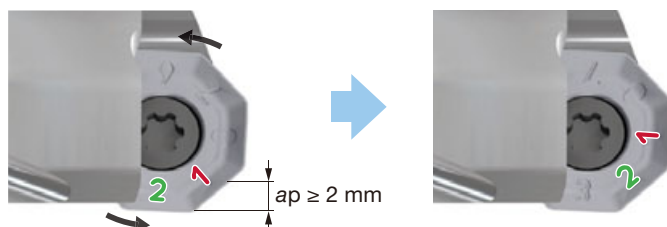

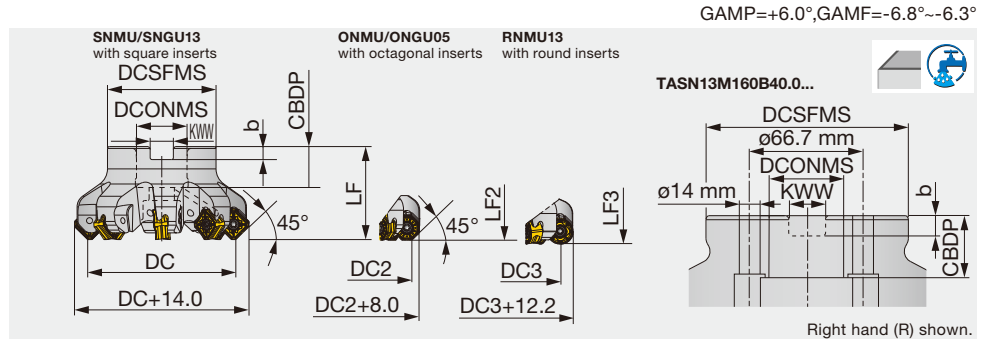

Designation	DC	DC2	DC3	CICT	DCSFMS	LF	LF2	LF3	DCONMS	CBDDP	KWW	b	WT(kg)	Air hole
TASN13M050B22.0R04	50	53	48.7	4	41	40	38.5	38.5	22	20	10.4	6.3	0.4	With
TASN13M050B22.0R05	50	53	48.7	5	41	40	38.5	38.5	22	20	10.4	6.3	0.4	With
TASN13M063B22.0R05	63	66	61.7	5	47	40	38.5	38.5	22	20	10.4	6.3	0.7	With
TASN13M063B22.0R06	63	66	61.7	6	47	40	38.5	38.5	22	20	10.4	6.3	0.6	With
TASN13M063B22.0R08	63	66	61.7	8	47	40	38.5	38.5	22	20	10.4	6.3	0.6	With
TASN13M080B27.0R05	80	83	78.7	5	58	50	48.5	48.5	27	22	12.4	7	1.1	With
TASN13M080B27.0R08	80	83	78.7	8	58	50	48.5	48.5	27	22	12.4	7	1.1	With
TASN13M080B27.0R10	80	83	78.7	10	58	50	48.5	48.5	27	22	12.4	7	1.2	With
TASN13J080B25.4R05	80	83	78.7	5	58	50	48.5	48.5	25.4	26	9.5	6	1.2	With
TASN13J080B25.4R08	80	83	78.7	8	58	50	48.5	48.5	25.4	26	9.5	6	1.1	With
TASN13J080B25.4R10	80	83	78.7	10	58	50	48.5	48.5	25.4	26	9.5	6	1.2	With
TASN13M100B32.0R06	100	103	98.7	6	60	50	48.5	48.5	32	28.5	14.4	8	1.4	With
TASN13M100B32.0R08	100	103	98.7	8	60	50	48.5	48.5	32	28.5	14.4	8	1.4	With
TASN13M100B32.0R12	100	103	98.7	12	60	50	48.5	48.5	32	28.5	14.4	8	1.4	With
TASN13J100B31.7R06	100	103	98.7	6	60	50	48.5	48.5	31.75	32	12.7	8	1.4	With
TASN13J100B31.7R08	100	103	98.7	8	60	50	48.5	48.5	31.75	32	12.7	8	1.4	With
TASN13J100B31.7R12	100	103	98.7	12	60	50	48.5	48.5	31.75	32	12.7	8	1.4	With
TASN13M125B40.0R07	125	128	123.7	7	71	63	61.5	61.5	40	32	16.4	9	2.2	With
TASN13M125B40.0R10	125	128	123.7	10	71	63	61.5	61.5	40	32	16.4	9	2.3	With
TASN13M125B40.0R14	125	128	123.7	14	71	63	61.5	61.5	40	32	16.4	9	2.5	With
TASN13J125B38.1R07	125	128	123.7	7	80	63	61.5	61.5	38.1	38	15.9	10	2.6	With
TASN13J125B38.1R10	125	128	123.7	10	80	63	61.5	61.5	38.1	38	15.9	10	2.7	With
TASN13J125B38.1R14	125	128	123.7	14	80	63	61.5	61.5	38.1	38	15.9	10	2.9	With
TASN13M160B40.0R08	160	163	158.7	8	100	63	61.5	61.5	40	29	16.4	9	4.1	Without
TASN13M160B40.0R12	160	163	158.7	12	100	63	61.5	61.5	40	29	16.4	9	4.2	Without
TASN13J160B50.8R08	160	163	158.7	8	100	63	61.5	61.5	50.8	38	19	11	4.1	Without
TASN13J160B50.8R12	160	163	158.7	12	100	63	61.5	61.5	50.8	38	19	11	4.2	Without

SPARE PARTS

Designation	Clamping screw	Grip	Lubricant	Shell locking bolt 1	Shell locking bolt 2	Torx bit
TASN13M0**B22.0R0*	CSPB-4	H-TB2W	M-1000	-	CM10X30H	BLDIP15/S7
TASN13*080B2*.R0*	CSPB-4	H-TB2W	M-1000	-	CM12X30H	BLDIP15/S7
TASN13*100B3*.R0*	CSPB-4	H-TB2W	M-1000	TMBA-M16H	-	BLDIP15/S7
TASN13*125B**.R**	CSPB-4	H-TB2W	M-1000	TMBA-M20H	-	BLDIP15/S7
TASN13*160B0*.R**	CSPB-4	H-TB2W	M-1000	-	-	BLDIP15/M7

Recommended clamping torque: 3.5 N·m

High Feed Milling

Face Milling

Shoulder Milling

Slot Milling

Profile Milling

Chamfering, Counterbore

Finish Face Milling

Approach angle

7°-25°

41°-45°

60°-70°

85°-88°

90°

Others

INSERTS

SNMU-MJ

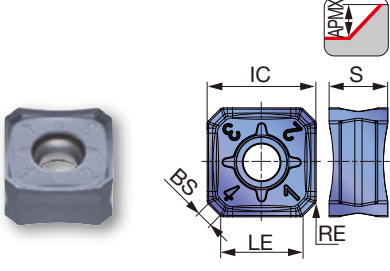

SNGU-MJ

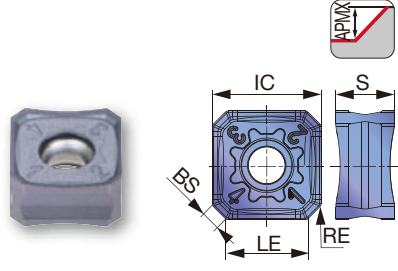

SNGU-MH

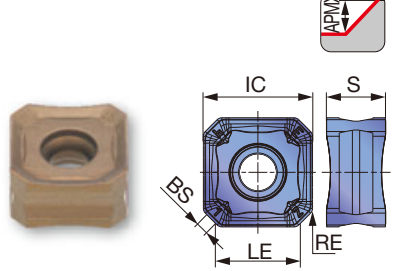

SNGU-W

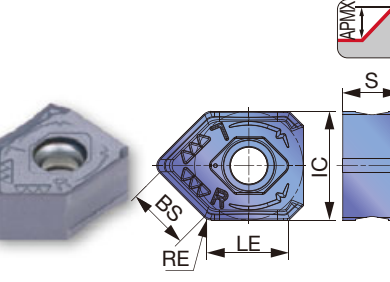

ONMU-MJ

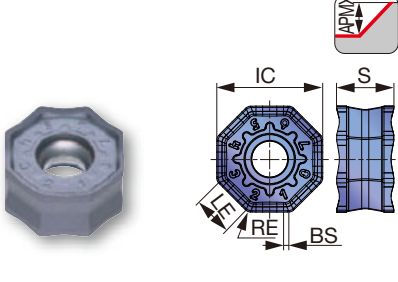

ONGU-MJ

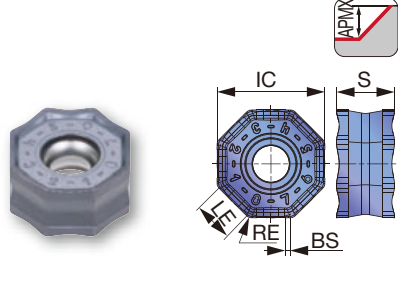

ONGU-W

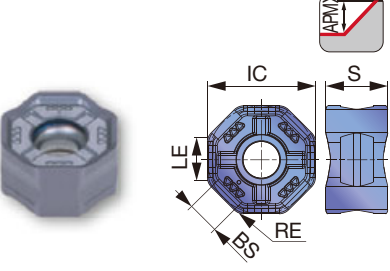

RNMU-MJ

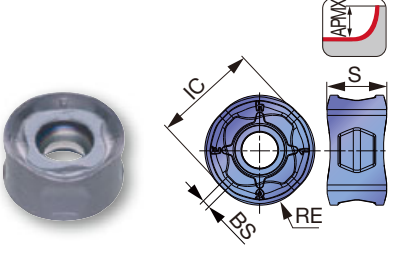

P Steel	☆	★	☆	★					
M Stainless		☆	★	★					
K Cast iron	★	☆			★				
N Non-ferrous									
S Superalloys	★		☆						
H Hard materials									

★ : First choice
☆ : Second choice

Designation	RE	APMX	Coated					LE	IC	S	BS
			AH120	AH3225	AH3135	T3225	T1215				
SNMU1307ANEN-MJ	0.5	6	●	●	●	●	●	9.4	13	7	2
SNGU1307ANEN-MJ	0.5	6	●	●	●	●	●	9.4	13	7	2
SNGU1307ANEN-MH	0.8	6				●		9	13	7	2
SNGU1307ANEN-W	1.2	6	●	●	●			9.6	13	7	7.5
ONMU0507ANEN-MJ	0.8	3.4	●	●	●	●	●	4.9	13	7	0.7
ONGU0507ANEN-MJ	0.8	3.4	●	●	●	●	●	4.9	13	7	0.7
ONGU0507ANEN-W	1.6	3.4	●	●	●			5	13	7.44	3.9
RNMU1307ZNER-MJ	6	6	●	●	●	●	●	-	13	7.26	1

● : Line up

STANDARD CUTTING CONDITIONS

SNMU / SNGU / ONMU / ONGU

ISO	Workpiece materials	Hardness	Priority	Grades	Chip-breaker	Cutting speed Vc (m/min)	Feed per tooth fz (mm/t)
P	Low carbon steel S15C, etc. C15, etc.	200 - 300HB	First choice	AH3225	MJ	100 - 250	0.1 - 0.5
			For wear resistance	T3225	MJ	200 - 350	0.1 - 0.4
	High carbon and alloy steel S55C, SCM440, etc. C55, 42CrMo4, etc.	150 - 300HB	First choice	AH3225	MJ	100 - 250	0.1 - 0.4
			For wear resistance	T3225	MJ	180 - 300	0.1 - 0.4
	Prehardened steel NAK80, PX5, etc.	30 - 40HRC	First choice	AH3225	MJ	100 - 200	0.1 - 0.4
			For wear resistance	T3225	MJ	150 - 250	0.1 - 0.4
M	Stainless steel SUS304, SUS316, etc. X5CrNi18-9, X5CrNiMo17-12-3, etc.	- 200HB	First choice	AH3135	MJ	100 - 200	0.1 - 0.35
			For wear resistance	T3225	MJ	100 - 250	0.1 - 0.3
	Cast stainless steel SCH20XNb, 1.4849, etc.	-	First choice	T3225	MH	60 - 120	0.1 - 0.3
			For low cutting force	AH3135	MJ	60 - 120	0.1 - 0.3
K	Grey cast iron FC250, etc. 250, etc.	150 - 250HB	First choice	T1215	MJ	100 - 300	0.1 - 0.4
	Ductile cast iron FCD600, etc. 600-3, etc.	150 - 250HB	First choice	AH120	MJ	100 - 250	0.1 - 0.5
S	Titanium alloys Ti-6Al-4V, etc.	- 40HRC	First choice	AH3135	MJ	30 - 60	0.1 - 0.3
	Heat-resistant alloys Inconel718, etc.	- 40HRC	First choice	AH120	MJ	10 - 40	0.05 - 0.15
H	Hardened steel	SKD61, etc. X40CrMoV5-1, etc.	First choice	AH3225	MJ	80 - 130	0.1 - 0.2
		SKD11, etc. X153CrMoV12, etc.	First choice	AH120	MJ	50 - 70	0.03 - 0.1

RNMU

ISO	Workpiece materials	Hardness	Priority	Grades	Chip-breaker	Cutting speed Vc (m/min)	Feed per tooth fz (mm/t)
P	Low carbon steel S15C, etc. C15, etc.	200 - 300HB	First choice	AH3225	MJ	100 - 250	
			For wear resistance	T3225	MJ	200 - 350	
	High carbon and alloy steel S55C, SCM440, etc. C55, 42CrMo4, etc.	150 - 300HB	First choice	AH3225	MJ	100 - 250	※ap = 6 mm : 0.1 - 0.3
			For wear resistance	T3225	MJ	180 - 300	※ap = 2 mm : 0.4 - 0.8 ※ap = 1 mm : 0.8 - 1.5
	Prehardened steel NAK80, PX5, etc.	30 - 40HRC	First choice	AH3225	MJ	100 - 200	
			For wear resistance	T3225	MJ	150 - 250	
M	Stainless steel SUS304, SUS316, etc. X5CrNi18-9, X5CrNiMo17-12-3, etc.	- 200HB	First choice	AH3135	MJ	100 - 200	※ap = 6 mm : 0.1 - 0.25 ※ap = 2 mm : 0.3 - 0.7
			For wear resistance	T3225	MJ	100 - 250	※ap = 1 mm : 0.6 - 1.3
	Cast stainless steel SCH20XNb, 1.4849, etc.	-	First choice	T3225	MJ	60 - 120	※ap = 2 mm : 0.2 - 0.4
			For fracture resistance	AH3135	MJ	60 - 120	※ap = 1 mm : 0.3 - 0.8
K	Grey cast iron FC250, etc. 250, etc.	150 - 250HB	First choice	AH120	MJ	100 - 300	
	Ductile cast iron FCD600, etc. 600-3, etc.	150 - 250HB	First choice	T1215	MJ	100 - 250	※ap = 6 mm : 0.1 - 0.3 ※ap = 2 mm : 0.4 - 0.8 ※ap = 1 mm : 0.8 - 1.5
S	Titanium alloys Ti-6Al-4V, etc.	- 40HRC	First choice	AH3135	MJ	30 - 60	ap = 1 mm : 0.15 - 0.8
	Heat-resistant alloys Inconel718, etc.	- 40HRC	First choice	AH120	MJ	10 - 40	ap = 1 mm : 0.05 - 0.3
H	Hardened steel	SKD61, etc. X40CrMoV5-1, etc.	First choice	AH3225	MJ	80 - 130	ap = 1 mm : 0.1 - 0.25
		SKD11, etc. X153CrMoV12, etc.	First choice	AH120	MJ	50 - 70	ap = 0.5 mm : 0.03 - 0.1

※ When using T3225 or T1215, decrease the feed per tooth (fz) to 80% of the above mentioned value.

Grade
Insert
Ext. Toolholder
Int. Toolholder
Threading
Grooving
Miniature tool
Milling cutter
Endmill
Drilling tool
Tooling System
User's Guide
Index



TAN07

Face mill, with screw clamp system

GAMP=-6°, GAMF=+15.5°

- Face Milling
- Shoulder Milling
- Slot Milling
- Profile Milling
- Chamfering, Counterbore
- Finish Face Milling

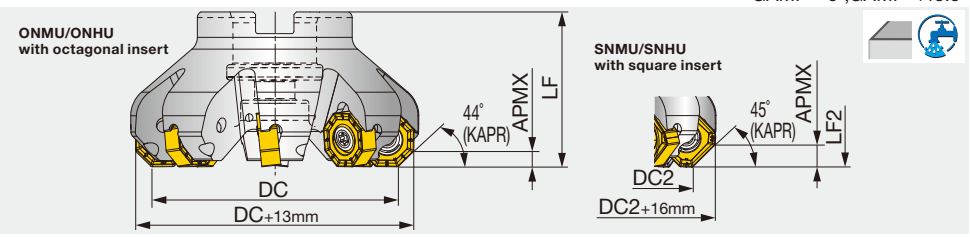

Designation	DC	DC2	CICT	DCSFMS	LF	LF2	DCONMS	CBDP	KWW	b	WT(kg)	Air hole	Insert	Arbor type
TAN07R063M22.0E05	63	60.3	5	41	40	41.4	22	20	10.4	6.3	0.5	with	SN*U/ON*U/OWMT...	A
TAN07R063M22.0E06	63	60.3	6	41	40	41.4	22	20	10.4	6.3	0.5	with	SN*U/ON*U/OWMT...	A
TAN07R080M25.4-06	80	77.3	6	50	50	51.4	25.4	26	9.5	6	1	with	SN*U/ON*U/OWMT...	A
TAN07R080M25.4-08	80	77.3	8	50	50	51.4	25.4	26	9.5	6	1	with	SN*U/ON*U/OWMT...	A
TAN07R080M27.0E06	80	77.3	6	50	50	51.4	27	22	12.4	7	1	with	SN*U/ON*U/OWMT...	A
TAN07R080M27.0E08	80	77.3	8	50	50	51.4	27	22	12.4	7	1	with	SN*U/ON*U/OWMT...	A
TAN07R100M31.7-07	100	97.3	7	60	50	51.4	31.75	32	12.7	8	1.5	with	SN*U/ON*U/OWMT...	B
TAN07R100M31.7-10	100	97.3	10	60	50	51.4	31.75	32	12.7	8	1.5	with	SN*U/ON*U/OWMT...	B
TAN07R100M32.0E07	100	97.3	7	60	50	51.4	32	28.5	14.4	8	1.5	with	SN*U/ON*U/OWMT...	B
TAN07R100M32.0E10	100	97.3	10	60	50	51.4	32	28.5	14.4	8	1.5	with	SN*U/ON*U/OWMT...	B
TAN07R125M38.1-08	125	122.3	8	80	63	64.4	38.1	38	15.9	10	2.5	with	SN*U/ON*U/OWMT...	B
TAN07R125M38.1-12	125	122.3	12	80	63	64.4	38.1	38	15.9	10	2.5	with	SN*U/ON*U/OWMT...	B
TAN07R125M40.0E08	125	122.3	8	71	63	64.4	40	29	16.4	9	2.5	with	SN*U/ON*U/OWMT...	B
TAN07R125M40.0E12	125	122.3	12	71	63	64.4	40	29	16.4	9	2.5	with	SN*U/ON*U/OWMT...	B
TAN07R160M40.0E10	160	157.3	10	100	63	64.4	40	29	16.4	9	4	without	SN*U/ON*U/OWMT...	D
TAN07R160M40.0E15	160	157.3	15	100	63	64.4	40	29	16.4	9	4	without	SN*U/ON*U/OWMT...	D
TAN07R160M50.8-10	160	157.3	10	100	63	64.4	50.8	38	19	11	4	without	SN*U/ON*U/OWMT...	B
TAN07R160M50.8-15	160	157.3	15	100	63	64.4	50.8	38	19	11	4	without	SN*U/ON*U/OWMT...	B
TAN07R200M47.6-12	200	197.3	12	130	63	64.4	47.625	38	25.4	14	6.6	without	SN*U/ON*U/OWMT...	C
TAN07R200M47.6-18	200	197.3	18	130	63	64.4	47.625	38	25.4	14	6.7	without	SN*U/ON*U/OWMT...	C
TAN07R200M60.0E12	200	197.3	12	135	63	64.4	60	38	25.7	14	6.5	without	SN*U/ON*U/OWMT...	C
TAN07R200M60.0E18	200	197.3	18	135	63	64.4	60	38	25.7	14	6.5	without	SN*U/ON*U/OWMT...	C
TAN07R250M47.6-15	250	247.3	15	130	63	64.4	47.625	38	25.4	14	9.3	without	SN*U/ON*U/OWMT...	C
TAN07R250M47.6-21	250	247.3	21	130	63	64.4	47.625	38	25.4	14	9.4	without	SN*U/ON*U/OWMT...	C
TAN07R250M60.0E15	250	247.3	15	130	63	64.4	60	38	25.7	14	9	without	SN*U/ON*U/OWMT...	C
TAN07R250M60.0E21	250	247.3	21	130	63	64.4	60	38	25.7	14	9	without	SN*U/ON*U/OWMT...	C
TAN07R315M47.6-18	315	312.3	18	220	63	64.4	47.625	38	25.4	14	17.9	without	SN*U/ON*U/OWMT...	C
TAN07R315M47.6-24	315	312.3	24	220	63	64.4	47.625	38	25.4	14	18	without	SN*U/ON*U/OWMT...	C
TAN07R315M60.0E18	315	312.3	18	220	80	81.4	60	38	25.7	14	18	without	SN*U/ON*U/OWMT...	E
TAN07R315M60.0E24	315	312.3	24	220	80	81.4	60	38	25.7	14	18	without	SN*U/ON*U/OWMT...	E

Dimension when using positive type inserts (OWMT)

Designation	OWMT-ML			OWMT-HJ			
	DC3	DCX3	LF3	DC4	DC4-2	DCX4	LF4
TAN07R063M...	63.5	76	41	55.7	67.2	76.4	41.4
TAN07R080M...	80.5	93	51	72.7	84.2	93.4	51.4
TAN07R100M...	100.5	113	51	92.7	104.2	113.4	51.4
TAN07R125M...	125.5	138	64	117.7	129.2	138.4	64.4
TAN07R160M...	160.5	173	64	152.7	164.2	173.4	64.4
TAN07R200M...	200.5	213	64	192.7	204.2	213.4	64.4
TAN07R250M...	250.5	263	64	242.7	254.2	263.4	64.4
TAN07R315M...	315.5	328	64	307.7	319.2	328.4	64.4

Note: OWMT08 inserts can be only used with screw on type cutters.

Arbor type

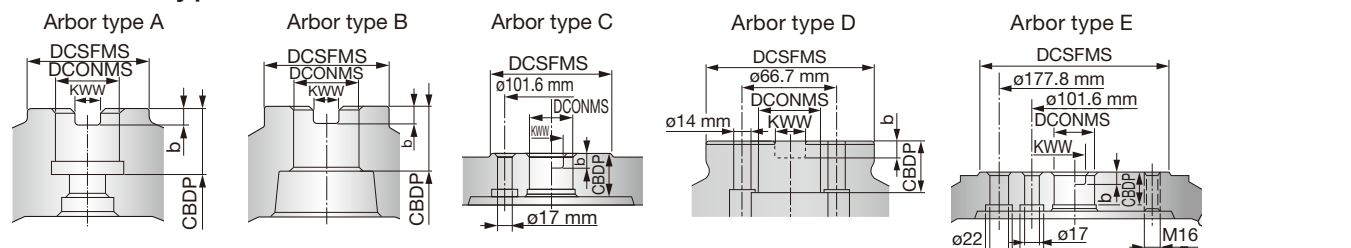

SPARE PARTS

Designation	Clamping screw	Grip	Shell locking bolt 1	Shell locking bolt 2	Torx bit
TAN07R063M22.0...	SRM5X0.8IP20X+ACROLYTE	H-TB	-	CM10X30H	BLDIP20/S7
TAN07R080M25.4...	SRM5X0.8IP20X+ACROLYTE	H-TB	-	CM12X30H	BLDIP20/S7
TAN07R100M31.7...	SRM5X0.8IP20X+ACROLYTE	H-TB	TMBA-M16H	-	BLDIP20/S7
TAN07R125M38.1...	SRM5X0.8IP20X+ACROLYTE	H-TB	TMBA-M20H	-	BLDIP20/S7
TAN07R160 - 315...	SRM5X0.8IP20X+ACROLYTE	H-TB	-	-	BLDIP20/M7

Recommended clamping torque: 7.5 N·m

Reference pages: Inserts → **H090**, Standard cutting conditions → **H091**

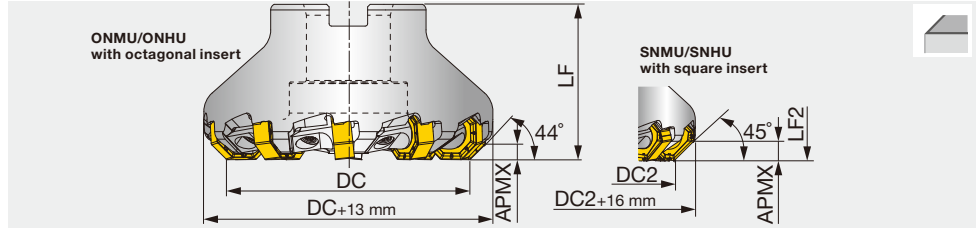

Designation	DC	DC2	CICT	DCSFMS	LF	LF2	DCONMS	CBDP	KWW	b	WT(kg)	Air hole	Insert	Arbor type
TAN07R063M22.0E08W	63	60.3	8	41	40	41.4	22	20	10.4	6.3	0.6	Without	SN*U/ON*U...	B
TAN07R080M25.4-10W	80	77.3	10	50	50	51.4	25.4	26	9.5	6	1	Without	SN*U/ON*U...	B
TAN07R080M27.0E10W	80	77.3	10	50	50	51.4	27	25	12.4	7	1.1	Without	SN*U/ON*U...	B
TAN07R100M31.7-14W	100	97.3	14	60	50	51.4	31.75	32	12.7	8	1.3	Without	SN*U/ON*U...	B
TAN07R100M32.0E14W	100	97.3	14	60	50	51.4	32	28.5	14.4	8	1.6	Without	SN*U/ON*U...	B
TAN07R125M38.1-18W	125	122.3	18	80	63	64.4	38.1	38	15.9	10	2.8	Without	SN*U/ON*U...	B
TAN07R125M40.0E18W	125	122.3	18	71	63	64.4	40	29	16.4	9	2.5	Without	SN*U/ON*U...	B
TAN07R160M50.8-22W	160	157.3	22	100	63	64.4	50.8	38	19	11	4	Without	SN*U/ON*U...	B
TAN07R160M40.0E22W	160	157.3	22	100	63	64.4	40	29	16.4	9	3.6	Without	SN*U/ON*U...	D
TAN07R200M60.0E28W	200	197.3	28	135	63	64.4	60	39	25.7	14	5.8	Without	SN*U/ON*U...	C

OWMT insert cannot be used with a wedge clamp type cutter.

Arbor type

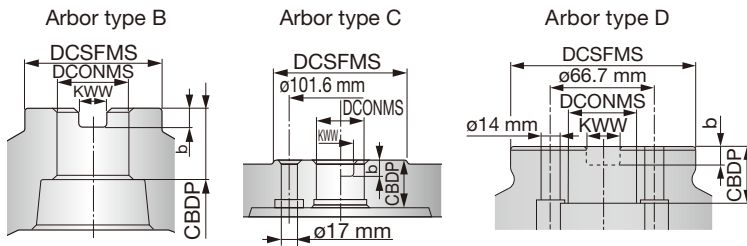

SPARE PARTS

Designation	Grip	Wedge	Wedge fixing screw	Torx bit
TAN07-W	H-TBS	CLARM-10-TUNG1	DS-6P	BLDIP15/S7

- High Feed Milling
- Face Milling
- Shoulder Milling
- Slot Milling
- Profile Milling
- Chamfering, Counterbore
- Finish Face Milling

INSERT

ONMU/ONHU0705-MJ / -ML

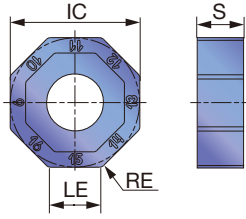

ONHU0705-W

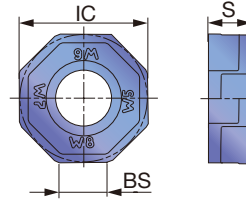

SNMU/SNHU1706 -MJ / -ML

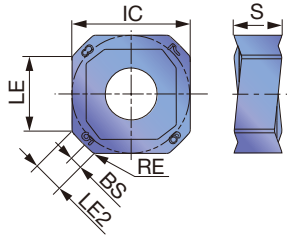

SNHU1706-W

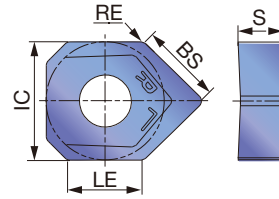

OWMT0807-ML

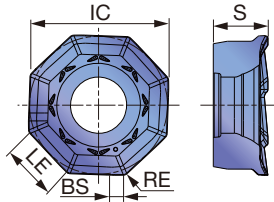

OWMT0807-HJ

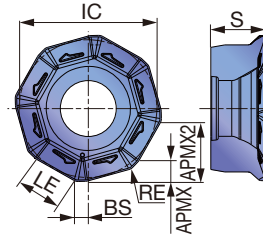

P	Steel			☆	★	★			★											
M	Stainless		☆			★														
K	Cast iron	★			☆				★											
N	Non-ferrous																			
S	Superalloys		☆			☆														
H	Hard materials					☆														

★ : First choice
☆ : Second choice

Designation	RE	APMX	Coated							LE	S	LE2	IC	BS	APMX2							
			AH120	AH130	AH140	AH725	AH3135	T1115	T1215							T3225						
ONMU0705ANPN-MJ	0.8	4.75			●	●	●	●	●	●							7.2	6.2	-	17.3	-	-
ONHU0705ANPN-MJ	0.8	4.75			●	●											7.2	6.2	-	17.3	-	-
ONMU0705ANPN-ML	0.8	4.75	●					●									7.2	6.2	-	17.3	-	-
ONHU0705ANTN-ML	0.8	4.75	●		●	●											7.2	6.2	-	17.3	-	-
ONHU0705ANPR-W *	-	4.75	●														7.2	5.8	-	17.5	6.4	-
OWMT0807ZNER-HJ	1.2	1.5						●									-	7.4	-	19	1	7.5
OWMT0807AAER-ML	0.8	3.5		●				●									5.2	7.4	-	18.9	1.2	-
SNMU1706ANPR-MJ	0.8	7.5			●	●	●			●	●						11	6.98	4.4	17.3	1.8	-
SNHU1706ANPR-MJ	0.8	7.5			●	●											11	6.98	4.4	17.3	1.8	-
SNMU1706ANTR-ML	0.8	7.5	●					●									11	6.98	4.4	17.3	1.8	-
SNHU1706ANTR-ML	0.8	7.5	●														11	6.98	4.4	17.3	1.8	-
SNHU1706ANFN-W *	0.4	7.5	●														17.3	6.5	-	17.3	11	-

* Pay attention to the wiper insert installation procedure below.

●: Line up

Attention for wiper inserts

ONHU0705ANPR-W

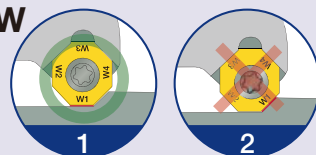

Attach only one wiper insert on the cutter and make sure the wiper edge faces the machining surface.
Feed rate: $f < 5.5$ mm/rev

SNHU1706ANFN-W

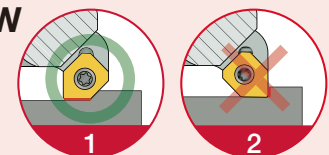

Attach only one wiper insert on the cutter and make sure the wiper edge faces the machining surface.
Feed rate: $f < 9.5$ mm/rev

STANDARD CUTTING CONDITIONS

Negative type

ISO	Workpiece material	Hardness	Priority	Recommendation		Cutting speed Vc (m/min)	Feed per tooth fz (mm/t)
				Grade	Chipbreaker		
P	Low carbon steel S15C, SS400, etc. C15E4, E275A, etc.	- 200 HB	First choice	AH3135	MJ	100 - 250	0.2 - 0.5
		- 200 HB	Wear resistance	T3225	MJ	200 - 350	0.2 - 0.4
		- 200 HB	Low cutting force	AH3135	ML	100 - 250	0.2 - 0.4
	High carbon steel S45C, S55C, etc. C45, C55, etc.	200 - 300 HB	First choice	AH3135	MJ	100 - 230	0.2 - 0.4
		200 - 300 HB	Wear resistance	T3225	MJ	180 - 300	0.2 - 0.4
		200 - 300 HB	Low cutting force	AH3135	ML	100 - 230	0.2 - 0.4
	Alloy steel SCM440, SCr415, etc. 42CrMo4, 17Cr3, etc.	150 - 330 HB	First choice	AH3135	MJ	100 - 200	0.2 - 0.4
		150 - 330 HB	Wear resistance	T3225	MJ	150 - 250	0.2 - 0.4
		150 - 330 HB	Low cutting force	AH3135	ML	100 - 200	0.2 - 0.4
M	Stainless steel SUS304, etc. X5CrNi18-9, etc.	- 200 HB	First choice	AH3135	MJ	100 - 200	0.1 - 0.3
		- 200 HB	Wear resistance	T3225	MJ	100 - 250	0.1 - 0.3
K	Grey cast iron FC350, FC450 etc. GG35, GG45, etc.	150 - 250 HB	First choice	T1215	MJ	150 - 300	0.1 - 0.5
		150 - 250 HB	Fracture resistance	AH725	MJ	100 - 250	0.1 - 0.5
		150 - 250 HB	Low cutting force	AH120	ML	100 - 250	0.1 - 0.5
	Ductile cast iron FCD600, etc. 600-3, etc.	150 - 300 HB	First choice	T1215	MJ	100 - 300	0.1 - 0.5
		150 - 300 HB	Fracture resistance	AH725	MJ	80 - 200	0.1 - 0.5
		150 - 300 HB	Low cutting force	AH120	ML	80 - 200	0.1 - 0.5
H	Hardened steel	40 - 50 HRC	First choice	AH725	MJ	80 - 130	0.1 - 0.2
		50 - 60 HRC	First choice	AH725	MJ	50 - 70	0.05 - 0.1

Positive type

ISO	Workpiece material	Hardness	Priority	Grade	Cutting speed Vc (m/min)	Feed per tooth : fz (mm/t)	
						ML	HJ*
P	Low carbon steel S15C, SS400, etc. C15E, etc.	- 200 HB	First choice	AH3135	100 - 300	0.1 - 0.4	0.5 - 1.5
		- 200 HB	Fracture resistance	AH130	100 - 300	0.1 - 0.4	-
	High carbon steel S45C, S55C, etc. C45, C55, etc.	200 - 300 HB	First choice	AH3135	100 - 230	0.1 - 0.3	0.5 - 1.5
		200 - 300 HB	Fracture resistance	AH130	100 - 230	0.1 - 0.3	-
M	Alloy steel SCM440, SCr415, etc. 42CrMo4, 17Cr3, etc.	150 - 330 HB	First choice	AH3135	100 - 200	0.1 - 0.3	0.5 - 1.5
		150 - 330 HB	Fracture resistance	AH130	100 - 200	0.1 - 0.3	-
K	Stainless steel SUS304, etc. X5CrNi18-9, etc.	- 200 HB	First choice	AH3135	100 - 150	0.1 - 0.3	0.3 - 0.7
		- 200 HB	Fracture resistance	AH130	100 - 150	0.1 - 0.3	-
K	Grey cast iron FC350, FC450 etc. GG35, GG45, etc.	150 - 250 HB	First choice	AH3135	100 - 250	0.1 - 0.4	0.5 - 1.5
		150 - 250 HB	Fracture resistance	AH130	100 - 250	0.1 - 0.4	-
	Ductile cast iron FCD600, etc. 600-3, etc.	150 - 250 HB	First choice	AH3135	80 - 200	0.1 - 0.3	0.5 - 1.5
		150 - 250 HB	Fracture resistance	AH130	80 - 200	0.1 - 0.3	-
S	Titanium alloy Ti-6Al-4V, etc.	- HRC 40	First choice	AH3135	30 - 60	0.1 - 0.3	0.3 - 0.7
		- HRC 40	Fracture resistance	AH130	30 - 60	0.1 - 0.3	-
	Heat resistant alloy Inconel718, etc.	- HRC 40	First choice	AH3135	10 - 40	0.05 - 0.15	0.1 - 0.3
		- HRC 40	Fracture resistance	AH130	10 - 40	0.05 - 0.15	-
H	Hardened steel	40 - 50 HRC	First choice	AH3135	80 - 130	-	0.1 - 0.3
		50 - 60 HRC	First choice	AH3135	50 - 70	-	0.03 - 0.07

* Apply 20% of recommended feed when using HJ insert with ap over 1.5 mm.

Grade
Insert
Ext. Toolholder
Int. Toolholder
Threading
Grooving
Miniature tool
Milling cutter
Endmill
Drilling tool
Tooling System
User's Guide
Index





TUNGSPRILL

EPYD06



Face milling cutter for non-ferrous applications, shank type, with PCD inserts

GAMP = +9°, GAMF = +4°

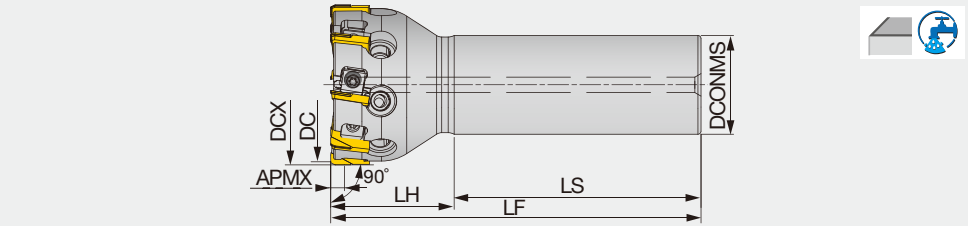

Designation	APMX	DC	DCX	CICT	DCONMS	LF	LH	LS	WT(kg)	Air hole	RPMX(min ⁻¹)	Insert
EPYD06M050C32.0R06	4.5	50	52	6	32	120	40	80	0.91	With	20,000	YDEN0603...
EPYD06M050C32.0R08	4.5	50	52	8	32	120	40	80	0.9	With	20,000	YDEN0603...



TPYD06

Face milling cutter for non-ferrous applications, bore type, with PCD inserts

GAMP = +9°, GAMF = +4°

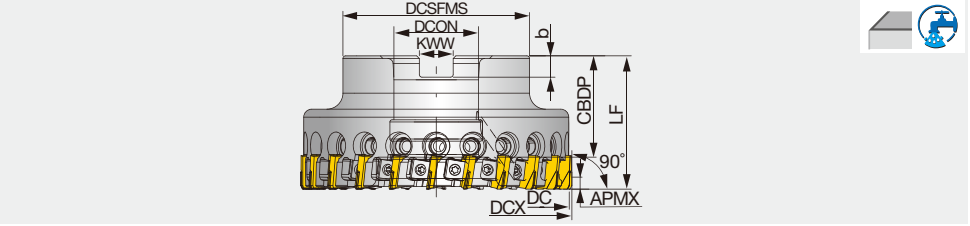

Designation	APMX	DC	DCX	CICT	DCSFMS	LF	DCON	CBDBP	KWW	b	WT(kg)	Air hole	RPMX(min ⁻¹)	Insert
TPYD06M063B22.0R08	4.5	63	65	8	45	40	22	20	10.4	6.3	0.59	With	19,000	YDEN0603...
TPYD06M063B22.0R10	4.5	63	65	10	45	40	22	20	10.4	6.3	0.57	With	19,000	YDEN0603...
TPYD06M080B27.0R10	4.5	80	82	10	60	50	27	22	12.4	7	1.3	With	17,000	YDEN0603...
TPYD06M080B27.0R16	4.5	80	82	16	60	50	27	22	12.4	7	1.24	With	17,000	YDEN0603...
TPYD06J080B25.4R10	4.5	80	82	10	60	50	25.4	26	9.5	6	1.31	With	17,000	YDEN0603...
TPYD06J080B25.4R16	4.5	80	82	16	60	50	25.4	26	9.5	6	1.26	With	17,000	YDEN0603...
TPYD06M100B32.0R12	4.5	100	102	12	70	50	32	25	14.4	8	1.85	With	15,000	YDEN0603...
TPYD06M100B32.0R22	4.5	100	102	22	70	50	32	25	14.4	8	1.78	With	15,000	YDEN0603...
TPYD06J100B31.7R12	4.5	100	102	12	70	50	31.75	32	12.7	8	1.84	With	15,000	YDEN0603...
TPYD06J100B31.7R22	4.5	100	102	22	70	50	31.75	32	12.7	8	1.76	With	15,000	YDEN0603...
TPYD06M125B40.0R14	4.5	125	127	14	90	60	40	32	16.4	9	3.59	With	14,000	YDEN0603...
TPYD06M125B40.0R26	4.5	125	127	26	90	60	40	32	16.4	9	3.48	With	14,000	YDEN0603...
TPYD06J125B38.1R14	4.5	125	127	14	90	60	38.1	38	15.9	10	3.61	With	14,000	YDEN0603...
TPYD06J125B38.1R26	4.5	125	127	26	90	60	38.1	38	15.9	10	3.56	With	14,000	YDEN0603...
TPYD06M160B40.0R20	4.5	160	162	20	90	60	40	32	16.4	9	5.34	With	12,000	YDEN0603...
TPYD06M160B40.0R34	4.5	160	162	34	90	60	40	32	16.4	9	5.2	With	12,000	YDEN0603...
TPYD06J160B38.1R20	4.5	160	162	20	90	60	38.1	38	15.9	10	5.43	With	12,000	YDEN0603...
TPYD06J160B38.1R34	4.5	160	162	34	90	60	38.1	38	15.9	10	5.29	With	12,000	YDEN0603...



SPARE PARTS



Designation	Insert locking wedge	Wedge fixing screw	Adjusting cam	Torx bit	Cam tightening screw	Wrench	Grip	Shell locking bolt
EPYD06M050C32.0R**	WF875N	DS-5T	AJC08	BLDT10/S7-A	SSHM4-4	P-2	H-TB2W	-
TPYD06M063B22.0R**	WF875N	DS-5T	AJC08	BLDT10/S7-A	SSHM4-4	P-2	H-TB2W	CM10x30H
TPYD06*080B2*.R**	WF875N	DS-5T	AJC08	BLDT10/S7-A	SSHM4-4	P-2	H-TB2W	CM12x30H
TPYD06M100B32.0R**	WF875N	DS-5T	AJC08	BLDT10/S7-A	SSHM4-4	P-2	H-TB2W	CM16x40H
TPYD06J100B31.7R**	WF875N	DS-5T	AJC08	BLDT10/S7-A	SSHM4-4	P-2	H-TB2W	TMBA-M16H
TPYD06*125B**.R**	WF875N	DS-5T	AJC08	BLDT10/S7-A	SSHM4-4	P-2	H-TB2W	TMBA-M20H
TPYD06*160B**.R**	WF875N	DS-5T	AJC08	BLDT10/S7-A	SSHM4-4	P-2	H-TB2W	TMBA-M20H

INSERT

YDEN0603PD(F/S)R-D

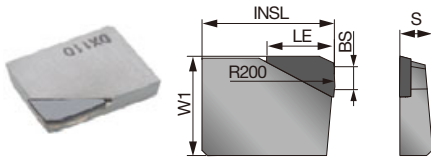

YDEN0603PDFR-WD

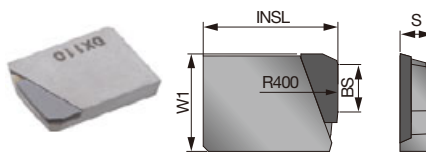

YDEN0603PDFR-BD

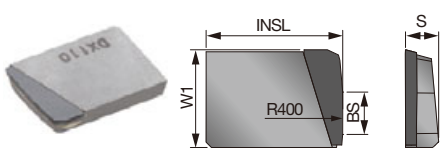

YDEN0603PDCR-LD

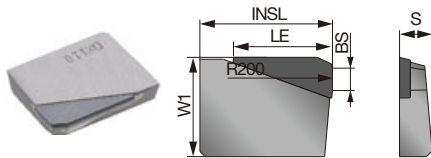

YDEN0603(04/08)PDFR-D

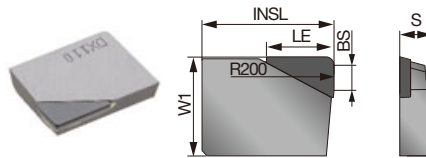

P	Steel									
M	Stainless									
K	Cast iron									
N	Non-ferrous	★								
S	Superalloys									
H	Hard materials									

★ : First choice

Designation	APMX	Edge prep.	PCD										
			DX110										
			W1	INSL	S	BS	LE						
YDEN0603PDFR-D	4.5	Without	●						9.5	12.7	3.1	2.2	6.5
YDEN0603PDSR-D	4.5	With	●						9.5	12.7	3.1	2.2	6.5
YDEN060304PDFR-D	4.5	Without	●						9.5	12.7	3.1	2.8	6.5
YDEN060308PDFR-D	4.5	Without	●						9.5	12.7	3.1	2.4	6.5
YDEN0603PDCR-LD	7.5	With*	●						9.5	12.7	3.1	2.2	9.5
YDEN0603PDFR-WD	-	Without	●						9.2	12.8	3.1	4.5	-
YDEN0603PDFR-BD	-	Without	●						9.2	12.9	3.1	4	-

* Edge preparation is applied only on the peripheral and chamfered sections. The remaining section of the cutting edge is left sharp.

● : Line up
Package quantity = 1 pc. per box

STANDARD CUTTING CONDITIONS

ISO	Workpiece materials	Grades	Cutting speed Vc (m/min)	Feed per tooth fz (mm/t)
N	Cast aluminum alloy / Die-cast (Si < 13%)	DX110	500 - 4,000	0.05 - 0.2
	Cast aluminum alloy / Die-cast (Si ≥ 13%)	DX110	200 - 800	0.05 - 0.2
	Aluminum alloy (1000 - 7000 series)	DX110	500 - 4,000	0.05 - 0.2
	Copper alloy	DX110	200 - 500	0.05 - 0.2

- The values in the above list are of standard recommendations and may require adjustments in consideration with cutting depths and/or workpiece/machine rigidity.
- Use wiper inserts (-WD) for better surface requirements and deburring inserts (-BD) to remove burrs.
- Always use wet cutting (emulsion coolant) for machining aluminum or copper alloys.
- To make the best of the cutter's deburring ability, make sure to place a deburring insert immediately behind every standard insert on the cutter.





High Feed Milling

TUNGSPRILL TPYP12



Face Milling

High speed PCD mill for non ferrous metal



Shoulder Milling

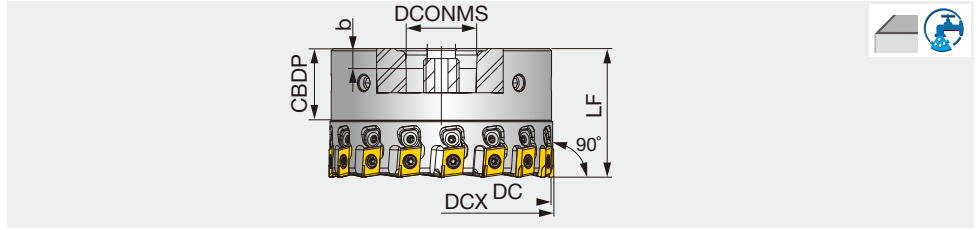

Slot Milling



Profile Milling



Chamfering, Counterbore



Finish Face Milling

Designation	DC	DCX	CICT	LF	DCONMS	CBDP	KWW	b	WT(kg)	Air hole	Insert
TPYP12M050B22.0R08	50	51.4	8	55	22	20	10.4	6.3	0.9	With	YPEB12X3-*P...
TPYP12M063B22.0R10	63	64.4	10	55	22	20	10.4	6.3	1.3	With	YPEB12X3-*A...
TPYP12M080B27.0R12	80	81.4	12	58	27	22	12.4	7	2.2	With	YPEB12X3-*A...
TPYP12J080B25.4R12	80	81.4	12	58	25.4	26	9.5	6	2.2	With	YPEB12X3-*A...
TPYP12M100B32.0R16	100	101.4	16	58	32	25	14.4	8	1.9	With	YPEB12X3-*A...
TPYP12J100B31.7R16	100	101.4	16	58	31.75	32	12.7	8	1.9	With	YPEB12X3-*A...
TPYP12M125B40.0R20	125	126.4	20	58	40	28	16.4	9	2.9	With	YPEB12X3-*A...
TPYP12J125B38.1R20	125	126.4	20	58	38.1	38	15.9	10	2.9	With	YPEB12X3-*A...

DCX: Outside diameter
DC: Diameter with 01 type insert

SPARE PARTS

Designation	Clamping screw	Wrench	Wedge fixing screw	Wedge	Wrench	Cover	Shell locking bolt
TPYP12M050B22.0R08	VX040024A	T-15F	RSRGR7M40	RSFTC1008	T-8F	-	RSFTS-050M
TPYP12M063B22.0R10	VX040024A	T-15F	RSRGR7M40	RSFTC1008	T-8F	RSFTS6063M	VC004762110035F
TPYP12M080B27.0R12, TPYP12J080B25.4R12	VX040024A	T-15F	RSRGR7M40	RSFTC1008	T-8F	RSFTS6080	VC00TED112040F
TPYP12M100B32.0R16, TPYP12J100B31.7R16	VX040024A	T-15F	RSRGR7M40	RSFTC1008	T-8F	RSFTS6100	VC00TANG16040F
TPYP12M125B40.0R20, TPYP12J125B38.1R20	VX040024A	T-15F	RSRGR7M40	RSFTC1008	T-8F	RSFTS6125	VC00TED120040F

Recommended clamping torque: 4.5 N·m

Approach angle



Others

INSERT

YPEB12X3-1A

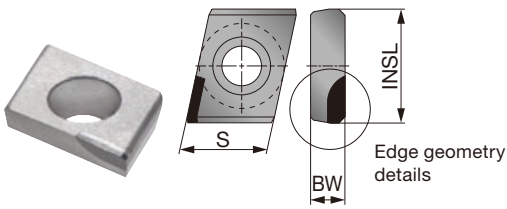

YPEB12X-FP

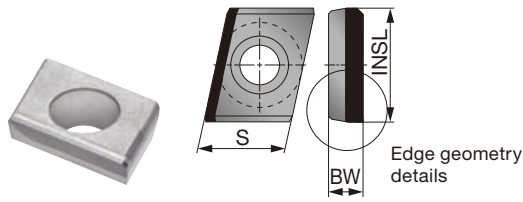

YPEB12X3-2A/P

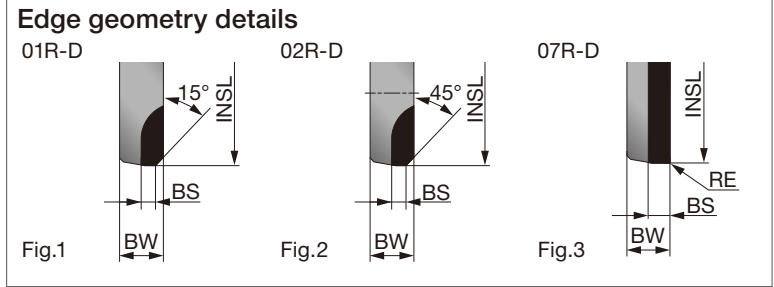
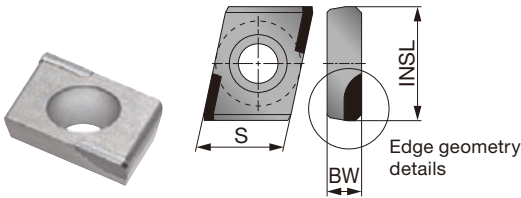

P	Steel		
M	Stainless		
K	Cast iron		
N	Non-ferrous	★	
S	Superalloys		
H	Hard materials		

★ : First choice
☆ : Second choice

Designation	No. of corner	RE	APMX	PCD				INSL	S	BW	BS	Applicable cutter diameter	Fig.
				DX160									
YPEB12X3-1A01R-D	1	-	4	●				12.77	9.525	3.85	1.59	DC > ø50 mm	1
YPEB12X3-1A02R-D	1	-	4	●				12.756	9.525	3.85	1.29	DC > ø50 mm	2
YPEB12X3-1A07R-D	1	0.4	4	●				12.756	9.525	3.85	1.34	DC > ø50 mm	3
YPEB12X3-1P02R-D	1	-	4	●				12.817	9.525	3.85	1.37	DC ≤ ø50 mm	2
YPEB12X3-1P07R-D	1	0.4	4	●				12.817	9.525	3.85	1.37	DC ≤ ø50 mm	3
YPEB12X3-FP02R-D	1	-	11	●				12.817	9.525	3.85	1.37	DC ≤ ø50 mm	2
YPEB12X3-FP07R-D	1	0.4	11	●				12.817	9.525	3.85	1.37	DC ≤ ø50 mm	3
YPEB12X3-2A01R-D	2	-	4	●				12.8	9.525	3.868	1.59	DC > ø50 mm	1
YPEB12X3-2A02R-D	2	-	4	●				12.8	9.525	3.868	2.07	DC > ø50 mm	2
YPEB12X3-2A07R-D	2	0.4	4	●				12.8	9.525	3.868	2.07	DC > ø50 mm	3
YPEB12X3-2P07R-D	2	0.4	4	●				12.876	9.525	3.85	2.07	DC ≤ ø50 mm	3

● : Line up
2 pieces per package

STANDARD CUTTING CONDITIONS

ISO	Workpiece material	Grade	Cutting speed Vc (m/min)	Feed per tooth fz (mm/z)
N	Aluminum cast Si < 13%	DX160	≤ 6000	0.05 - 0.25
	Aluminum cast Si ≥ 13%	DX160	≤ 1500	0.05 - 0.25
	Copper, brass, etc.	DX160	≤ 2000	0.05 - 0.25
	Non metallic material	DX160	≤ 3000	0.05 - 0.25



EFE / TFE

EFE12R

Face endmill for aluminium machining, shank type, with screw clamp system

GAMP = +13°, GAMF = +7°

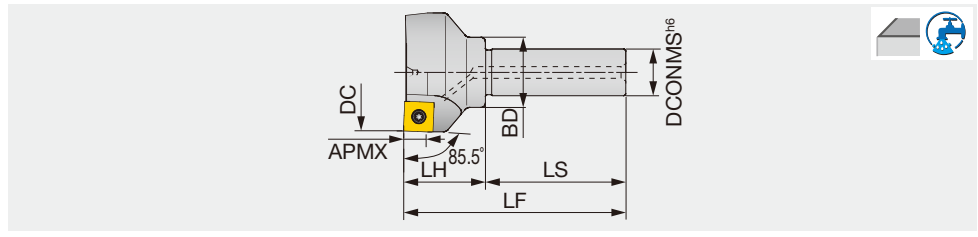

Designation	APMX	DC	CICT	DCONMS	BD	LS	LH	LF	WT(kg)	Air hole	Insert
EFE12050R	8	50	3	20	30	60	35	95	0.37	With	SEG*12X4...



TFE12R

Face mill for aluminium machining, with screw clamp system, light weight

GAMP = +13°, GAMF = +7°

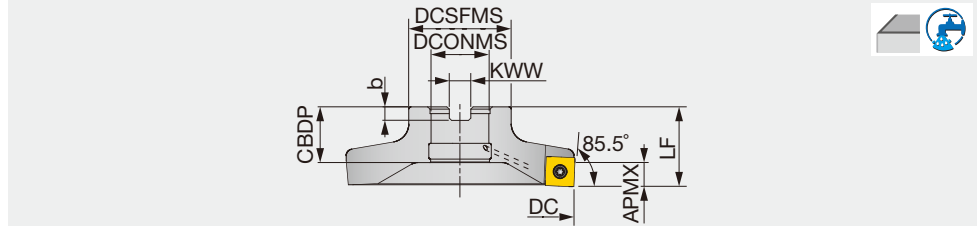

Designation	APMX	DC	CICT	DCSFMS	LF	DCONMS	CBDP	KWW	b	WT(kg)	Air hole	Insert
TFE12063R	8	63	3	45	35	22	19	10	6	0.34	With	SEG*12X4...
TFE12080R	8	80	4	50	35	25.4	24.5	9.5	6	0.45	With	SEG*12X4...
TFE12100R	8	100	6	50	35	25.4	24.5	9.5	6	0.59	With	SEG*12X4...
TFE12125R	8	125	6	50	35	25.4	24.5	9.5	6	0.9	With	SEG*12X4...



TFE12R...-...A

Face mill for aluminium machining, with screw clamp system

GAMP = +13°, GAMF = +7°

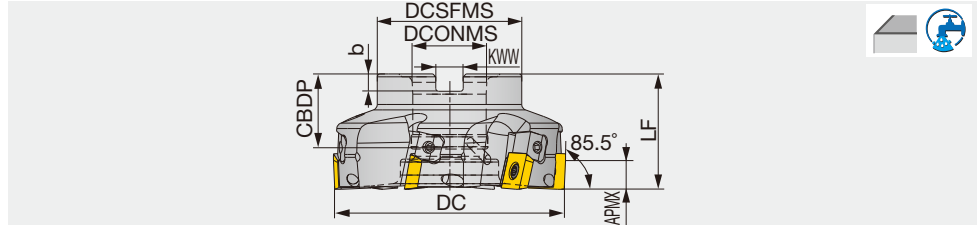
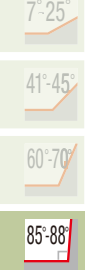

Designation	APMX	DC	CICT	DCSFMS	LF	DCONMS	CBDP	KWW	b	WT(kg)	Air hole	Insert
TFE12R080M25.4-06A	8	80	6	50	40	25.4	26	9.5	6	0.70	With	SEG*12X4...
TFE12R080M27.0E06A	8	80	6	55	40	27	22	12.4	7	0.69	With	SEG*12X4...
TFE12R100M25.4-08A	8	100	8	50	40	25.4	26	9.5	6	1.15	With	SEG*12X4...
TFE12R100M27.0E08A	8	100	8	55	40	27	22	12.4	7	1.11	With	SEG*12X4...
TFE12R125M31.7-10A	8	125	10	70	50	31.7	32	12.7	8	2.24	With	SEG*12X4...
TFE12R125M32.0E10A	8	125	10	70	50	32	28.5	14.4	8	2.14	With	SEG*12X4...

SPARE PARTS



Designation	Clamping screw	Adjustable Wedge	Lubricant	Shell locking bolt 1	Shell locking bolt 2	Right-left screw	Wrench	Wrench
EFE12000R	CSPB-4S	-	M-1000	-	-	-	-	IP-15D
TFE12063R	CSPB-4S	-	M-1000	-	CM10X30H	-	-	IP-15D
TFE12080R - TFE12125R	CSPB-4S	-	M-1000	TMBA-M12H	-	-	-	IP-15D
TFE12R**A	CSTB-4	FW-701R	M-1000	TMBA-M12H	-	MCS520-2.5	P-2.5T	T-15LB

Recommended clamping torque: 3.5 N·m

Reference pages: Inserts → **H098**, Standard cutting conditions → **H099**

INSERT SETTING PROCEDURE – ADJUSTABLE-TYPE TFE FACE MILLING CUTTER

1 Cleaning insert pockets



Remove all the inserts. Use air pressure to thoroughly clean the pockets of dust and chips.

2 Loosening wedges



CCW rotation
- Insert screw loosens
- Wedge slides out
- Insert lowers

CW rotation
- Insert screw tightens
- Wedge slides in
- Insert lifts up

Use the included key for wedge adjustment to loosen all the wedges so that they do not exceed the cutter's outer diameter.

3 Clamping inserts for adjustments

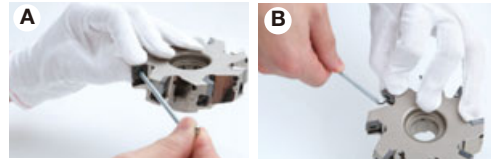

Place the insert in the pocket and lightly tighten the clamping screw with the included key. Suggested method: Tighten the screw first with the straight end of the key (Fig A) until finger tight, then use the angled end to further tighten the screw for insert steadiness (Fig B). Do NOT fully tighten the screw at this moment as this procedure is prior to insert adjustment. Repeat the procedure for all inserts.

4 Axial height adjustment of inserts



Mount the cutter in Step ③ on the setting fixture of the pre-setter. Determine the highest insert, and, while carefully monitoring each insert's axial position, rotate the wedge screw in the CW direction to raise the insert in the axial direction, as close as possible to that of the highest insert. Repeat this procedure for all inserts.

Note:
Since the insert is clamped, loosening the wedge screw will not bring down the insert. To lower insert height, both the insert and wedge screws need to be loosened. Start the adjusting procedure for this insert again from Step 1.

5 Tighten insert screws



Tighten the insert clamping screw at 3.5 Nm, using the key as shown to the left. Repeat the procedure for all inserts.

6 Final adjustments



After final tightening of all insert screws, measure to ensure all inserts are at the desired axial heights. If necessary, further tighten any wedge screws in the CW direction for the final few microns. For inserts exceeding the required runout, re-start the adjustment procedure from Step ①.

Note:
Do not re-tighten the insert screw after insert adjustment is completed. Additional tightening may weaken wedge clamping torque.

Cautions:

- ① Always clean all the insert pockets thoroughly of dust and chips. Any objects present in the pocket may shift the insert's position during machining and cause poor surface finishing quality.
- ② Always loosen the wedge screw before installing the insert as described in Step ②. If the wedge is left tightened in the cutter, the adjustment range of the wedge will be limited, and insert height may not be as freely adjustable as possible.
- ③ With a finger, firmly press and hold the insert into the wedge while tightening the insert screw. If the insert is not in contact, the wedge has to be driven until the gap in between is closed, with no actual insert movement.
- ④ Loosening the wedge will not lower the insert. When the insert height exceeds the desired setting during adjustment, loosen both the insert and wedge screws and re-start the adjustment procedure from Step ①. If the insert slides downward when the wedge screw is loosened, the clamping torque of the insert screw is too low. Tighten the insert screw with a slightly higher torque. Suggested clamping method: First use the straight end of the key to tighten the screw until finger tight, then switch the key to the angled side and turn an additional 45°.
- ⑤ Do not exceed the recommended clamping torque when fixing the insert. This may damage or fracture the insert screw.

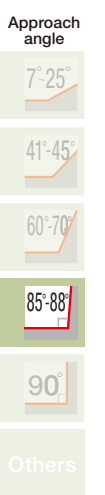

INSERT

SEGW12X4ZEPR / ZEFR

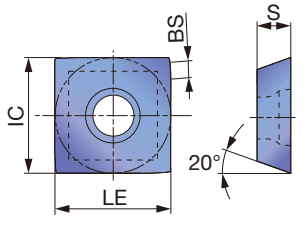

SEGT12X4-AJ

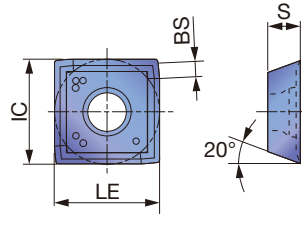

SEGW12X4ZEFR-D

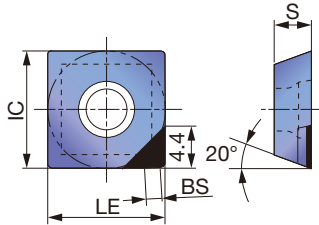

SEGW12X4ZEFR-WD

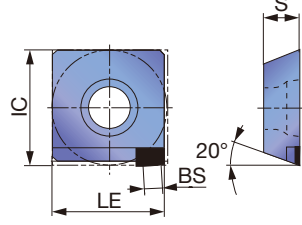

SEGW12X4ZEFR-BD

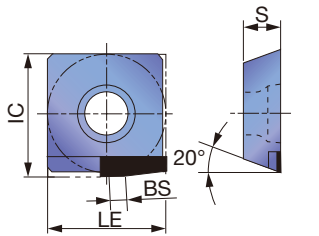

2QP-SECW12X412ZETR

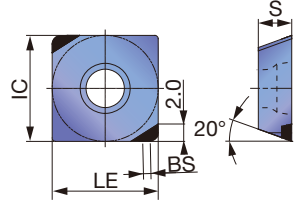

1QP-SECW12X4ZETR-W

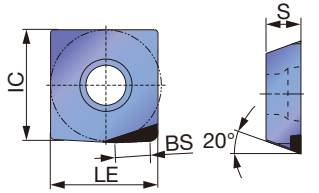

1QP-SECW12X4ZETR-B

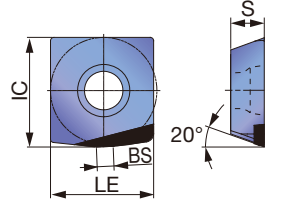

P Steel	★			★									
M Stainless		★											
K Cast iron	★								★				
N Non-ferrous			★		★	★							
S Superalloys													
H Hard materials													

★ : First choice

Designation	APMX	Coated			Cermet	Uncoated	PCD	CBN	IC	LE	S	BS
		AH120	AH140	DS1100	NS740	KS05F	DX140	BX480				
SEGW12X4ZEFR	8					●			12.7	12.7	4	1.8
SEGW12X4ZEPR	8	●	●		●				12.7	12.7	4	1.4
SEGT12X4ZEFR-AJ	8			●		●			12.7	12.7	4	1.8
SEGW12X4ZEFR-D	3.5						●		12.7	12.7	4	1.8
SEGW12X4ZEFR-WD	-						●		12.8	12.4	4	2
SEGW12X4ZEFR-BD	-						●		13.1	12.4	4	1.8
2QP-SECW12X412ZETR	1.5							●	12.7	12.7	4	0.9
1QP-SECW12X4ZETR-W	-							●	12.9	12.3	4	4
1QP-SECW12X4ZETR-B	-							●	13.1	12.3	4	2

● : Line up

DX140: 2 pieces per package
BX480: 1 piece per package

How to put each insert together

		For general	Accuracy of machining surface priority	Burr reduction priority
Applicable insert	General insert	SEGW12X4ZEFR-D DX140	◎	◎
		2QP-SECW12X412ZETR BX480		
	Wiper insert	SEGW12X4ZEFR-WD DX140	-	-
		1QP-SECW12X4ZETR-W BX480		
Wiper insert for burr reduction	SEGW12X4ZEFR-BD DX140	-	◎	
	1QP-SECW12X4ZETR-B BX480			
Number of Inserts by type		All general	1 or 2 wiper inserts in cutter body	General insert : Burr wiper insert = 1 : 1
Accuracy of machining surface (roughness and undulation)		△	◎	○
Burr of machining surface		△	○	◎

STANDARD CUTTING CONDITIONS

ISO	Workpiece material	Hardness	Grade	Designation	Cutting speed Vc (m/min)	Feed per tooth fz (mm/t)
P	Carbon steels and alloy steels	< 300HB	AH120	SEGW12X4ZEPR	100 - 180	0.03 - 0.15
		< 300HB	NS740	SEGW12X4ZEPR	100 - 180	0.03 - 0.15
M	Stainless steels	< 250HB	AH140	SEGW12X4ZEPR	80 - 180	0.03 - 0.15
K	Grey and ductile cast irons	150 - 250 HB	AH120	SEGW12X4ZEPR	100 - 200	0.03 - 0.15
	Grey cast iron	150 - 250 HB	BX480	2QP-SEC-W12X412ZETR	800 - 1500	0.05 - 0.3
	Ductile cast irons	150 - 250 HB	BX480	2QP-SEC-W12X412ZETR	500 - 800	0.05 - 0.2
N	Cast aluminium alloy / Die-cast Si < 13%	-	KS05F	SEGT12X4ZEFR-AJ	200 - 1500	0.05 - 0.2
		-	DX140	SEGW12X4ZEFR-D	200 - 1500	0.05 - 0.2
	Cast aluminium alloy / Die-cast Si ≥ 13%	-	KS05F	SEGT12X4ZEFR-AJ	80 - 200	0.05 - 0.2
		-	DX140	SEGW12X4ZEFR-D	200 - 500	0.05 - 0.2
	Aluminium alloy Tensile strength < 350 N/mm ²	-	KS05F	SEGT12X4ZEFR-AJ	200 - 1500	0.05 - 0.2
		-	DX140	SEGW12X4ZEFR-D	200 - 1500	0.05 - 0.2
Aluminium alloy Tensile strength > 350 N/mm ²	-	KS05F	SEGW12X4ZEFR	200 - 1500	0.05 - 0.2	
	-	DX140	SEGW12X4ZEFR-D	200 - 1500	0.05 - 0.2	
Copper alloy	-	KS05F	SEGT12X4ZEFR-AJ	200 - 500	0.05 - 0.2	
	-	DX140	SEGW12X4ZEFR-D	200 - 500	0.05 - 0.2	

Notes:

- In milling aluminium and copper alloys:
 - For improved surface finish, use together with wiper insert SEGW12X4ZEFR-WD
 - For reducing burr occurrence, use together with deburring inserts SEGW12X4ZEFR-BD
- When milling aluminium and copper alloys, use of a water soluble cutting fluid is recommended. When milling steels, cast irons, and stainless steels, dry cutting is recommended.
- When the length-to-diameter overhang ratio of the tool (L/D) exceeds 3, reduce cutting speed and feed to 70 to 80% of the values given in the table.



EDPD / DPD

EDPD09

Endmill for aluminium machining, shank type, for PCD inserts

GAMP = +8.5°, GAMF = +3°

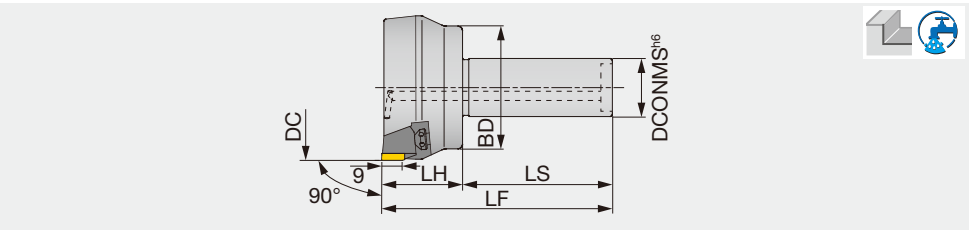

Designation	APMX	DC	CICT	DCONMS	BD	LS	LH	LF	WT(kg)	Air hole	Insert
EDPD09063R	7	63	3	25	37	60	40	100	0.75	With	YDEN0905...

DPD09

Face mill for aluminium machining, for PCD inserts

GAMP = +8.5°, GAMF = +3° ~ +5°

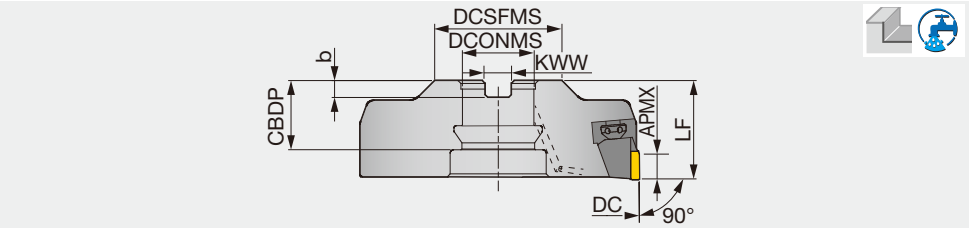

Designation	APMX	DC	CICT	DCSFMS	LF	DCONMS	CDBP	KWW	b	WT(kg)	Air hole	Insert
DPD09080R	7	80	4	50	41	25.4	23	9.5	6	0.8	With	YDEN0905...
DPD09080RB	7	80	6	50	41	25.4	28.5	9.5	6	0.82	With	YDEN0905...
DPD09100R	7	100	6	50	35	25.4	24.5	9.5	6	1.13	With	YDEN0905...
DPD09100RB	7	100	8	50	35	25.4	24.5	9.5	6	1.17	With	YDEN0905...
DPD09125R	7	125	6	50	35	25.4	24.5	9.5	6	1.7	With	YDEN0905...
DPD09125RB	7	125	10	50	35	25.4	24.5	9.5	6	1.77	With	YDEN0905...
DPD09160R	7	160	8	60	52	31.75	40	12.7	8	3.28	With	YDEN0905...
DPD09160RB	7	160	12	60	52	31.75	40	12.7	8	3.25	With	YDEN0905...

SPARE PARTS

Designation	Clamping screw	Wedge fixing screw	Adjusting screw	Helisert	Shell locking bolt 1	Shell locking bolt 2	Wrench1	Wrench 2
EDPD09063R	EDPD09063R	FDS-8SST	AJM5	LM5-0.8X1DNS	-	-	T-27T	T-7F
DPD09080R*	FW-304R-T	FDS-8ST-18	AJM5	LM5-0.8X1DNS	-	CM12X30H	T-27T	T-7F
DPD09100R*, DPD09125R*	FW-304R-T	FDS-8ST-18	AJM5	LM5-0.8X1DNS	TMBA-M12H	-	T-27T	T-7F
DPD09160R*	FW-304R-T	FDS-8ST-18	AJM5	LM5-0.8X1DNS	TMBA-M16H	-	T-27T	T-7F

Recommended clamping torque: 10 N·m

INSERT

YDEN0905PDFR-D

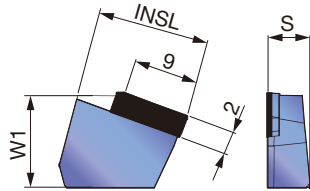

YDEN0905PDFR-WD

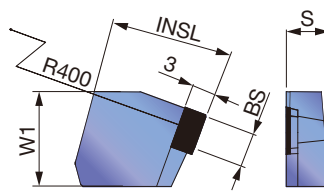

YDEN0905PDFR-BD

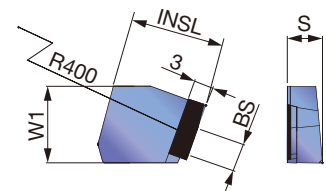

P	Steel
M	Stainless
K	Cast iron
N	Non-ferrous
S	Superalloys
H	Hard materials

★ : First choice
☆ : Second choice

Designation	APMX	PCD								W1	INSL	S	BS
		DX140											
YDEN0905PDFR-D	7	●								12.4	15.1	5.7	-
YDEN0905PDFR-WD	-	●								12.4	15.2	5.7	4.5
YDEN0905PDFR-BD	-	●								12.4	15.2	5.7	4.5

Tungaloy provides refurbishing service for these inserts upon request.

● : Line up
1 piece per package

STANDARD CUTTING CONDITIONS

ISO	Workpiece material	Grade	Designation	Cutting speed Vc (m/min)	Feed per tooth fz (mm/t)
N	Aluminium alloy castings & die castings Si < 13%	DX140	YDEN0905PDFR-D	500 ~ 4000	0.05 ~ 0.2
	Aluminium alloy castings & die castings Si ≥ 13%	DX140	YDEN0905PDFR-D	200 ~ 500	0.05 ~ 0.2
	Rolled aluminium alloys	DX140	YDEN0905PDFR-D	500 ~ 4000	0.05 ~ 0.2
	Copper alloys	DX140	YDEN0905PDFR-D	200 ~ 500	0.05 ~ 0.2

Notes:

- When requiring improved surface finish, use the wiper insert together with regular inserts YDEN0905PDFR-WD.
- When requiring reduced burr occurrence, use the deburring inserts together with regular inserts YDEN0905PDFR-BD.
- When using the cutter at speeds over 1500m/min, use an arbor or tool-holder balanced to within G16.
- Wet cutting, using a water soluble cutting fluid, is recommended.
- When the length-to-diameter overhang ratio of the tool (L/D) exceeds 3, reduce cutting speed and feed to 70 to 80% of the values given in the table.

How to put each insert together

		For general	Accuracy of machining surface priority	Burr reduction priority
Applicable insert	General insert YDEN0905PDFR-D	◎	◎	◎
	Wiper insert YDEN0905PDFR-WD	-	◎	-
	Wiper insert for burr reduction YDEN0905PDFR-BD	-	-	◎
Number of Inserts by type		All general	1 or 2 wiper inserts in cutter body	General insert : Burr wiper insert = 1 : 1
Specification of insert setting				
Accuracy of machining surface (roughness and undulation)		△	◎	○
Burr of machining surface		△	○	◎



CERAMIC^{SPEED} MILL TFMRN

Face milling cutter for high temperature alloy applications

GAMP = -7°, GAMF = +15°

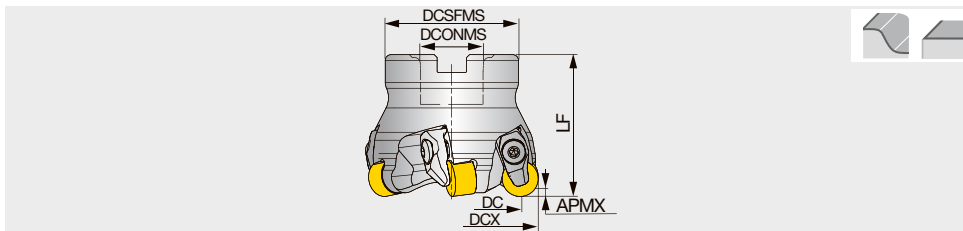

Designation	APMX	DC	DCX	CICT	DCONMS	LF	DCSFMS	WT(kg)	Insert
TFMRN563-22R-12FL	2	50.35	63	5	22	50	47	0.6	RNGN120700...
TFMRN580-27R-12FL	2	67.34	80	5	27	50	58	0.9	RNGN120700...

SPARE PARTS

Designation	Clamp	Screw	Snap ring
TFMRN**-**R-12FL	CCL-5S-F	CLS3C	CSR2

INSERT

RNGN-E/T1

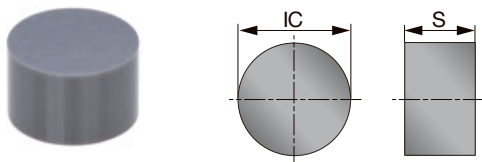

P Steel						
M Stainless						
K Cast iron						
N Non-ferrous						
S Superalloys	★	★				
H Hard materials						

★ : First choice

Designation	APMX	Edge prep.*	Ceramic		IC	S
			TS200	TS300		
RNGN120700-E	2	E	●		12.7	7.94
RNGN120700-T1	2	T1	●		12.7	7.94
RNGN120700-E	2	E		●	12.7	7.94
RNGN120700-T1	2	T1		●	12.7	7.94

* Types of cutting edge preparations

●: Line up

Edge prep

E: Low cutting force

T1: Strong cutting edge

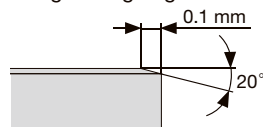
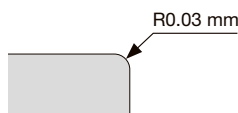

STANDARD CUTTING CONDITIONS

ISO	Workpiece materials	Priority	Grades	Cutting speed Vc (m/min)	Feed per tooth fz (mm/t)	Depth of cut ap(mm)
S	Ni-based super alloys	Wear resistance	TS200	550 - 1300	0.05 - 0.2	0.1 - 2
		First choice	TS300	270 - 550	0.05 - 0.2	0.1 - 2
	Co-based super alloys	Wear resistance	TS200	550 - 1500	0.05 - 0.2	0.1 - 2
		First choice	TS300	270 - 550	0.05 - 0.2	0.1 - 2

EME4400

Face endmill, shank type, with wedge clamp system

GAMP = +24°, GAMF = -13° ~ -8°

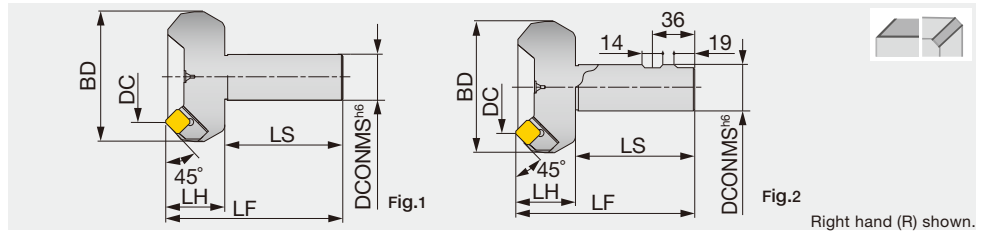
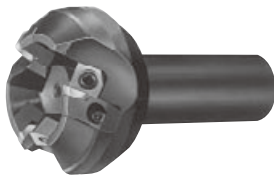

Designation	APMX	DC	CICT	BD	DCONMS	LS	LH	LF	Fig.	Insert
EME4450R	4	50	3	73.4	32	80	40	120	1	SE*N1203...
EME4463R	4	63	4	87.2	32	80	40	120	1	SE*N1203...
EME4403RI	4	80	5	101.5	32	80	40	120	2	SE*N1203...
EME4404RI	4	100	5	120.2	32	80	40	120	2	SE*N1203...

TME4400R/LI/B

Face mill, with wedge clamp system

GAMP = +24°, GAMF = -8° ~ -6°

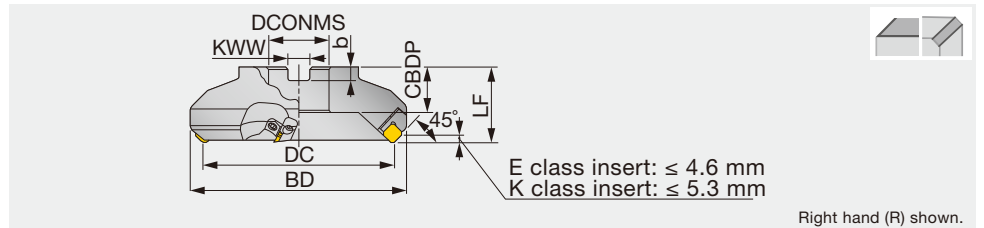

Designation	APMX	DC	CICT	BD	LF	DCONMS	CBDP	KWW	b	WT(kg)	Insert
TME4463RB-E	4	63	5	87.2	40	22	20	10.4	6.3	1.0	SE*N1203
TME4403R/LI	4	80	4	101.5	50	25.4	26	9.5	6	1.43	SE*N1203
TME4403RI-E	4	80	4	101.5	50	27	26	12.4	7	1.43	SE*N1203
TME4403RB	4	80	6	101.5	50	25.4	26	9.5	6	1.43	SE*N1203
TME4403RB-E	4	80	6	101.5	50	27	26	12.4	7	1.43	SE*N1203
TME4404R/LI	4	100	5	120.2	63	31.75	32	12.7	8	2.74	SE*N1203
TME4404RI-E	4	100	5	120.2	63	32	32	14.4	8	2.74	SE*N1203
TME4404RB	4	100	7	120.2	63	31.75	32	12.7	8	2.77	SE*N1203
TME4404RB-E	4	100	7	120.2	50	32	28.5	14.4	8	2.77	SE*N1203
TME4405R/LI	4	125	6	145.2	63	38.1	38	15.9	10	4.04	SE*N1203
TME4405RI-E	4	125	6	145.2	63	40	32	16.4	9	4.04	SE*N1203
TME4405RB	4	125	9	145.2	63	38.1	38	15.9	10	4.06	SE*N1203
TME4405RB-E	4	125	9	145.2	63	40	32	16.4	9	4.06	SE*N1203
TME4406R/LI	4	160	8	181.2	63	50.8	38	19	11	5.82	SE*N1203
TME4406RI-E	4	160	8	181.2	63	40	29	16.4	9	5.82	SE*N1203
TME4406RB	4	160	12	181.2	63	50.8	38	19	11	5.86	SE*N1203
TME4406RB-E	4	160	12	181.2	63	40	29	16.4	9	5.86	SE*N1203
TME4408R/LI	4	200	10	220.5	63	47.625	38	25.4	14	9.18	SE*N1203
TME4408RB	4	200	15	220.5	63	47.625	38	25.4	14	9.24	SE*N1203
TME4410R/LI	4	250	12	269.8	63	47.625	38	25.4	14	16.64	SE*N1203
TME4412RI	4	315	14	334.4	63	47.625	38	25.4	14	25.72	SE*N1203

Cutting edge height (LF) is for when SEEN1203AG*N type inserts are used.

Arbor type

TME4408/10R/LI,
TME4408RB

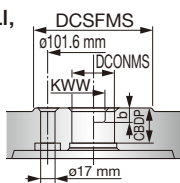

TME4412RI

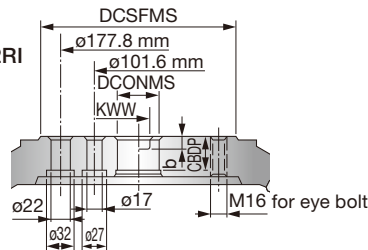

TME4406RI-E,
TME4406RB-E

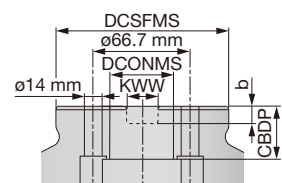

SPARE PARTS

Designation	Locator	Wedge fixing screw	Locator fixing screw	Wedge	Wrench
TME4463RB-E	LE444R	DS-8	CM4X0.7X14	WT402R	TP-4
EME4400..., TME4403R... - TME4405R... TME4403RB - TME4405RB	LE444R	FDS-8S	CM4X0.7X14	WF444R	TP-4
TME4403L... - TME4405L...	LE444L	FDS-8S	CM4X0.7X14	WF444L	TP-4
TME4406R... - TME4412R... TME4406RB, TME4408RB, TME4403 - 06RB-E	LE446R	FDS-8S	CM4X0.7X14	WF444R	TP-4
TME4406L... - TME4412L...	LE446L	FDS-8S	CM4X0.7X14	WF444L	TP-4

Recommended clamping torque: 8 N·m

Reference pages: Inserts → **H104**





INSERT

SECN/SEEN/SEKN /SEKR 1203

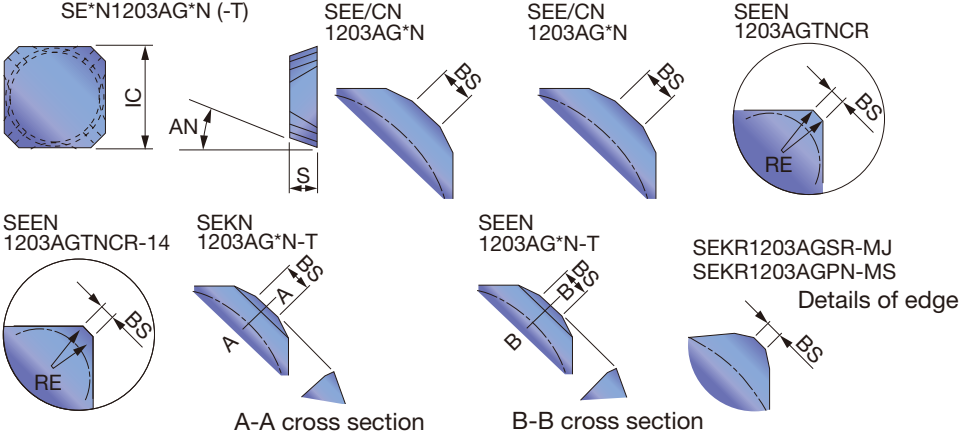

P Steel	☆	☆	☆	★	☆	★	★	☆					
M Stainless		★	☆	☆	☆								
K Cast iron	★					★							
N Non-ferrous									★				
S Superalloys	☆	☆											
H Hard materials													

★ : First choice
☆ : Second choice

Designation	APMX	Coated						Cermet	Uncoated		IC	S	AN	BS			
		AH120	AH130	AH140	AH330	GH330	T1115	T3130	NS740	UX30					TH10		
SECN1203AGFN	4									●				12.7	3.18	20	2.4
SEEN1203AGFN	4									●				12.7	3.18	20	2.4
SEEN1203AGTN	4	●	●	●		●	●		●	●				12.7	3.18	20	2.4
SEEN1203AGTN-T	4						●		●	●				12.7	3.18	20	2.4
SEEN1203AGTNCR	4	●	●	●	●		●							12.7	3.18	20	1.6
SEEN1203AGTNCR-14	4						●							12.7	3.18	20	1.4
SEKN1203AGFN-T	4									●				12.7	3.18	20	1.6
SEKN1203AGTN	4	●	●	●	●		●		●	●				12.7	3.18	20	1.6
SEKN1203AGTN-T	4					●	●	●	●	●				12.7	3.18	20	1.6
SEKN1203AGTNCR	4								●					12.7	3.18	20	1.6
SEKR1203AGSR-MJ	4	●			●	●	●							12.7	3.18	20	1.6
SEKR1203AGPN-MS	4		●	●										12.7	3.18	20	1.6

●: Line up

STANDARD CUTTING CONDITIONS

Please scan below.

e-catalog e-catalog e-catalog

EME4400 TME4400R/LI TME4400R/LB

TME5400RI

45° face mill, with wedge clamp system

GAMP = +24°, GAMF = -8° ~ -6°

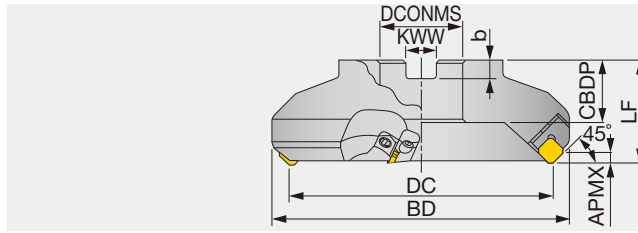
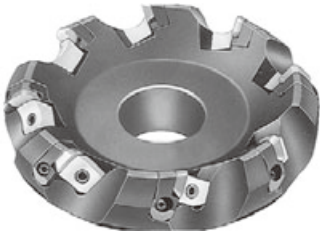

Right hand (R) shown.

Designation	APMX	DC	CICT	BD	LF	DCONMS	CBDP	KWW	b	WT(kg)	Insert
TME5404RI	6	100	5	123.6	63	31.75	32	12.7	8	2.82	SE**1504...
TME5405RI	6	125	6	148.6	63	38.1	38	15.9	10	4.08	SE**1504...
TME5406RI	6	160	8	183	63	50.8	38	19	11	5.99	SE**1504...
TME5408RI	6	200	10	223	63	47.625	38	25.4	14	9.23	SE**1504...
TME5410RI	6	250	12	273	63	47.625	38	25.4	14	16.94	SE**1504...
TME5412RI	6	315	14	338	63	47.625	38	25.4	14	25.94	SE**1504...

SPARE PARTS

Designation	Locator	Wedge fixing screw	Locator fixing screw	Wedge	Wrench
TME5400RI	LE540R	FDS-8S	CM4X0.7X14	WF540R	TP-4

Recommended clamping torque: 8 N·m

Arbor type

TME5408/10RI

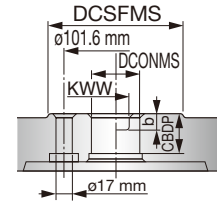

TME5412RI

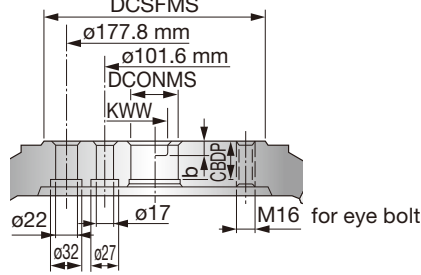

INSERT

SECN/SEEN/SEKN 1504

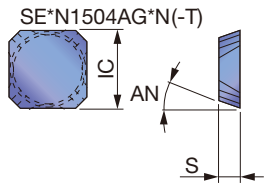

Details of edge

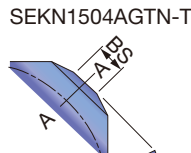
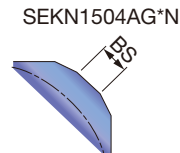

A-A cross section

SEKR1504-MJ

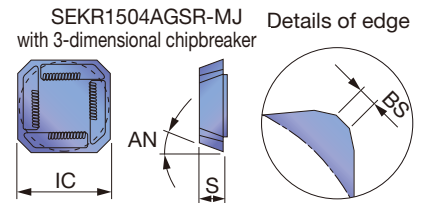

	Steel	Stainless	Cast iron	Non-ferrous	Superalloys	Hard materials
SECN1504AGN	☆	★	★	★	★	☆
SEEN1504AGTN	★					
SEKN1504AGTN-T				★		
SEKR1504AGSR-MJ						

★ : First choice
☆ : Second choice

Designation	APMX	Coated				Cermet	Uncoated		IC	S	AN	BS
		AH120	AH140	GH330	T3130	NS740	TH10	UX30				
SEEN1504AGTN	6					●			15.875	4.76	20°	2.4
SEKN1504AGFN	6							●	15.875	4.76	20°	1.6
SEKN1504AGTN	6	●	●	●	●	●	●		15.875	4.76	20°	1.6
SEKN1504AGTN-T	6					●			15.875	4.76	20°	1.6
SEKR1504AGSR-MJ	6			●	●				15.875	4.76	20°	1.6

●: Line up

STANDARD CUTTING CONDITIONS

Please scan below.

e-catalog





EMD4400RI

Endmill, shank type, with wedge clamp system

GAMP = +15°, GAMF = -3°

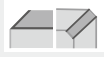
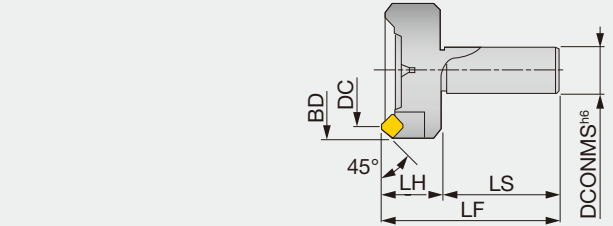

Right hand (R) shown.



Designation	APMX	DC	CICT	BD	DCONMS	LS	LH	LF	WT(kg)	Insert
EMD4403RI-S32	4	80	4	95	32	80	40	120	2	SD*N42.../SD*R1203.../ WDCN42ZFR-DIA



TMD4400R/LI

Face mill, with wedge clamp system

GAMP = +15°, GAMF = -3°

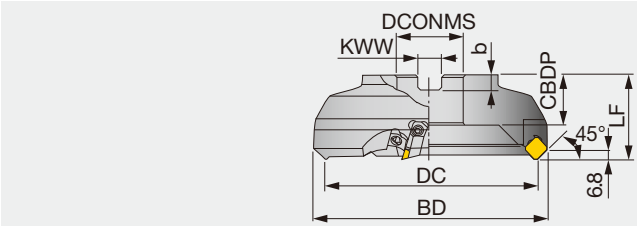

Right hand (R) shown.



Designation	APMX	DC	CICT	BD	LF	DCONMS	CBDP	KWW	b	WT(kg)	Insert
TMD4403R/LI	4	80	4	96	50	25.4	26	9.5	6	1.4	SD*N42.../SD*R1203.../ WDCN42ZFR-DIA
TMD4404R/LI	4	100	5	115	63	31.75	32	12.7	8	2.5	SD*N42.../SD*R1203.../ WDCN42ZFR-DIA
TMD4405R/LI	4	125	6	139	63	38.1	38	15.9	10	3.60	SD*N42.../SD*R1203.../ WDCN42ZFR-DIA
TMD4406R/LI	4	160	8	173	63	50.8	38	19	11	5.6	SD*N42.../SD*R1203.../ WDCN42ZFR-DIA
TMD4408R/LI	4	200	10	213	63	47.625	38	25.4	14	8.7	SD*N42.../SD*R1203.../ WDCN42ZFR-DIA
TMD4410R/LI	4	250	12	263	63	47.625	38	25.4	14	16.3	SD*N42.../SD*R1203.../ WDCN42ZFR-DIA
TMD4412RI	4	315	14	327	63	47.625	38	25.4	14	25.2	SD*N42.../SD*R1203.../ WDCN42ZFR-DIA



7°-25°

41°-45°



Arbor type

TMD4408/10R/LI

TMD4412RI

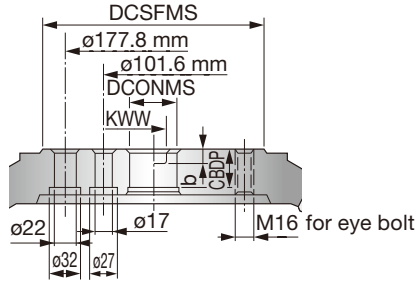
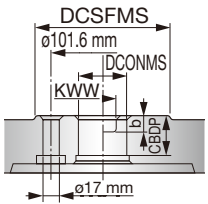

SPARE PARTS

Designation	Locator	Wedge fixing screw	Locator fixing screw	Wedge	Wrench
EMD4403RI-S32 TMD4403RI - TMD4412RI	LD440R	FDS-8S	CM4X0.7X14	WP440R	TP-4
TMD4403LI - TMD4410LI	LD440L	FDS-8S	CM4X0.7X14	WP440L	TP-4

Recommended clamping torque: 8 N·m

INSERT

SDCN/SDEN/SDKN 42Z

Regular edge
SD*N42Z*N

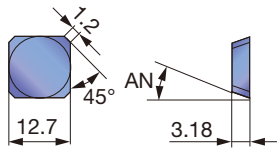

Details of edge
SDKN42ZTN16

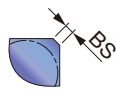

SD*N42ZTN20

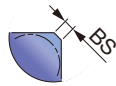

SDKN42ZTNCR
SDEN42ZTNCR

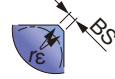

SDCN42ZFN-DIA

SDCN42ZFN-DIA

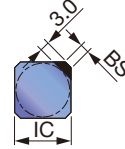

SDKR42Z-MJ

SDKR42ZSR-MJ
with 3-dimensional chipbreaker

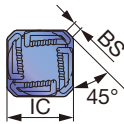

Details of edge

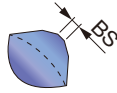

SDMR/SDKR 1203-MJ

SD*R1203AETN-MJ
with 3-dimensional chipbreaker

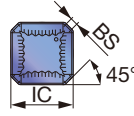

Details of edge

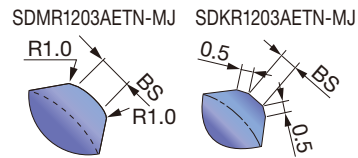

SDKR42Z-MS

SDKR42ZPN-MS

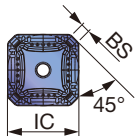

Details of edge

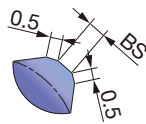

WDCN42ZFR-DIA

Wiper edge
WDCN42ZFR-DIA

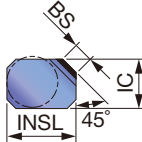

P	Steel	★	★		☆	☆			☆	☆	★	☆		☆						
M	Stainless	★		★	☆					☆										
K	Cast iron		★					☆	★											
N	Non-ferrous																★			★
S	Superalloys		★	☆																
H	Hard materials																			

★ : First choice
☆ : Second choice

Designation	APMX	Coated								Cermet		Uncoated		PCD	IC	INSL	S	AN	BS			
		AH3135	AH120	AH130	AH140	AH330	GH330	T1115	T1215	T3130	T3225	NS740	N308	UX30						TH10	DX140	
SDCN42ZFN	4																	12.7	-	3.18	15°	1.2
SDCN42ZTN	4										●	●		●				12.7	-	3.18	15°	1.2
SDCN42ZTN20	4										●							12.7	-	3.18	15°	2
SDEN42ZFN	4													●				12.7	-	3.18	15°	1.2
SDEN42ZTN	4	●	●		●		●	●	●		●	●		●				12.7	-	3.18	15°	1.2
SDEN42ZTNCR	4	●	●		●	●					●							12.7	-	3.18	15°	1.6
SDEN42ZTN20	4															●	●	12.7	-	3.18	15°	2
SDKN42ZFN	4															●		12.7	-	3.18	15°	1.2
SDKN42ZTN	4	●	●	●	●	●	●	●	●		●	●		●				12.7	-	3.18	15°	1.2
SDKN42ZTNCR	4										●							12.7	-	3.18	15°	1.6
SDKN42ZTN16	4																	12.7	-	3.18	15°	1.6
SDCN42ZFN-DIA	2														●			12.7	-	3.18	15°	1.2
SDKR42ZSR-MJ	4	●	●		●	●												12.7	-	3.18	15°	1.6
SDMR1203AETN-MJ	4										●							12.7	-	3.18	15°	1.6
SDKR1203AETN-MJ	4										●							12.7	-	3.18	15°	1.6
SDKR42ZPN-MS	4	●		●	●													12.7	-	3.18	15°	1.6
WDCN42ZFR-DIA	0.5														●			12.2	15.64	3.18	15°	4.9

● : Line up

DX140: 1 piece per package

STANDARD CUTTING CONDITIONS

Please scan below.

e-catalog



e-catalog



EMD4400RI TMD4400R/LI





TMD5400RI

Face mill, with wedge clamp system

GAMP = +15°, GAMF = -3°

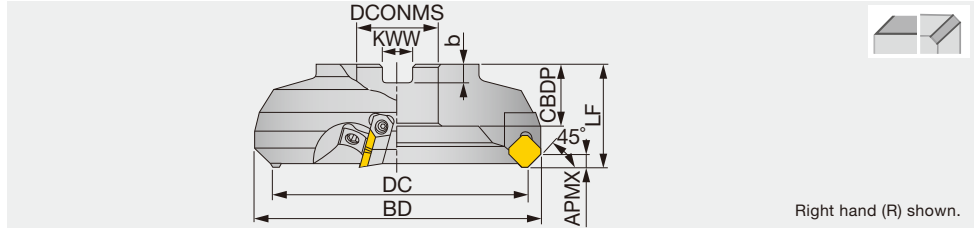

Right hand (R) shown.



Designation	APMX	DC	CICT	BD	LF	DCONMS	CBDP	KWW	b	WT(kg)	Insert
TMD5404RI	6	100	4	118	63	31.75	32	12.7	8	2.5	SD*N53Z...
TMD5404RI-E	6	100	4	118	50	32	28.5	14.4	8	2.5	SD*N53Z...
TMD5405RI	6	125	6	142	63	38.1	38	15.9	10	2.5	SD*N53Z...
TMD5405RI-E	6	125	6	142	63	40	32	16.4	9	3.7	SD*N53Z...
TMD5406RI	6	160	6	176	63	50.8	38	19	11	5.8	SD*N53Z...
TMD5406RI-E	6	160	6	176	63	40	29	16.4	9	5.8	SD*N53Z...
TMD5408RI	6	200	8	216	63	47.625	38	25.4	14	9	SD*N53Z...
TMD5408RI-E	6	200	8	216	63	60	38	25.7	14	9	SD*N53Z...
TMD5410RI	6	250	10	265	63	47.625	38	25.4	14	16.3	SD*N53Z...
TMD5410RI-E	6	250	10	265	63	60	38	25.7	14	16.3	SD*N53Z...
TMD5412RI	6	315	12	330	63	47.625	38	25.4	14	25.2	SD*N53Z...
TMD5412RI-E	6	315	12	330	63	60	38	25.7	14	25.2	SD*N53Z...

Arbor type

TMD5406RI-E

TMD5408/10...

TMD5412RI

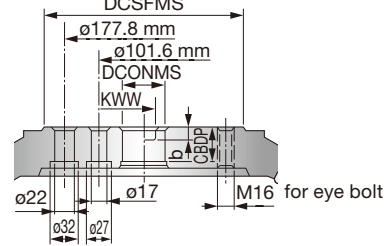
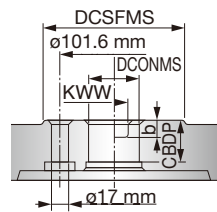
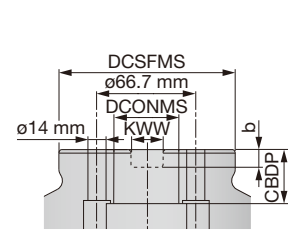

Approach angle



SPARE PARTS

Designation	Locator	Wedge fixing screw	Locator fixing screw	Wedge	Wrench
TMD54**RI*	LD540R	FDS-8S	CM4X0.7X20	WF500R	TP-4

Recommended clamping torque: 8 N·m

INSERT

SDCN/SDEN 53Z

SD*N53Z*N

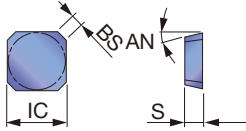

SDEN53ZTN20
Details of edge

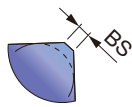

SDKN53ZTN16
Details of edge

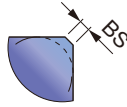

SDEN53ZTNCR
Details of edge

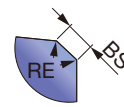

SDKN53ZTNCR
Details of edge

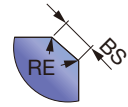

SDKR53-MJ

SDKR53ZSR-MJ
with 3-dimensional chipbreaker

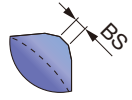
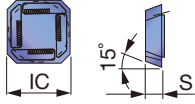

P Steel	☆				★															
M Stainless		★	☆	☆																
K Cast iron	★																			
N Non-ferrous																				★
S Superalloys																				
H Hard materials																				

★ : First choice
☆ : Second choice

Designation	APMX	Coated					Cermet		Uncoated		IC	S	AN	BS
		AH120	AH130	AH140	GH330	T3130	NS740	N308	UX30	TH10				
SDCN53ZTN	6						●	●			15.875	4.76	15°	1.2
SDEN53ZFN	6								●		15.875	4.76	15°	1.2
SDEN53ZTN	6				●		●		●		15.875	4.76	15°	1.2
SDEN53ZTNCR	6						●				15.875	4.76	15°	1.4
SDEN53ZTN20	6					●					15.875	4.76	15°	2
SDKN53ZFN	6								●		15.875	4.76	15°	1.2
SDKN53ZTN	6	●	●	●	●		●	●	●		15.875	4.76	15°	1.2
SDKN53ZTNCR	6						●				15.875	4.76	15°	1.6
SDKN53ZTN16	6					●					15.875	4.76	15°	1.6
SDKR53ZSR-MJ	6				●	●					15.875	4.76	15°	2

● : Line up

STANDARD CUTTING CONDITIONS

Please scan below.

e-catalog



Grade
Insert
Ext. Toolholder
Int. Toolholder
Threading
Grooving
Miniature tool
Milling cutter
Endmill
Drilling tool
Tooling System
User's Guide
Index



- High Feed Milling
- Face Milling
- Shoulder Milling
- Slot Milling
- Profile Milling
- Chamfering, Counterbore
- Finish Face Milling
- Approach angle
- 7°-25°
- 41°-45°
- 60°-70°
- 85°-88°
- 90°
- Others

EGD4400

45° face endmill, shank type, with wedge clamp system

GAMP = +15°, GAMF = -3°

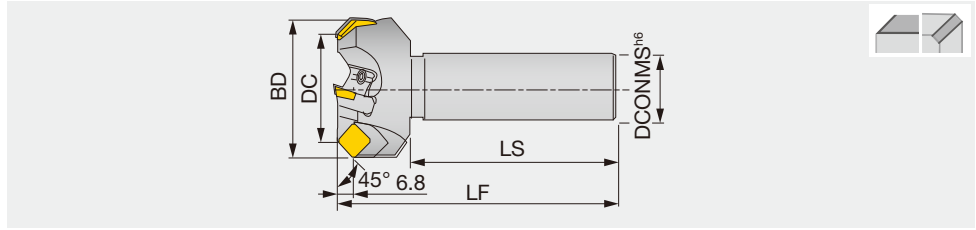

Designation	APMX	DC	CICT	BD	DCONMS	LS	LH	LF	WT(kg)	Insert
EGD4450R	4	50	4	67	32	80	35	115	1.1	SD*N42.../SD*R1203.../ WDCN42ZFR-DIA
EGD4463R	4	63	4	79	32	80	35	115	1.4	SD*N42.../SD*R1203.../ WDCN42ZFR-DIA

TGD4400-A

45° face mill, with wedge clamp system

GAMP = +15°, GAMF = -3°

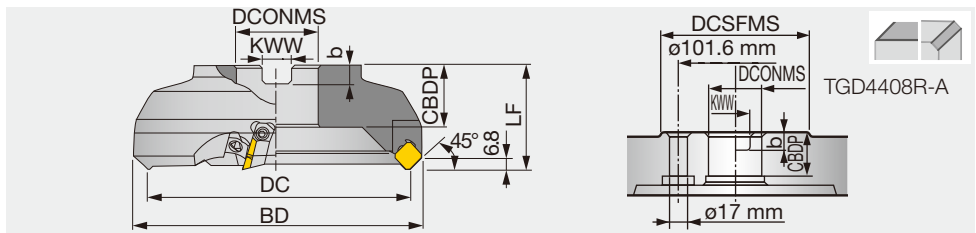

Designation	APMX	DC	CICT	BD	LF	DCONMS	CBDP	KWW	b	WT(kg)	Insert
TGD4403R-A	4	80	6	96	50	25.4	26	9.5	6	1.4	SD*N42.../SD*R1203.../ WDCN42ZFR-DIA
TGD4404R-A	4	100	6	115	63	31.75	32	12.7	8	2.5	SD*N42.../SD*R1203.../ WDCN42ZFR-DIA
TGD4405R-A	4	125	8	139	63	38.1	38	15.9	10	3.6	SD*N42.../SD*R1203.../ WDCN42ZFR-DIA
TGD4406R-A	4	160	8	173	63	50.8	38	19	11	5.6	SD*N42.../SD*R1203.../ WDCN42ZFR-DIA
TGD4408R-A	4	200	10	213	63	47.625	38	25.4	14	8.7	SD*N42.../SD*R1203.../ WDCN42ZFR-DIA

SPARE PARTS

Designation	Locator	Wedge fixing screw	Locator fixing screw	Wedge	Wrench
EGD4400	LD442R	DS-8	BM3X0.5X6	WP193TR	TP-4
TGD4400-A	LD440R	FDS-8S	CM4X0.7X14	WP440R	TP-4

Recommended clamping torque: 8 N·m

INSERT

SDCN/SDEN/SDKN 42Z

Regular edge
SD*N42Z*N

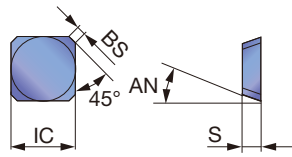

Details of edge
SDKN42ZTN16

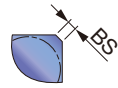

SD*N42ZTN20

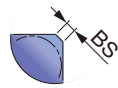

SDKN42ZTNCR
SDEN42ZTNCR

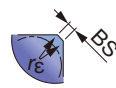

SDCN42ZFN-DIA

SDCN42ZFN-DIA

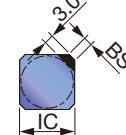

SDKR42Z-MJ

SDKR42ZSR-MJ
with 3-dimensional
chipbreaker

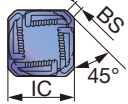

Details of edge

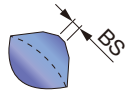

SDMR/SDKR 1203-MJ

SD*R1203AETN-MJ
with 3-dimensional
chipbreaker

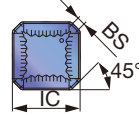

Details of edge
SDMR1203AETN-MJ

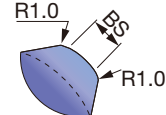

SDKR1203AETN-MJ

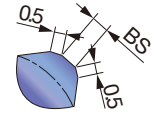

SDKR42Z-MS

SDKR42ZPN-MS

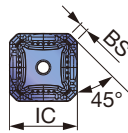

Details of edge

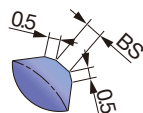

WDCN42ZFR-DIA

Wiper edge
WDCN42ZFR-DIA

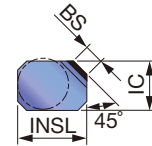

P Steel	★	★		☆	☆		☆	☆	★	☆	☆						
M Stainless	★		★	☆						☆							
K Cast iron		★					☆	★									
N Non-ferrous													★			★	
S Superalloys		★	☆														
H Hard materials																	

★ : First choice
☆ : Second choice

Designation	APMX	Coated										Cermet		Uncoated		PCD	IC	INSL	S	AN	BS	
		AH3135	AH120	AH130	AH140	AH330	GH330	T1115	T1215	T3130	T3225	NS740	N308	UX30	TH10	DX140						
SDCN42ZFN	4														●			12.7	-	3.18	15°	1.2
SDCN42ZTN	4												●	●	●			12.7	-	3.18	15°	1.2
SDCN42ZTN20	4												●					12.7	-	3.18	15°	2
SDEN42ZFN	4														●			12.7	-	3.18	15°	1.2
SDEN42ZTN	4	●	●		●	●	●	●				●	●		●			12.7	-	3.18	15°	1.2
SDEN42ZTNCR	4	●	●		●	●						●						12.7	-	3.18	15°	1.6
SDEN42ZTN20	4									●	●							12.7	-	3.18	15°	2
SDKN42ZFN	4														●			12.7	-	3.18	15°	1.2
SDKN42ZTN	4	●	●	●	●	●	●	●	●			●	●		●			12.7	-	3.18	15°	1.2
SDKN42ZTNCR	4												●					12.7	-	3.18	15°	1.6
SDKN42ZTN16	4																	12.7	-	3.18	15°	1.6
SDCN42ZFN-DIA	2															●		12.7	-	3.18	15°	1.2
SDKR42ZSR-MJ	4	●	●		●	●				●	●							12.7	-	3.18	15°	1.6
SDMR1203AETN-MJ	4											●						12.7	-	3.18	15°	1.6
SDKR1203AETN-MJ	4											●						12.7	-	3.18	15°	1.6
SDKR42ZPN-MS	4	●		●	●													12.7	-	3.18	15°	1.6
WDCN42ZFR-DIA	0.5															●		12.2	15.64	3.18	15°	4.9

● : Line up

DX140: Packing Quantity = 1 pc.

STANDARD CUTTING CONDITIONS

Please scan below.

e-catalog



EGD4400

e-catalog



TGD4400-A



TGP4100RIA/BAA/RBAE

75° face mill, with wedge clamp system

GAMP = +7°, GAMF = +1°

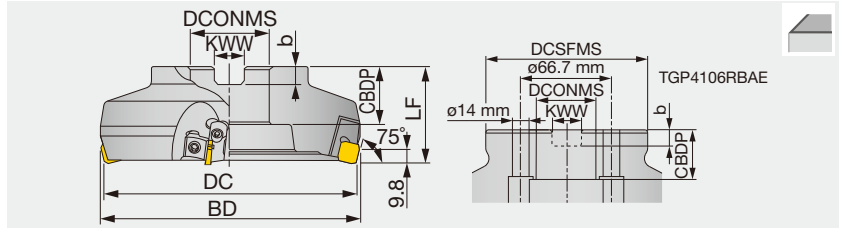

Designation	APMX	DC	CICT	BD	LF	DCONMS	CBDP	KWW	b	WT(kg)	Insert
TGP4103RIA	7	80	5	89	50	25.4	26	9.5	6	1.3	SP*N42..., WPAN42...
TGP4104RIA	7	100	6	108	63	31.75	32	12.7	8	2.4	SP*N42..., WPAN42...
TGP4104RBA	7	100	8	108	63	31.75	32	12.7	8	2.4	SP*N42..., WPAN42...
TGP4104RBAE	7	100	8	108	63	32	25	14.4	8	2.4	SP*N42..., WPAN42...
TGP4105RIA	7	125	8	132	63	38.1	38	15.9	10	3.6	SP*N42..., WPAN42...
TGP4105RBA	7	125	10	132	63	38.1	38	15.9	10	3.6	SP*N42..., WPAN42...
TGP4105RBAE	7	125	10	132	63	40	32	16.4	9	3.6	SP*N42..., WPAN42...
TGP4106RIA	7	160	8	167	63	50.8	38	19	11	5.9	SP*N42..., WPAN42...
TGP4106RBA	7	160	12	167	63	50.8	38	19	11	5.8	SP*N42..., WPAN42...
TGP4106RBAE	7	160	12	167	63	40	29	16.4	9	5.8	SP*N42..., WPAN42...

SPARE PARTS

Designation	Locator	Wedge fixing screw	Locator fixing screw	Wedge	Wrench
TGP4103RIA	LP413R	FDS-8S	CM4X0.7X14	WF310R	TP-4
TGP4104, 05, 06RIA	LP413R	FDS-8S	CM4X0.7X14	WF440R	TP-4
TGP4104, 05, 06RBA	LP413R	FDS-8S	CM4X0.7X14	WF310R	TP-4
TGP4104, 05, 06RBAE	LP413R	FDS-8S	CM4X0.7X14	WF310R	TP-4

Recommended clamping torque: 8 N·m

INSERT

SPCN/SPEN/SPKN 42S

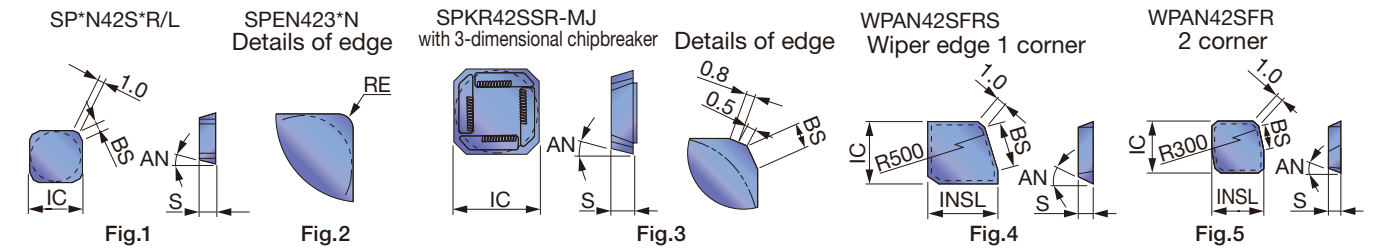

Right hand (R) shown.

	P	M	K	N	S	H
Steel	☆	☆	★	★	☆	☆
Stainless	☆	★	★	★	☆	☆
Cast iron	☆	☆	★	★	☆	☆
Non-ferrous	☆	☆	☆	☆	☆	☆
Superalloys	☆	☆	☆	☆	☆	☆
Hard materials	☆	☆	☆	☆	☆	☆

★ : First choice
☆ : Second choice

Designation	RE	APMX	Coated					Cermet		Ceramic	Uncoated		IC	INSL	S	AN	BS	Fig.	
			AH120	AH140	GH330	T1115	T3130	NS740	N308	FX105	UX30	TH10							
SPCN42STR	0	7						●	●			●		12.7	-	3.18	11°	1.4	1
SPCN42SFR	0	7										●		12.7	-	3.18	11°	1.4	1
SPEN42STR	0	7						●						12.7	-	3.18	11°	1.4	1
SPKN42STR	0	7	●	●	●	●	●	●	●	●*	●			12.7	-	3.18	11°	1.4	1
SPKN42STL	0	7						●						12.7	-	3.18	11°	1.4	1
SPKN42SFR	0	7										●		12.7	-	3.18	11°	1.4	1
SPKN42SFL	0	7										●		12.7	-	3.18	11°	1.4	1
SPKR42SSR-MJ	0	7		●	●	●								12.7	-	3.18	11°	0	3
WPAN42SFERS	0	-										●		12.4	14.9	3.18	11°	9.7	4
WPAN42SFR	0	-						●				●		12.4	13.8	3.18	11°	5.2	5
SPGN120312TN	1.2	7								●*				12.7	-	3.18	11°	-	2
SPEN423TN*	1.2	7				●		●				●		12.7	-	3.18	11°	-	2
SPEN423FN*	1.2	7										●		12.7	-	3.18	11°	-	2

Note: Insert marked with * and a wiper insert should not be used together.

● : Line up

STANDARD CUTTING CONDITIONS

Please scan below.

e-catalog



TGP4200R-A

Face mill, with wedge clamp system

GAMP = +5°, GAMF = +1°

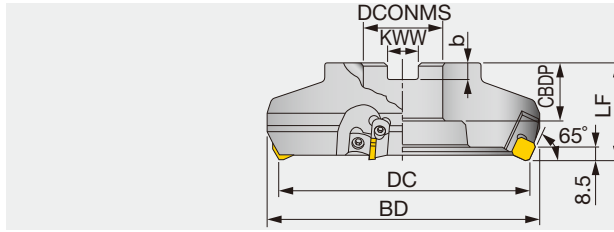

Right hand (R) shown.

Designation	APMX	DC	CICT	BD	LF	DCONMS	CBDP	KWW	b	WT(kg)	Insert
TGP4203R-A	6	80	5	95	50	25.4	26	9.5	6	1.4	SP*N42.../ WPAN42ZFR
TGP4204R-A	6	100	6	114	63	31.75	32	12.7	8	2.4	SP*N42.../ WPAN42ZFR
TGP4205R-A	6	125	8	139	63	38.1	38	15.9	10	3.9	SP*N42.../ WPAN42ZFR
TGP4206R-A	6	160	10	174	63	50.8	38	19	11	6.1	SP*N42.../ WPAN42ZFR

SPARE PARTS

Designation	Locator	Wedge fixing screw	Locator fixing screw	Wedge	Wrench
TGP42**R-A	LP413R	FDS-8S	CM4X0.7X14	WP440R	TP-4

Recommended clamping torque: 8 N·m

INSERT

SPAN/SPCN/SPEN/SPKN 42Z

Regular edge
SP*N42Z*R/L

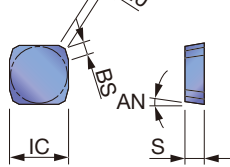

Fig.1

SPEN423*N

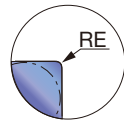

Fig.2

Wiper edge 2 corners
WPAN42Z*R/L

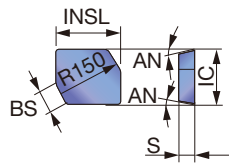

Fig.3

Right hand (R) shown.

	P	M	K	N	S	H
Steel	★					
Stainless						
Cast iron	★					
Non-ferrous						
Superalloys						
Hard materials						

★ : First choice
☆ : Second choice

Designation	APMX	Coated		Cermet		Uncoated		IC	INSL	S	AN	BS	RE	Fig.
		T1115	T3130	NS740	X407	N308	UX30							
SPAN42ZFR	6						●	12.7	-	3.18	11°	2	-	1
SPCN42ZFL	6						●	12.7	-	3.18	11°	2	-	1
SPCN42ZFR	6						●	12.7	-	3.18	11°	2	-	1
SPCN42ZTR	6				●	●	●	12.7	-	3.18	11°	2	-	1
SPEN423TN	6		●		●		●	12.7	-	3.18	11°	-	1.2	2
SPEN423FN	6						●	12.7	-	3.18	11°	-	1.2	2
SPEN42ZTR	6				●			12.7	-	3.18	11°	2	-	1
SPKN42ZFL	6						●	12.7	-	3.18	11°	2	-	1
SPKN42ZFR	6						●	12.7	-	3.18	11°	2	-	1
SPKN42ZTR	6	●	●		●	●	●	12.7	-	3.18	11°	2	-	1
WPAN42ZFR	6						●	12.2	14.28	3.18	11°	4.5	-	3

● : Line up

STANDARD CUTTING CONDITIONS

Please scan below.

e-catalog





TGP5100RIA

Face mill, with wedge clamp system

GAMP = +7°, GAMF = +1°

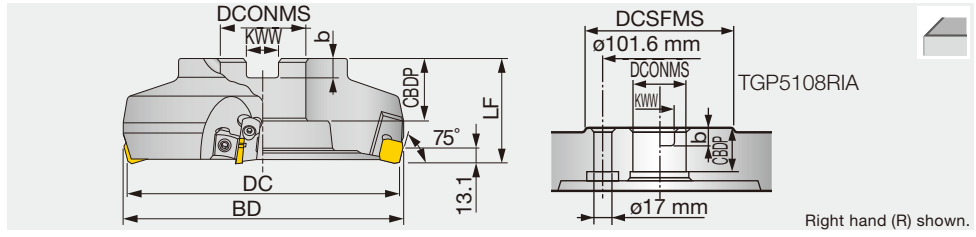

Right hand (R) shown.

Designation	APMX	DC	CICT	BD	LF	DCONMS	CBDP	KWW	b	WT(kg)	Insert
TGP5104RIA	10	100	5	109	63	31.75	32	12.7	8	2.3	SP*N53...
TGP5105RIA	10	125	6	133	63	38.1	38	15.9	10	3.5	SP*N53...
TGP5106RIA	10	160	8	167	63	50.8	38	19	11	5.7	SP*N53...
TGP5108RIA	10	200	10	207	63	47.625	38	25.4	14	8.4	SP*N53...

SPARE PARTS

Designation	Locator	Wedge fixing screw	Locator fixing screw	Wedge	Wrench
TGP51**RIA	LP514R	FDS-8S	CM4X0.7X14	WF500R	TP-4

Recommended clamping torque: 8 N·m

INSERT

SPCN/SPKN 53S

SP*N53S*R/L

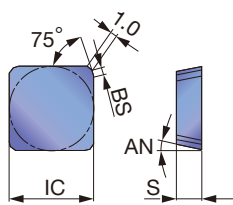

Fig.1

SPKN53STR20

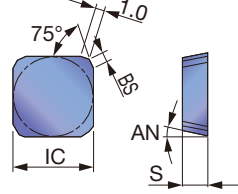

Fig.2

SPKR53SSR-MJ with 3-dimensional chipbreaker

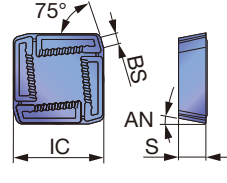

Fig.3

Right hand (R) shown.

	P	M	K	N	S	H
Steel	★					
Stainless	★	☆				
Cast iron		★				
Non-ferrous						
Superalloys						
Hard materials						

★ : First choice
☆ : Second choice

Designation	APMX	Coated		Cermet		Uncoated		IC	S	AN	BS	Fig.
		GH330	T1115	T3130	NS740	N308	UX30					
SPCN53SFR	10						●	15.875	4.76	11°	1.2	1
SPCN53STR	10				●		●	15.875	4.76	11°	1.2	1
SPKN53SFR	10						●	15.875	4.76	11°	1.2	1
SPKN53STL	10						●	15.875	4.76	11°	1.2	1
SPKN53STR	10	●	●		●		●	15.875	4.76	11°	1.2	1
SPKN53STR20	10			●				15.875	4.76	11°	2	2
SPKR53SSR-MJ	10	●	●					15.875	4.76	11°	2	3

●: Line up

STANDARD CUTTING CONDITIONS

Please scan below.

e-catalog



S-TAQ System

The world's highest level repeatability

S-TAQ System

Improved surface quality and increased tool life

- Two-face restricted (1/10 short taper and flange face) coupling.
- High-level coupling performance contributes to high accuracy and excellent rigidity.
- Excellent dynamic balance reduces vibration, chatter, and cutting noise at high speeds.

Improved productivity

- High speed machining can reduce machining time.
- High repeatability can eliminate trial cut.



Labor-saving tool change

- Can eliminate detaching the toolholder from the main spindle.
- Can eliminate the brakes for the main spindle.
- Labor-saving clamping by only one T-wrench.

Performance

Original clamp system provides high rigidity, accuracy and operating speed.

Clamping force (Strong clamp system)

- Lubricant coating on clamping piece.
- 4-points balancing clamp.
- Sufficient clamping for the smaller diameter part of taper.

Designation	Dimensions (mm)				S/M	K	Recommend clamping torque (N·m)	Clamping force (N)
	D CONWS	BD	ℓ 1	ℓ 2				
TAQ32	19	32	18	8.5	3/M6	8	3	4×10^3
TAQ40	24	40	21	10	3/M6	10	5	5.5×10^3
TAQ50	30	50	25	12	4/M8	12	8	9×10^3
TAQ63	38	63	32	15	4/M8	16	10	12×10^3
TAQ80	48	80	40	18	5/M10	18	20	18×10^3
TAQ100	60	100	50	22	6/M12	20	30	23×10^3

Comparison of clamping force

	Taper	Taper dia.(mm) / holder dia.(mm)	Recommend clamping torque (N/m)	Draw-in force (N)	Draw-in force / Torque (m-1)
TAQ63	1 / 10	38 / 63	10	12×10^3	1200
QC adapter	10°	35 / 70	20	9.8×10^3	490
Other makes A	4°	35 / 62	22.5	9.8×10^3	436

Repeatability for accuracy

Radial run out	Within 0.003 mm
Axial run out	Within 0.002 mm

Note: Measured at 150 mm far from end face.

Part assembly

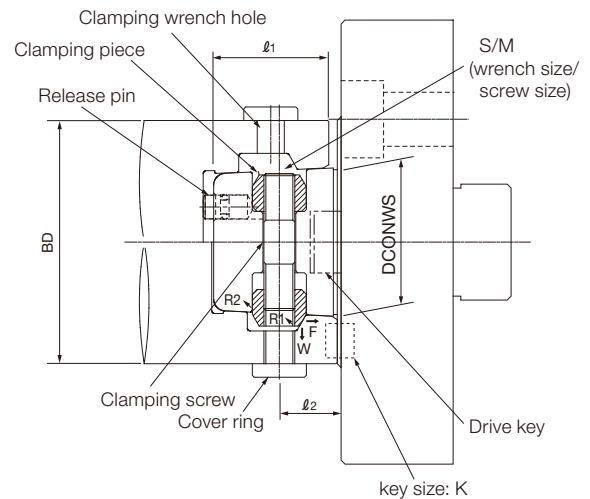

W: Driving force by clamping screw
 F: Clamping force
 R1 = R2: Receiving force of clamping piece

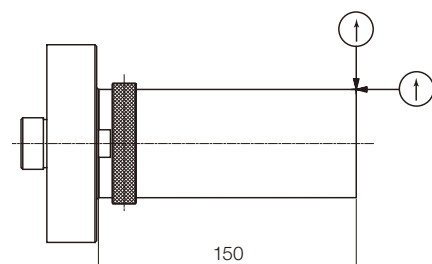



QC system for TAC Mills

TAC mills QC system facilitate easy and quick mounting of the cutter body (face milling cutter, etc.) to the machine tools.

Small dia. TAC mills QC system Dia. $\phi 80 \sim 160$ mm

Type A QC system

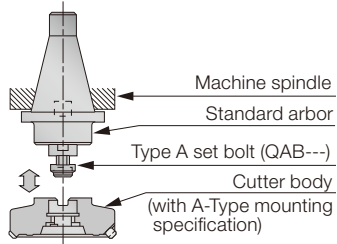

Features

- Cutter body replacement is possible without removing the bolt.
- A QC system is made up only by installing the Type A set bolt to our standard arbor. (The cutter body is made to A-Type mounting specification.)
- Standard arbor used ensures superior economy and rigidity.

Replacement method

Mounting - Direct the set bolt direction to align with the cutter spot facing hole, then mount the cutter. Turn the set bolt one to two turns for tightening.

Removal - Loosen the bolt one turn, press the cutter to the spindle, and turn the set bolt one to two turns. The cutter can now be removed.

A-type QC Mounting System for Small Diameter TAC Mills

Dimensional details of mount (For $\phi 80$ to $\phi 160$ mm dia. TAC mills)

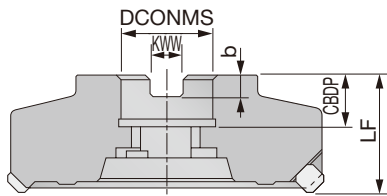

Cutter dia. (mm)	Dimensions (mm)				
	DCONMS	b	KWW	CDBP	LF
$\phi 80$	25.4	6	9.5	20	50
$\phi 100$	31.75	8	12.7	22	50
$\phi 125$	38.1	10	15.9	27	63
$\phi 160$	50.8	11	19	27	63

Arbors

Standard arbors (FMA, FMC type) can't be used. Special arbors applicable for below dimensions can be made to order on request.

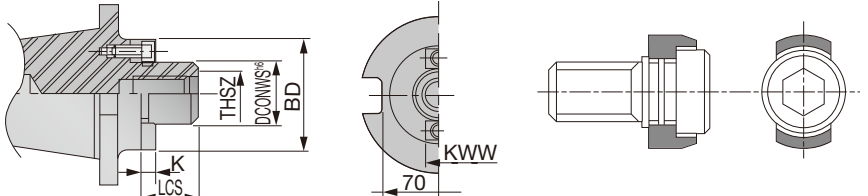

Dimensions (mm)						Cutter fixing screw for A-type	Hex wrench size(mm)
DCONWS	BD	THSZ	LCS	KWW	K		
25.4	50	M12	18	9.5	5	QAB-3 (R/L)	Hex. Socket-head screw M12 x 30 10
31.75	60	M16	20	12.7	7	QAB-4 (R/L)	Hex. Socket-head screw M12 x 30 14
38.1	80	M20	25	15.9	9	QAB-5 (R/L)	17
50.8	100	M24	25	19.05	10	QAB-6 (R/L)	19

Type B QC system

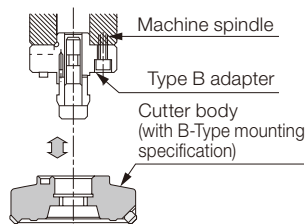

Features

- Cutter body replacement is possible without removing the bolt.
- Loosening of the adapter is not enough to remove the cutter. This is to prevent the cutter from falling.
- Type B QC adapter and Type B cutter installation are necessary.
- It is not necessary to set the set bolt direction with that of the cutter hole. The cutter is fit into the adapter only by aligning the match marks.

Replacement method

Mounting - Set the cutter into the adapter. Direct the cutter match mark to align with that of adapter, then the cutter enters the adapter. Turn the cutter by 90° and turn adapter bolt one to two turns for tightening.

Removal - Loosen adapter bolt by one or two turns and turn the cutter by 90°. The cutter can now be removed.

B-type QC Mounting System for Small Diameter TAC Mills

Dimensional details of mount (For $\phi 80$ to $\phi 160$ mm dia. TAC mills)

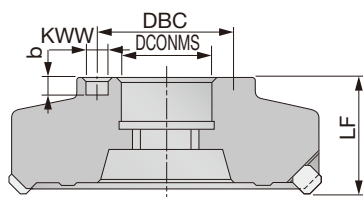

Cutter dia.	Dimensions (mm)				
	DCONMS	b	KWW	LF	DBC
$\phi 80$	25.4	7	10	50	45
$\phi 100$	31.75	7	12	63	55
$\phi 125$	38.1	7	15	63	70
$\phi 160$	50.8	7	18	63	85

Dimensional details of B-type adapters

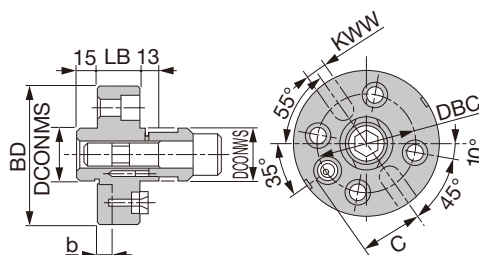

Cutter dia.	Dimensions (mm)								
	DCONWS	c	BD	DCONMS	KWW	b	DBC	S	LB
$\phi 80$	25.4	22.5	80	25.4	9.5	7	45	M10	25
$\phi 100$	31.75	27.5	100	31.75	12.7	8	55	M10	25
$\phi 125$	38.1	35	100	38.1	15.9	10	70	M12	30
$\phi 160$	50.8	42.5	125	50.8	19	11	85	M16	30

Instead of the above B-type adapters, BT- and T-type arbors can be also used for B-type QC mount cutters. These arbors are made to order on request.

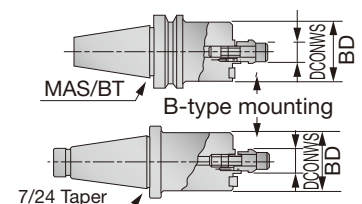

QC system for TAC Mills

Large dia. TAC mills QC system Dia. $\phi 200$ mm -

Type OB QC system (Elongated mounting hole type)

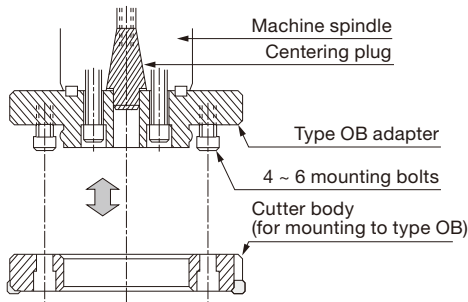

Features

- The cutter body can be replaced without removing bolt.
- Cutter does not fall when only the bolt is removed.
- The cutter body weight is about one half of usual cutter.
- The cutter bolt is fixed to the adapter with four to six large bolts, ensuring high rigidity.

Replacement method

Mounting - Align the adapter tightening bolts (4 ~ 6) to the cutter mounting holes, turn the cutter whilst pressing it against the adapter, and turn the bolt to tighten.

Removal - Loosen the bolt slightly, and by one turn, turn the cutter to remove it from the adapter.

OB-type QC Mounting System for Large Diameter TAC Mills (Elongated mounting hole type)

Cutter body ($\phi 200$ - $\phi 400$ mm)

This system is applied to "flush edge-top" Standard type TAC mills with OB mount.

For the details of the OB-type cutter bodies.

OB type adapter

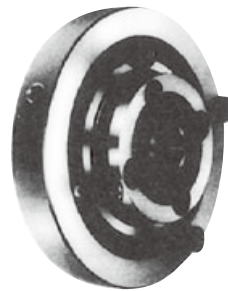

OB type cutter body



Dimensional details of mount of OB-type adapters

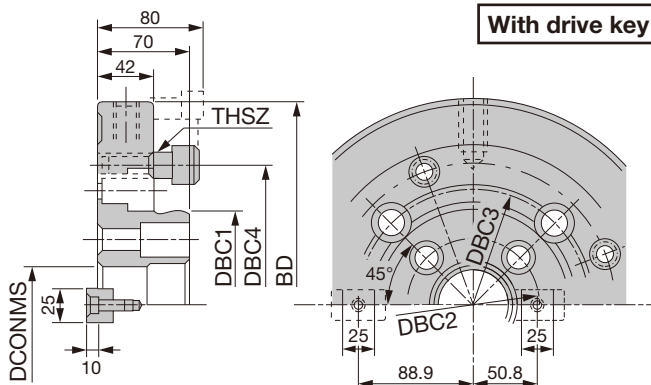

QA12K to QA16K type shown.

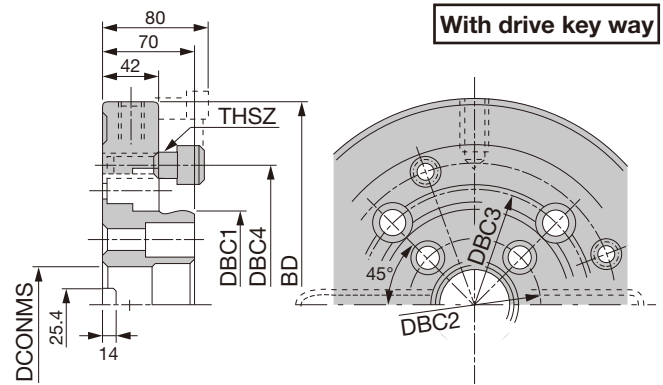

QA12M to QA16M type shown.

Adapter Designation	Dimensions (mm)							
	BD	DCONMS	DBC1	DBC2	DBC3	DBC4	THSZ	Bolts
QA08K/M	198	47.625	63.5	101.6	-	114.3	M16x40	4
QA10K/M	248	60	133.35	101.6	-	177.8	M16x50	4
QA12K/M	313	60	146.05	101.6	177.8	215.9	M20x50	4
QA14K/M	353	60	215.9	101.6	177.8	260.4	M20x50	6
QA16K/M	398	60	254	101.6	177.8	304.8	M20x50	6

- Notes:
- Dimension ϕd can be made to customer's specifications.
 - Special centering plugs for $\phi 60$ mm hole are made to order.

Notes: In Designation, K indicates "with drive key" type, and M indicates "with drive key way" type. ("N" shows number of tapped holes.)





Large dia. TAC mills QC system Dia. ϕ 200 mm -

Type CB QC system (Center bolt type)

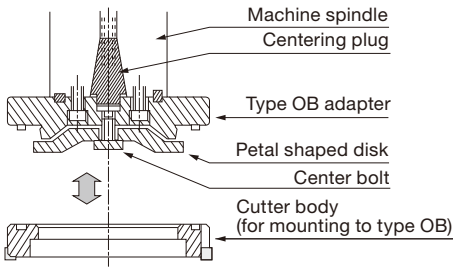

Features

- Move the petal-shaped disk up and down with one center bolt in the adapter, removing the cutter. Since only one bolt is used, replacement takes only one half of the time required by Type CB.
- The cutter body is lighter by 20% than that of OB type and easy to handle.
- Compatible with auto clamp unit.
- The cutter does not fall when the center bolt only is loosened.

Replacement method

- Mounting** - Align the cutter notch with the adapter clammer and turn the cutter whilst pressing it against the adapter. Tighten with the center bolt.
- Removal** - Loosen the center bolt once and lift the cutter upward in the spindle direction. Turn the cutter further slightly, and the cutter can be removed from the adapter.

CB-type QC Mounting System for Large Diameter TAC Mills (Center bolt type)

Cutter body (ϕ 200 - ϕ 400 mm)

This system is applied to "flush edge-top" type TAC mills with CB mount.

CB type adapter



CB type cutter body



Dimensional details of mount of CB-type adapters

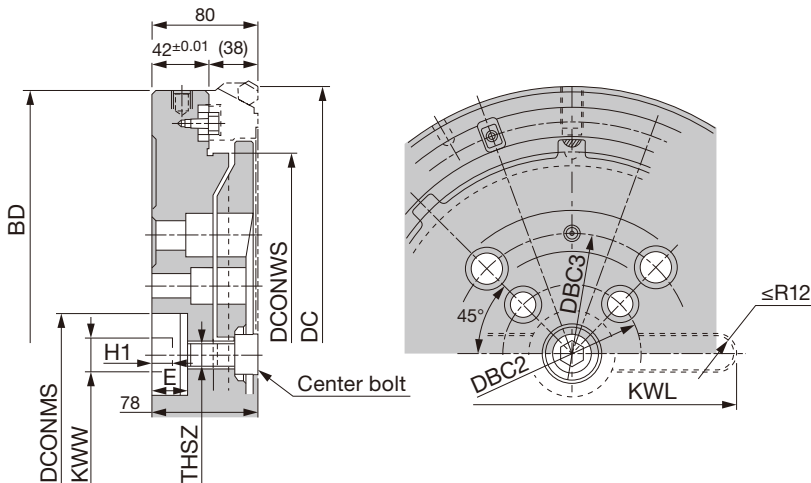

Adapter Designation	Dimensions (mm)											Center bolt
	DC	DCONMS	BD	DCONWS	DBC2	DBC3	KWW	H1	KWL	THSZ	E	
QACB-08MR/L	200	47.625	195	119.97	101.6	-	25.4	14	150	M20	25	TMBA-M20
QACB-10MR/L	250	60	245	159.97	101.6	-	25.4	14	150	M20	25	TMBA-M20
QACB-12MR/L	315	60	310	214.97	101.6	-	25.4	14	150	M20	25	TMBA-M20
QACB-14MR/L	355	60	350	254.97	-	177.8	25.4	14	245	M20	25	TMBA-M20
QACB-16MR/L	400	60	395	299.95	-	177.8	25.4	14	245	M20	25	TMBA-M20

Note: • Dimension ϕ d can be made to customer's specifications.
 • Because of the dimensional restriction of "E", standard CO- type centering plugs can not be used for the adapters shown in the above table. Special centering plugs applicable for the above adapters can be made to order on request.

MEMO

Grade

A

Insert

B

Ext. Toolholder

C

Int. Toolholder

D

Threading

E

Grooving

F

Miniature tool

G

Milling cutter

H

Endmill

I

Drilling tool

J

Tooling System

K

User's Guide

L

Index

M



High precision shoulder mill series with economical double-sided triangular inserts

Innovative insert

- Highly economical 6-corner double sided inserts.
- Long effective cutting edge allows shoulder milling with large depth of cut.
- Low cutting force at low depth of cut, and high machining stability at large depth of cut.
 - Concave cutting edge and large rake angle produce barrel-shape chips, resulting in excellent chip evacuation.
 - The design with wiper edge (front cutting edge) is also suitable for face milling.

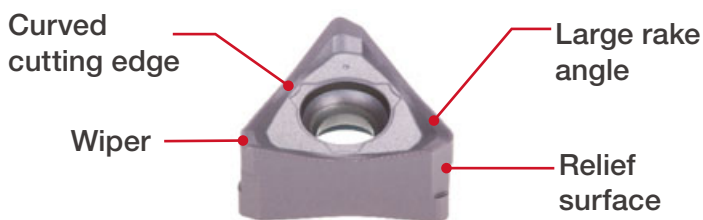

Comparison of surface roughness

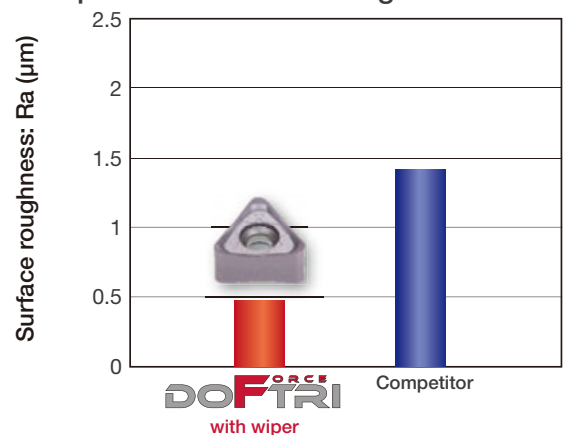

Reference pages: [H150](#) - [H153](#)



Excellent cutting performance with improved profitability

Economical 3 cutting-edge inserts



Drastically reduced cutting force

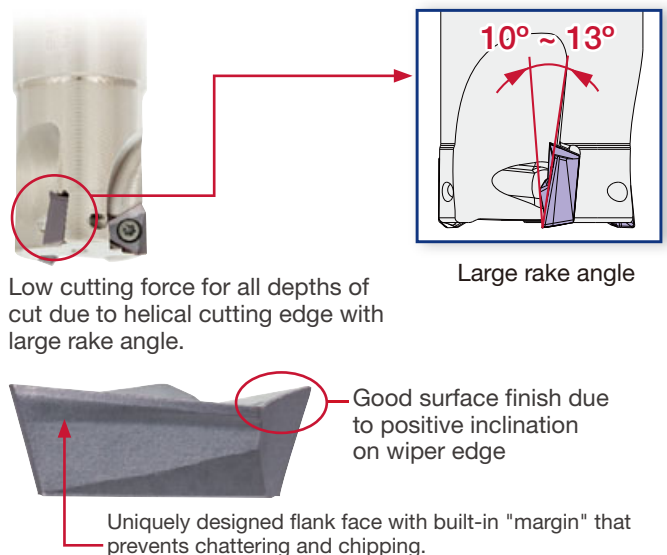

Applicable for a wide range of cutting conditions

Insert positioning in irregular pitch, combined with uniquely designed flank face of inserts, prevents chattering during machining.

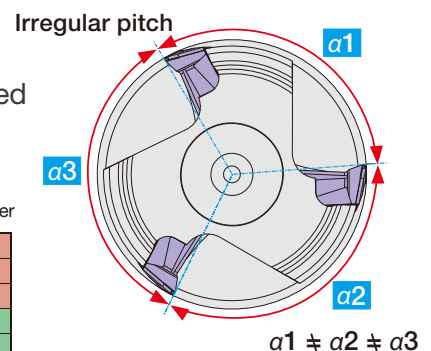

Cutting performance

ap (mm)	10	OK	0.05	0.10	0.15	0.20	0.25
	9						
	8						
	7						
	6						
	5						
	4						
	3						
	2						
	1						
Applicable area	fz (mm/t)						
TUNG-TRI							

ap (mm)	10	OK	0.05	0.10	0.15	0.20	0.25
	9						
	8						
	7						
	6						
	5						
	4						
	3						
	2						
	1						
Applicable area	fz (mm/t)						
Competitor							

Cutter : EPA10R032M32.0-03N (DC = 32 mm, CICT = 3)

Insert : TOMT100404PDER-MJ

Grade : AH3135

Workpiece : S55C (200 HB)

Cutting speed : $V_c = 150$ m/min

Width of cut : $a_e = 32$ mm

Machine : Vertical M/C, BT50

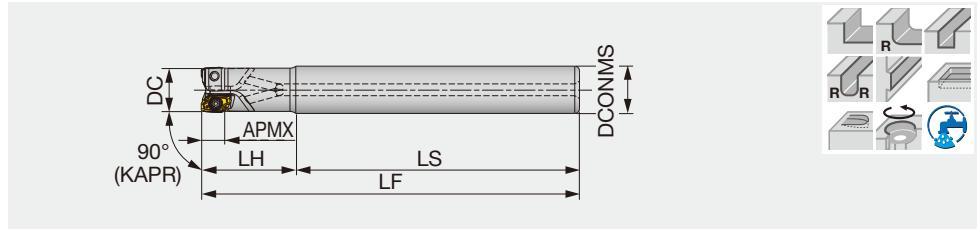

Designation	APMX	DC	CICT	DCONMS	LS	LH	LF	WT(kg)	Air hole	Insert
EPAV04M006C06.0R01	4	6	1	6	48	12	60	0.01	With	AVMT04...
EPAV04M008C08.0R02	4	8	2	8	48	12	60	0.02	With	AVMT04...
EPAV04M008C08.0R02L	4	8	2	8	60	20	80	0.03	With	AVMT04...
EPAV06M008C10.0R01	6	8	1	10	60	20	80	0.04	With	AVGT06...
EPAV04M010C10.0R02	4	10	2	10	60	20	80	0.04	With	AVMT04...
EPAV04M010C10.0R03	4	10	3	10	60	20	80	0.04	With	AVMT04...
EPAV04M010C10.0R02L	4	10	2	10	65	35	100	0.05	With	AVMT04...
EPAV06M010C10.0R02	6	10	2	10	60	20	80	0.04	With	AVGT06...
EPAV06M010C10.0R02L	6	10	2	10	65	35	100	0.06	With	AVGT06...
EPAV06M010C08.0R02L	6	10	2	8	80	20	100	0.04	With	AVGT06...
EPAV04M012C12.0R03	4	12	3	12	60	20	80	0.06	With	AVMT04...
EPAV04M012C12.0R04	4	12	4	12	60	20	80	0.06	With	AVMT04...
EPAV04M012C12.0R03L	4	12	3	12	85	35	120	0.09	With	AVMT04...
EPAV06M012C12.0R02	6	12	2	12	60	20	80	0.06	With	AVGT06...
EPAV06M012C12.0R03	6	12	3	12	60	20	80	0.06	With	AVGT06...
EPAV06M012C12.0R02L	6	12	2	12	85	35	120	0.09	With	AVGT06...
EPAV06M012C10.0R02L	6	12	2	10	100	20	120	0.07	With	AVGT06...
EPAV06M012C10.0R03	6	12	3	10	60	20	80	0.04	With	AVGT06...
EPAV12M012C12.0R01	11.5	12	1	12	60	25	85	0.06	With	AVM/GT12...
EPAV06M014C12.0R03	6	14	3	12	60	20	80	0.07	With	AVGT06...
EPAV06M014C12.0R03L	6	14	3	12	120	20	140	0.11	With	AVGT06...
EPAV04M016C16.0R04	4	16	4	16	70	20	90	0.12	With	AVMT04...
EPAV04M016C16.0R05	4	16	5	16	70	20	90	0.12	With	AVMT04...
EPAV04M016C16.0R04L	4	16	4	16	105	35	140	0.19	With	AVMT04...
EPAV12M016C16.0R02	11.5	16	2	16	60	25	85	0.12	With	AVM/GT12...
EPAV12M016C16.0R03	11.5	16	3	16	60	25	85	0.12	With	AVM/GT12...
EPAV12M016C16.0R02L	11.5	16	2	16	105	40	145	0.20	With	AVM/GT12...
EPAV06M016C16.0R03	6	16	3	16	70	20	90	0.12	With	AVGT06...
EPAV06M016C16.0R04	6	16	4	16	70	20	90	0.12	With	AVGT06...
EPAV06M016C16.0R03L	6	16	3	16	105	35	140	0.20	With	AVGT06...
EPAV06M018C16.0R03	6	18	3	16	70	20	90	0.13	With	AVGT06...
EPAV06M018C16.0R04	6	18	4	16	70	20	90	0.13	With	AVGT06...
EPAV06M018C16.0R03L	6	18	3	16	160	20	180	0.26	With	AVGT06...
EPAV06M020C20.0R04	6	20	4	20	70	30	100	0.23	With	AVGT06...
EPAV06M020C20.0R05	6	20	5	20	70	30	100	0.21	With	AVGT06...
EPAV06M020C20.0R04L	6	20	4	20	165	35	200	0.45	With	AVGT06...
EPAV06M020C16.0R04	6	20	4	16	80	30	110	0.17	With	AVGT06...
EPAV12M020C20.0R03	11.5	20	3	20	70	30	100	0.22	With	AVM/GT12...
EPAV12M020C20.0R04	11.5	20	4	20	70	30	100	0.21	With	AVM/GT12...
EPAV12M020C20.0R02L	11.5	20	2	20	135	50	185	0.41	With	AVM/GT12...
EPAV06M025C25.0R05	6	25	5	25	80	35	115	0.4	With	AVGT06...
EPAV06M025C25.0R06	6	25	6	25	80	35	115	0.4	With	AVGT06...
EPAV06M025C25.0R04L	6	25	4	25	160	40	200	0.72	With	AVGT06...
EPAV06M025C20.0R06	6	25	6	20	80	35	115	0.27	With	AVGT06...
EPAV12M025C25.0R04	11.5	25	4	25	80	35	115	0.38	With	AVM/GT12...
EPAV12M025C25.0R06	11.5	25	6	25	80	35	115	0.39	With	AVM/GT12...
EPAV12M025C25.0R03L	11.5	25	3	25	150	70	220	0.74	With	AVM/GT12...
EPAV06M032C32.0R08	6	32	8	32	80	40	120	0.7	With	AVGT06...
EPAV06M032C32.0R06L	6	32	6	32	155	45	200	1.2	With	AVGT06...
EPAV12M032C32.0R06	11.5	32	6	32	80	40	120	0.68	With	AVM/GT12...
EPAV12M032C32.0R08	11.5	32	8	32	80	40	120	0.68	With	AVM/GT12...
EPAV12M032C32.0R03L	11.5	32	3	32	175	80	255	1.47	With	AVM/GT12...

Reference pages: Inserts → **H126**, Standard cutting conditions → **H127 - H128**

SPARE PARTS

Designation	Clamping screw	Lubricant	Wrench
EPAV04M006C06.0R01	CSPB-1.8L3.3	M-1000	IP-6DB
EPAV04M008... - EPAV04M016...	CSPB-1.8L3.6	M-1000	IP-6DB
EPAV06M...	CSPB-2H	M-1000	IP-6DB
EPAV12M012C12.0R01	CSPB-2.5	M-1000	IP-8D
EPAV12M016C16.0R02	CSPB-2.5	M-1000	IP-8D
EPAV12M016C16.0R03	CSPB-2.5S	M-1000	IP-8D
EPAV12M016C16.0R02L	CSPB-2.5	M-1000	IP-8D
EPAV12M020C20.0R03	CSPB-2.5	M-1000	IP-8D
EPAV12M020C20.0R04	CSPB-2.5S	M-1000	IP-8D
EPAV12M020C20.0R02L	CSPB-2.5	M-1000	IP-8D
EPAV12M025C25.0R04	CSPB-2.5	M-1000	IP-8D
EPAV12M025C25.0R06	CSPB-2.5S	M-1000	IP-8D
EPAV12M025C25.0R03L	CSPB-2.5	M-1000	IP-8D
EPAV12M032C32.0R06	CSPB-2.5	M-1000	IP-8D
EPAV12M032C32.0R08	CSPB-2.5S	M-1000	IP-8D
EPAV12M032C32.0R03L	CSPB-2.5	M-1000	IP-8D

Recommended clamping torque:

CSPB-1.8L3.3, CSPB-1.8L3.6 = 0.5 N-m, CSPB-2H = 0.7 N-m, CSPB-2.5, CSPB-2.5S = 1.3 N-m

TUNGFORCE

HPAV06-S

Square shoulder endmill, modular type (TungMeister), with screw clamp system

GAMP = +6.9° ~ +7.6°, GAMF = -35.2° ~ -32.4°

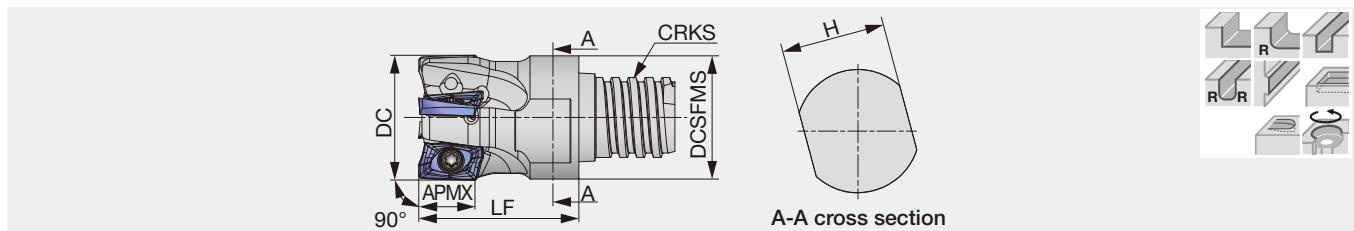

Designation	APMX	DC	CICT	LF	H	DCSFMS	CRKS	WT(kg)	Insert
HPAV06M010S05R02	6	10	2	10	8	8	S05	0.01	AVGT06...
HPAV06M010S06R02	6	10	2	16	8	9.8	S06	0.01	AVGT06...
HPAV06M012S08R02	6	12	2	18	10	11.7	S08	0.02	AVGT06...
HPAV06M012S08R03	6	12	3	18	10	11.7	S08	0.02	AVGT06...
HPAV06M016S10R03	6	16	3	20	13	15.4	S10	0.03	AVGT06...
HPAV06M016S10R04	6	16	4	20	13	15.4	S10	0.03	AVGT06...

For connections between metric shank and TungMeister thread, please use VAD-M type connector

SPARE PARTS

Designation	Clamping screw	Lubricant	Wrench
HPAV06M...	CSPB-2H	M-1000	IP-6DB

Recommended clamping torque: 0.7 N-m

Designation	Wrench*
HPAV06M010S...	KEYV-S06
HPAV06M012S...	KEYV-S08
HPAV06M016S...	KEYV-S10

*sold separately

Reference pages: Inserts → **H126**, Standard cutting conditions → **H127 - H128**, TungMeister shank → **I100**





HPAV06/12-M

Square shoulder endmill, modular type (TungFlex), with screw clamp system

HPAV06-M: GAMP = +6.9°~ +7.6°, GAMF = -35.2°~ -32.4°
 HPAV12-M: GAMP = +6°~ +7.6°, GAMF = -37.1°~ -32.4°

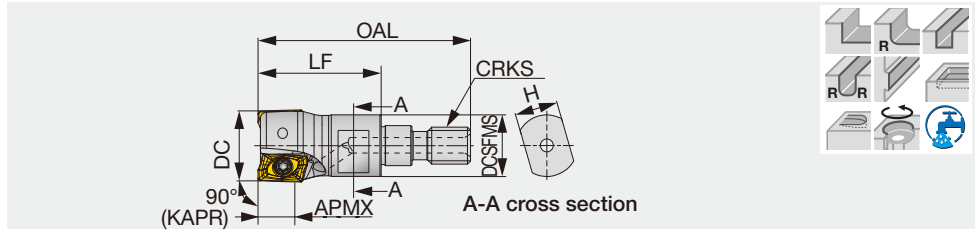

Designation	APMX	DC	CICT	OAL	LF	H	DCSFMS	CRKS	WT(kg)	Air hole	Insert
HPAV06M010M06R02	6	10	2	34.5	20	7	9.5	M6	0.01	Without	AVGT06...
HPAV06M012M06R02	6	12	2	34.5	20	7	10	M6	0.01	Without	AVGT06...
HPAV06M012M06R03	6	12	3	34.5	20	7	10	M6	0.01	Without	AVGT06...
HPAV06M016M08R03	6	16	3	42	25	10	13	M8	0.03	Without	AVGT06...
HPAV06M016M08R04	6	16	4	42	25	10	13	M8	0.03	Without	AVGT06...
HPAV12M016M08R02	11.5	16	2	42	25	10	14.5	M8	0.03	With	AVM/GT12...
HPAV12M016M08R03	11.5	16	3	42	25	10	14.5	M8	0.03	With	AVM/GT12...
HPAV12M020M10R03	11.5	20	3	49	30	15	17.8	M10	0.06	With	AVM/GT12...
HPAV12M020M10R04	11.5	20	4	49	30	15	17.8	M10	0.05	With	AVM/GT12...
HPAV12M025M12R04	11.5	25	4	57	35	17	23	M12	0.1	With	AVM/GT12...
HPAV12M025M12R06	11.5	25	6	57	35	17	23	M12	0.1	With	AVM/GT12...
HPAV12M032M16R06	11.5	32	6	63	40	22	28.8	M16	0.21	With	AVM/GT12...
HPAV12M032M16R08	11.5	32	8	63	40	22	28.8	M16	0.21	With	AVM/GT12...
HPAV12M040M16R06	11.5	40	6	63	40	22	28.8	M16	0.25	With	AVM/GT12...
HPAV12M040M16R08	11.5	40	8	63	40	22	28.8	M16	0.24	With	AVM/GT12...

SPARE PARTS



Designation	Clamping screw	Lubricant	Wrench
HPAV06M...	CSPB-2H	M-1000	IP-6DB
HPAV12M016M08R02	CSPB-2.5	-	IP-8D
HPAV12M016M08R03	CSPB-2.5S	-	IP-8D
HPAV12M020M10R03	CSPB-2.5	-	IP-8D
HPAV12M020M10R04	CSPB-2.5S	-	IP-8D
HPAV12M025M12R04	CSPB-2.5	-	IP-8D
HPAV12M025M12R06	CSPB-2.5S	-	IP-8D
HPAV12M032M16R06	CSPB-2.5	-	IP-8D
HPAV12M032M16R08	CSPB-2.5S	-	IP-8D
HPAV12M040M16R06	CSPB-2.5	-	IP-8D
HPAV12M040M16R08	CSPB-2.5	-	IP-8D

Recommended clamping torque: 1.3 N·m

Square shoulder mill, bore type, with screw clamp system

TPAV06: GAMP = +7.7°, GAMF = -29.8°
TPAV12: GAMP = +6° ~ +7.6°, GAMF = -37.1° ~ -32.4°

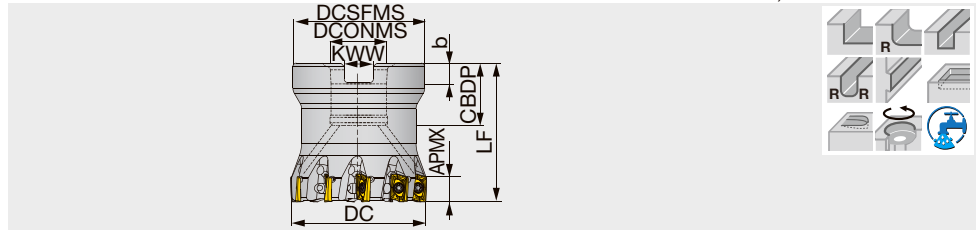

Designation	APMX	DC	CICT	DCSFMS	DCONMS	CBDP	LF	KWW	b	WT(kg)	Insert
TPAV06M040B16.0R10	6	40	10	38	16	18	40	8.4	5.6	0.24	AVGT06...
TPAV12M050B22.0R08	11.5	50	8	47	22	20	40	10.4	6.3	0.37	AVM/GT12...
TPAV12M050B22.0R12	11.5	50	12	47	22	20	40	10.4	6.3	0.37	AVM/GT12...
TPAV12M063B22.0R08	11.5	63	8	47	22	20	40	10.4	6.3	0.52	AVM/GT12...
TPAV12M063B22.0R14	11.5	63	14	47	22	20	40	10.4	6.3	0.54	AVM/GT12...

SPARE PARTS



Designation	Clamping screw	Lubricant	Wrench	Center bolt
TPAV06M040B16.0R10	CSPB-2H	M-1000	IP-6DB	CM8X30H
TPAV12M...	CSPB-2.5	-	IP-8D	CM10x30H

Recommended clamping torque: CSPB-2H = 0.7 N-m, CSPB-2.5 = 1.3 N-m



- High Feed Milling
- Face Milling
- Shoulder Milling
- Slot Milling
- Profile Milling
- Chamfering, Counterbore
- Finish Face Milling
- Approach angle
- 7°-25°
- 41°-45°
- 60°-70°
- 85-88°
- 90°
- Others

INSERT

AVMT04-MM

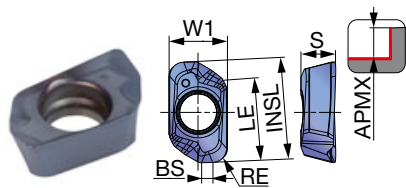

AVGT06-MJ

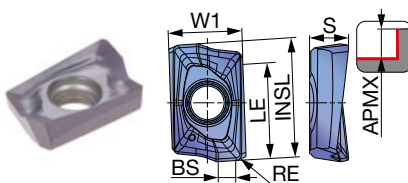

AVGT06-AJ

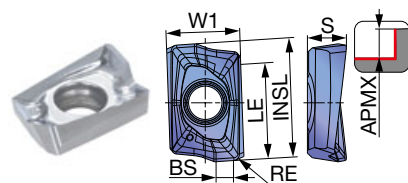

AVMT-12MM

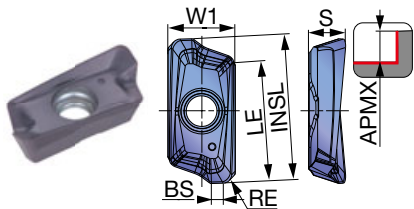

AVGT12-AM

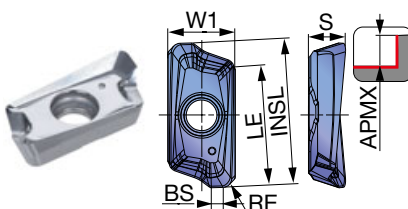

P Steel	☆	☆	★	★													
M Stainless		☆	☆	★	☆												
K Cast iron	★				☆												
N Non-ferrous						★											
S Superalloys	★	★		★													
H Hard materials	★																

★ : First choice
☆ : Second choice

Designation	RE	APMX	Coated						Carbide	W1	INSL	S	BS	LE
			AH120	AH130	AH3135	AH3225	T1215	T3225	KS05F					
AVMT040204PPER-MM	0.4	4	●		●					3.5	6.05	2.1	1	4.4
AVMT040208PPER-MM	0.8	4	●		●					3.5	6.05	2.1	0.6	4.4
AVGT060300PBER-MJ	0.0	6			●	●				5	8	2.7	1.6	6.5
AVGT060302PBER-MJ	0.2	6	●	●	●	●				5	8	2.7	1.5	6.5
AVGT060304PBER-MJ	0.4	6	●	●	●	●				5	8	2.7	1.3	6.5
AVGT060308PBER-MJ	0.8	6	●	●	●	●				5	8	2.6	0.9	6.5
AVGT060300PBFR-AJ	0.0	6						●		5	8	2.7	1.6	6.5
AVGT060302PBFR-AJ	0.2	6						●		5	8	2.7	1.5	6.5
AVGT060304PBFR-AJ	0.4	6						●		5	8	2.7	1.3	6.5
AVGT060308PBFR-AJ	0.8	6						●		5	8	2.6	0.9	6.5
AVMT120404PDER-MM	0.4	11.5	●			●	●	●		6.6	14.2	3.6	1.5	11.8
AVMT120408PDER-MM	0.8	11.5	●			●	●	●		6.6	14.2	3.6	1.1	11.8
AVMT120412PDER-MM	1.2	11.5	●			●	●	●		6.6	14.2	3.6	0.7	11.8
AVMT120416PDER-MM	1.6	11.5	●			●	●	●		6.6	14.2	3.6	0.3	11.8
AVMT120420PDER-MM	2	10.5	●			●	●	●		6.6	12.7	3.4	1.2	11.1
AVMT120430PDER-MM	3	10.5	●			●	●	●		6.6	12.7	3.4	0.2	11.1
AVGT120404PDFR-AM	0.4	11.5						●		6.6	14.2	3.6	1.5	11.8
AVGT120408PDFR-AM	0.8	11.5						●		6.6	14.2	3.6	1.1	11.8

● : Line up

STANDARD CUTTING CONDITIONS

EPAV04

ISO	Workpiece materials	Hardness	Priority	Grades	Cutting speed Vc (m/min)	Feed per tooth fz (mm/t)
P	Low carbon steel S15C, SS400, etc. C15E, C15E4, E275A, etc.	- 200 HB	First choice	AH3225	100 - 300	0.05 - 0.12
	Carbon steel and alloy steel S55C, SCM440, etc. C55, 42CrMo4, etc.	- 300 HB	First choice	AH3225	100 - 250	0.05 - 0.12
	Prehardened steel NAK80, PX5, etc.	30 - 40 HRC	First choice	AH3225	100 - 200	0.05 - 0.1
M	Stainless steel SUS304, SUS316, etc. X5CrNi18-9, X5CrNiMo17-12-3, etc.	- 200 HB	First choice	AH3225	80 - 180	0.05 - 0.1
K	Grey cast iron FC250, FC300, etc. 250, 300, etc.	150 - 250 HB	First choice	AH120	100 - 300	0.05 - 0.12
	Ductile cast iron FCD400, FCD600, etc. GGG60, 600-3, etc.	150 - 250 HB	First choice	AH120	100 - 250	0.05 - 0.12
S	Titanium alloys Ti-6Al-4V, etc.	- 40 HRC	First choice	AH3225	20 - 60	0.04 - 0.07
	Superalloys Inconel 718, etc.	- 40 HRC	First choice	AH120	20 - 40	0.04 - 0.07
H	Hardened steel	SKD61, X40CrMoV5-1, etc.	40 - 50 HRC	First choice	AH120	50 - 150
		SKD11, X153CrMoV12, etc.	50 - 60 HRC	First choice	AH120	40 - 70

EPAV06, HPAV06-M, HPAV06-S, TPAV06

ISO	Workpiece materials	Hardness	Priority	Grades	Cutting speed Vc (m/min)	Feed per tooth fz (mm/t)
P	Low carbon steel S15C, SS400, etc. C15E, C15E4, E275A, etc.	- 200 HB	First choice	AH3225	230 - 430	0.07 - 0.12
	Carbon steel and alloy steel S55C, SCM440, etc. C55, 42CrMo4, etc.	- 300 HB	First choice	AH3225	150 - 350	0.07 - 0.12
	Prehardened steel NAK80, PX5, etc.	30 - 40 HRC	First choice	AH3225	100 - 230	0.07 - 0.12
M	Stainless steel SUS304, SUS316, etc. X5CrNi18-9, X5CrNiMo17-12-3, etc.	- 200 HB	First choice	AH3135	150 - 220	0.06 - 0.1
K	Grey cast iron FC250, FC300, etc. 250, 300, etc.	150 - 250 HB	First choice	AH120	200 - 330	0.07 - 0.12
	Ductile cast iron FCD400, FCD600, etc. GGG60, 600-3, etc.	150 - 250 HB	First choice	AH120	150 - 240	0.07 - 0.12
N	Aluminium alloys Si < 13%	-	First choice	KS05F	650 - 1000	0.07 - 0.12
	Aluminium alloys Si ≥ 13%	-	First choice	KS05F	100 - 230	0.04 - 0.12
S	Titanium alloys Ti-6Al-4V, etc.	- 40 HRC	First choice	AH130	40 - 90	0.04 - 0.1
	Superalloys Inconel 718, etc.	- 40 HRC	First choice	AH130	45 - 65	0.04 - 0.09
H	Hardened steel	SKD61, X40CrMoV5-1, etc.	40 - 50 HRC	First choice	AH120	45 - 70
		SKD11, X153CrMoV12, etc.	50 - 60 HRC	First choice	AH120	40 - 65

Grade
Insert
Toolholder
Ext. Toolholder
Int. Toolholder
Threading
Grooving
Miniature tool
Milling cutter
Endmill
Drilling tool
Tooling System
User's Guide
Index



STANDARD CUTTING CONDITIONS

EPAV12, HPAV12-M, TPAV12

ISO	Workpiece materials	Hardness	Priority	Grades	Cutting speed Vc (m/min)	Feed per tooth fz (mm/t)	
P	Low carbon steel S15C, SS400, etc. C15E, C15E4, E275A, etc.	- 200 HB	First choice	AH3225	100 - 300	0.06 - 0.22	
		- 200 HB	Wear resistance	T3225	200 - 400	0.06 - 0.18	
	Carbon steel and alloy steel S55C, SCM440, etc. C55, 42CrMo4, etc.	- 300 HB	First choice	AH3225	100 - 250	0.06 - 0.22	
		- 300 HB	Wear resistance	T3225	200 - 400	0.06 - 0.18	
	Prehardened steel NAK80, PX5, etc.	30 - 40 HRC	First choice	AH3225	100 - 200	0.06 - 0.22	
		30 - 40 HRC	Wear resistance	T3225	200 - 400	0.06 - 0.15	
M	Stainless steel SUS304, SUS316, etc. X5CrNi18-9, X5CrNiMo17-12-3, etc.	- 200 HB	First choice	AH3225	80 - 180	0.07 - 0.2	
K	Grey cast iron FC250, FC300, etc. GG25, GG30, etc. 250, 300, etc.	150 - 250 HB	First choice	AH120	100 - 300	0.05 - 0.18	
		150 - 250 HB	Wear resistance	T1215	200 - 400	0.05 - 0.12	
	Ductile cast iron FCD400, FCD600, etc. GGG60, 600-3, etc.	150 - 250 HB	First choice	AH120	100 - 250	0.05 - 0.18	
		150 - 250 HB	Wear resistance	T1215	150 - 300	0.05 - 0.12	
N	Aluminum alloys Si < 13%	-	First choice	KS05F	300 - 1500	0.05 - 0.32	
	Aluminum alloys Si ≥ 13%	-	First choice	KS05F	100 - 200	0.05 - 0.32	
S	Titanium alloys Ti-6Al-4V, etc.	- 40 HRC	First choice	AH3225	20 - 60	0.04 - 0.15	
	Superalloys Inconel 718, etc.	- 40 HRC	First choice	AH120	20 - 40	0.04 - 0.15	
H	Hardened steel	SKD61, X40CrMoV5-1, etc.	40 - 50 HRC	First choice	AH120	50 - 150	0.04 - 0.07
		SKD11, X153CrMoV12, etc.	50 - 60 HRC	First choice	AH120	40 - 70	0.04 - 0.07

Cautionary point in modifying cutter bodies

When using inserts with corner radius RE ≥ 2 mm, standard cutter bodies have to be modified "R". (EPAV12, TPAV12, HPAV12)

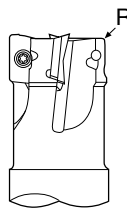

Corner radius RE (mm)	The dimension of modifying (mm)
0.4 - 1.6	Unnecessary
2 - 3	2

MACHINING APPLICATIONS

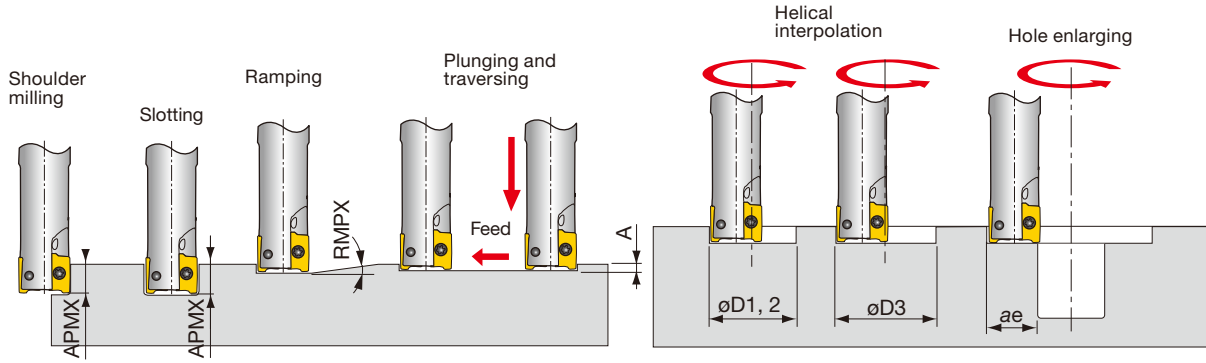

Designation	DC	Max. depth of cut		Max. plunging	Min. machining	Max. machining		Max. cutting width in enlarging
		APMX	RMPX			øD1	øD3*	
EPAV04M006C06.0R01	6	4	0.4°	0.03	9.3	11.6	9.9	5.5
EPAV04M008C08.0R02	8	4	0.5°	0.04	12.7	15.6	13.6	7.5
EPAV04M008C08.0R02L	8	4	0.5°	0.04	12.7	15.6	13.6	7.5
EPAV04M010C10.0R02	10	4	4.1°	0.4	15.3	19.6	17.5	9.5
EPAV04M010C10.0R03	10	4	1.7°	0.2	16.1	19.6	17.5	9.5
EPAV04M010C10.0R02L	10	4	4.1°	0.4	16.1	19.6	17.5	9.5
EPAV04M012C12.0R03	12	4	2.7°	0.4	19.3	23.6	21.5	11.5
EPAV04M012C12.0R04	12	4	1.3°	0.2	20.1	23.6	21.5	11.5
EPAV04M012C12.0R03L	12	4	2.7°	0.4	19.3	23.6	21.5	11.5
EPAV04M016C16.0R04	16	4	2°	0.4	27.2	31.6	29.5	15.5
EPAV04M016C16.0R05	16	4	2°	0.4	27.2	31.6	29.5	15.5
EPAV04M016C16.0R04L	16	4	2°	0.4	27.2	31.6	29.5	15.5
EPAV06M008...	8	6	-	-	-	-	-	-
EPAV/HPAV06M010...	10	6	3°	0.3	15	19	18	9.5
EPAV/HPAV06M012...	12	6	3°	0.3	18	23	22	11.5
EPAV/HPAV06M014...	14	6	2.3°	0.3	22	27	26	13.5
EPAV/HPAV06M016...	16	6	2°	0.3	28	31	30	15.5
EPAV/HPAV06M018...	18	6	1.6°	0.3	30	35	34	17.5
EPAV/HPAV06M020...	20	6	1.4°	0.3	34	39	38	19.5
EPAV/HPAV06M025...	25	6	1.1°	0.3	44	49	48	24.5
EPAV/HPAV06M032...	32	6	0.8°	0.3	58	63	62	31.5
TPAV06M040...	40	6	0.6°	0.3	74	79	78	39.5
EPAV12M012...	12	11.5	4.5°	0.5	17.8	23	22	11
E/HPAV12M016...	16	11.5	3.5°	0.5	25.3	31	30	15
E/HPAV12M020...	20	11.5	3°	0.5	33	39	38	19
E/HPAV12M025...	25	11.5	2.5°	0.5	42.6	49	48	24
E/HPAV12M032...	32	11.5	2°	0.5	56.4	63	62	31
HPAV12M040...	40	11.5	2°	0.5	71.5	78	77	39
TPAV12M050...	50	11.5	2°	0.5	90.4	99	98	49
TPAV12M063...	63	11.5	1.8°	0.5	115.6	125	124	62

*Flat bottom hole

When clamping the insert, please confirm that there is no gap between the cutter body and the insert as shown in the picture.

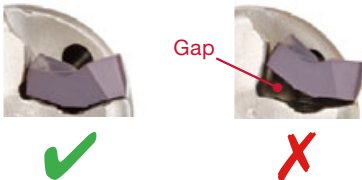

Grade
Insert
Ext. Toolholder
Int. Toolholder
Threading
Grooving
Miniature tool
Milling cutter
Endmill
Drilling tool
Tooling System
User's Guide
Index

A
B
C
D
E
F
G
H
I
J
K
L
M



High precision square shoulder endmill, shank type, with screw clamp system

EPA04: GAMP = +12.1°~ +12.2°, GAMF = -14.2°~ -18.3°, EPA06: GAMP = +8.5°~ +11.5°, GAMF = -5.5°~ -12.5°, EPA10: GAMP = +9.5°~ +11°, GAMF = -4.5°~ -0.5°, EPA15: GAMP = +12°~ +13.5°, GAMF = -6°~ -3.5°

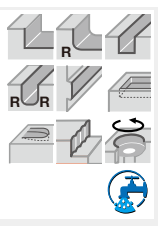
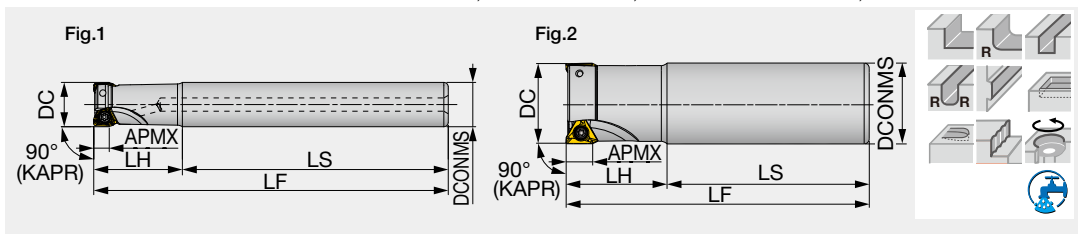

Designation	APMX	DC	CICT	DCONMS	LS	LH	LF	WT(kg)	Air hole	Insert	Fig.
EPA04R008M08.0-01	3.5	8	1	8	48	12	60	0.02	with	TOMT04...	1
EPA04R010M10.0-02	3.5	10	2	10	60	20	80	0.04	with	TOMT04...	1
EPA04R010M10.0-02L	3.5	10	2	10	65	35	100	0.05	with	TOMT04...	1
EPA04R012M12.0-02	3.5	12	2	12	60	20	80	0.06	with	TOMT04...	1
EPA04R012M12.0-03	3.5	12	3	12	60	20	80	0.06	with	TOMT04...	1
EPA04R012M12.0-02L	3.5	12	2	12	85	35	120	0.09	with	TOMT04...	1
EPA04R016M16.0-03	3.5	16	3	16	70	20	90	0.12	with	TOMT04...	1
EPA04R016M16.0-04	3.5	16	4	16	70	20	90	0.12	with	TOMT04...	1
EPA04R016M16.0-03L	3.5	16	3	16	105	35	140	0.19	with	TOMT04...	1
EPA04R020M20.0-04	3.5	20	4	20	70	30	100	0.21	with	TOMT04...	1
EPA04R020M20.0-05	3.5	20	5	20	70	30	100	0.21	with	TOMT04...	1
EPA04R020M20.0-04L	3.5	20	4	20	165	35	200	0.44	with	TOMT04...	1
EPA04R025M25.0-05	3.5	25	5	25	80	35	115	0.39	with	TOMT04...	1
EPA04R025M25.0-06	3.5	25	6	25	80	35	115	0.39	with	TOMT04...	1
EPA04R025M25.0-04L	3.5	25	4	25	160	40	200	0.7	with	TOMT04...	1
EPA06R012M16.0-01N	6	12	1	16	50	18	68	0.09	without	TO*T06...	2
EPA06R016M16.0-02N	6	16	2	16	60	24	84	0.12	without	TO*T06...	2
EPA06R016M16.0-02L	6	16	2	16	105	40	145	0.2	with	TO*T06...	2
EPA06R018M16.0-02N	6	18	2	16	60	24	84	0.13	without	TO*T06...	2
EPA06R018M16.0-02L	6	18	2	16	115	30	145	0.21	with	TO*T06...	2
EPA06R020M16.0-02N	6	20	2	16	60	30	90	0.14	without	TO*T06...	2
EPA06R020M20.0-02N	6	20	2	20	70	30	100	0.23	without	TO*T06...	2
EPA06R020M20.0-03N	6	20	3	20	70	30	100	0.22	without	TO*T06...	2
EPA06R020M20.0-02L	6	20	2	20	135	50	185	0.41	with	TO*T06...	2
EPA06R022M20.0-02N	6	22	2	20	70	30	100	0.23	without	TO*T06...	2
EPA06R022M20.0-03N	6	22	3	20	70	30	100	0.23	without	TO*T06...	2
EPA06R022M20.0-02L	6	22	2	20	145	40	185	0.42	with	TO*T06...	2
EPA06R025M25.0-03N	6	25	3	25	80	35	115	0.41	without	TO*T06...	2
EPA06R025M25.0-04N	6	25	4	25	80	35	115	0.41	without	TO*T06...	2
EPA06R025M25.0-02L	6	25	2	25	150	70	220	0.78	with	TO*T06...	2
EPA06R028M25.0-03N	6	28	3	25	80	35	115	0.42	without	TO*T06...	2
EPA06R028M25.0-04N	6	28	4	25	80	35	115	0.42	without	TO*T06...	2
EPA06R028M25.0-02L	6	28	2	25	180	40	220	0.8	with	TO*T06...	2
EPA10R025M25.0-02N	10	25	2	25	80	35	115	0.38	without	TO*T10...	2
EPA10R025M25.0-02L	10	25	2	25	150	70	220	0.75	with	TO*T10...	2
EPA10R028M25.0-02N	10	28	2	25	80	35	115	0.39	without	TO*T10...	2
EPA10R028M25.0-02L	10	28	2	25	185	35	220	0.78	with	TO*T10...	2
EPA10R032M32.0-02N	10	32	2	32	80	40	120	0.66	without	TO*T10...	2
EPA10R032M32.0-03N	10	32	3	32	80	40	120	0.65	without	TO*T10...	2
EPA10R032M32.0-02L	10	32	2	32	175	80	255	1.46	with	TO*T10...	2
EPA10R035M32.0-02N	10	35	2	32	80	40	120	0.7	without	TO*T10...	2
EPA10R035M32.0-03N	10	35	3	32	80	40	120	0.68	without	TO*T10...	2
EPA10R035M32.0-02L	10	35	2	32	215	40	255	1.52	with	TO*T10...	2
EPA10R040M32.0-03N	10	40	3	32	80	40	120	0.72	without	TO*T10...	2
EPA10R040M32.0-04N	10	40	4	32	80	40	120	0.73	without	TO*T10...	2
EPA10R040M32.0-02L	10	40	2	32	205	50	255	1.57	with	TO*T10...	2
EPA15R040M32.0-03N	15	40	3	32	80	40	120	0.73	without	TO*T15...	2
EPA15R040M32.0-02L	15	40	2	32	205	50	255	1.56	with	TO*T15...	2
EPA15R050M32.0-04N	15	50	4	32	80	40	120	0.83	without	TO*T15...	2
EPA15R050M42.0-02L	15	50	2	42	310	50	360	3.84	with	TO*T15...	2

Reference pages: Inserts → [H136](#), Standard cutting conditions → [H137 - H138](#)

SPARE PARTS

Designation	Clamping screw	Grip	Lubricant	Wrench	Torx bit
EPA04R008M08.0-01	CSPB-1.8L3.3	IP-6DB	-	-	-
EPA04R010 - 025...	CSPB-1.8L3.6	IP-6DB	-	-	-
EPA06R012 - 018M...	CSTB-2.5S	-	M-1000	T-8D	-
EPA06R020 - 028M...	CSTB-2.5	-	M-1000	T-8D	-
EPA10...	SR14-562/S	SW6-SD	M-1000	-	BLDT10/S7
EPA15...	TS45120I	H-TB2W	M-1000	-	BT20S

Recommended clamping torque: CSPB-1.8L3.6 = 0.5 N·m, CSTB-2.5S, CSTB-2.5 = 1.3 N·m, SR14-562/S = 3.5 N·m, CSPB-1.8L3.3, TS45120I = 5 N·m

TUNG-TRI

HPA06/10-M

High precision square shoulder endmill, modular type (TungFlex)

HPA06-M: GAMP = +8.5°~ +11.5°, GAMF = -12.5°~ -5.5°
HPA10-M: GAMP = +9.5°~ +11°, GAMF = -4.5°~ -0.5°

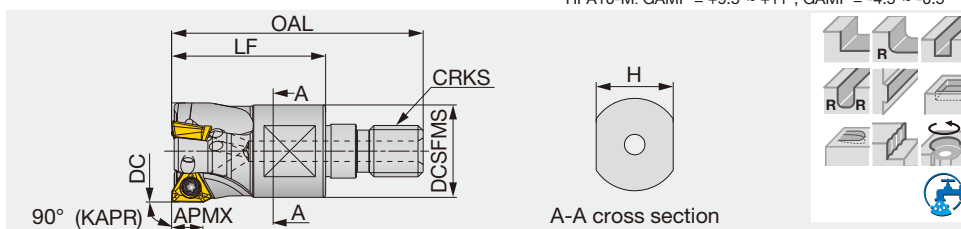

Designation	APMX	DC	CICT	OAL	LF	H	DCSFMS	CRKS	WT(kg)	Air hole	Insert
HPA06R016MM08-02	6	16	2	42	25	10	13	M8	0.03	with	TO*T06...
HPA06R020MM10-03	6	20	3	49	30	15	18	M10	0.06	with	TO*T06...
HPA06R025MM12-04	6	25	4	57	35	17	21	M12	0.1	with	TO*T06...
HPA06R032MM16-05	6	32	5	63	40	22	29	M16	0.20	with	TO*T06...
HPA10R025MM12-02	10	25	2	57	35	17	21	M12	0.08	with	TO*T10...
HPA10R032MM16-03	10	32	3	63	40	22	29	M16	0.18	with	TO*T10...

SPARE PARTS

Designation	Clamping screw	Grip	Lubricant	Wrench	Torx bit
HPA06R016MM08-02	CSTB-2.5S	-	M-1000	T-8D	-
HPA06R020 - 032MM...	CSTB-2.5	-	M-1000	T-8D	-
HPA10...	SR14-562/S	SW6-SD	M-1000	-	BLDT10/S7

Recommended clamping torque: CSTB-2.5, CSTB-2.5S = 1.3 N·m, SR14-562/S = 3.5 N·m

Reference pages: Inserts → **H136**, Standard cutting conditions → **H137 - H138**, TungFlex → **H036 - H037**





TUNG-TRI

TPA06/10/15



High precision square shoulder mill, with screw clamp system

TPA06: GAMP = +8.5°~ +11.5°, GAMF = -5.5°~ -12.5°
 TPA10: GAMP = +9.5°~ +11°, GAMF = -4.5°~ -0.5°
 TPA15: GAMP = +12°~ +13.5°, GAMF = -6°~ -3.5°

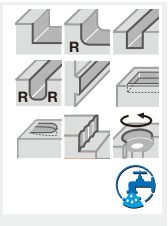
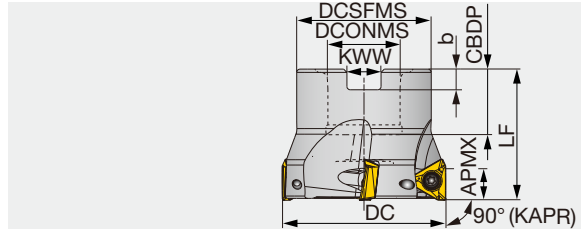

Designation	APMX	DC	CICT	DCSFMS	DCONMS	CBDP	LF	b	KWW	WT(kg)	Air hole	Insert
TPA06R032M16.0E05	6	32	5	30	16	18	40	5.6	8.4	0.14	with	TO*T06...
TPA06R040M16.0E06	6	40	6	35	16	18	40	5.6	8.4	0.22	with	TO*T06...
TPA10R040M16.0E04	10	40	4	35	16	18	40	5.6	8.4	0.2	with	TO*T10...
TPA06R050M22.0E08	6	50	8	41	22	20	40	6.3	10.4	0.31	with	TO*T06...
TPA10R050M22.0E04	10	50	4	41	22	20	40	6.3	10.4	0.31	with	TO*T10...
TPA15R050M22.0E04	15	50	4	41	22	20	40	6.3	10.4	0.27	with	TO*T15...
TPA10R063M22.0E06	10	63	6	41	22	20	40	6.3	10.4	0.51	with	TO*T10...
TPA15R063M22.0E05	15	63	5	41	22	20	40	6.3	10.4	0.41	with	TO*T15...
TPA10R080M25.4-07	10	80	7	58	25.4	26	50	6	9.5	1.04	with	TO*T10...
TPA10R080M27.0E07	10	80	7	58	27	22	50	7	12.4	1.04	with	TO*T10...
TPA15R080M25.4-06	15	80	6	46	25.4	26	50	6	9.5	0.83	with	TO*T15...
TPA15R080M27.0E06	15	80	6	50	27	22	50	7	12.4	0.86	with	TO*T15...
TPA10R100M31.7-08	10	100	8	70	31.75	32	63	8	12.7	2.02	with	TO*T10...
TPA10R100M32.0E08	10	100	8	60	32	28.5	50	8	14.4	2.02	with	TO*T10...
TPA15R100M31.7-07	15	100	7	60	31.75	32	50	8	12.7	1.3	with	TO*T15...
TPA15R100M32.0E07	15	100	7	60	32	28.5	50	8	14.4	1.27	with	TO*T15...
TPA15R125M38.1-08	15	125	8	80	38.1	38	63	10	15.9	2.7	with	TO*T15...
TPA15R125M40.0E08	15	125	8	71	40	32	63	9	16.4	2.47	with	TO*T15...
TPA15R160M40.0E10N	15	160	10	100	40	32	63	9	16.4	4.77	without	TO*T15...
TPA15R160M50.8-10N	15	160	10	100	50.8	46	63	11	19	4.4	without	TO*T15...



SPARE PARTS



Designation	Clamping screw	Grip 1	Grip 2	Lubricant	Center bolt 1	Center bolt 2	Wrench	Torx bit
TPA06R032M16.0E05	CSTB-2.5	-	-	M-1000	-	FSHM8-30H	T-8D	-
TPA06R040M16.0E06	CSTB-2.5	-	-	M-1000	-	CM8X30H	T-8D	-
TPA06R050M22.0E08	CSTB-2.5	-	-	M-1000	-	CM10X30H	T-8D	-
TPA10R040M16.0E04	SR14-562/S	-	SW6-SD	M-1000	-	CM8X30H	-	BLDT10/S7
TPA10R050, 063M...	SR14-562/S	-	SW6-SD	M-1000	-	CM10X30H	-	BLDT10/S7
TPA10R080M...	SR14-562/S	-	SW6-SD	M-1000	-	CM12X30H	-	BLDT10/S7
TPA10R100M...	SR14-562/S	-	SW6-SD	M-1000	-	CM16X40H	-	BLDT10/S7
TPA15R050M22.0E04	TS45120I	H-TB2W	-	M-1000	-	-	-	BT20S
TPA15R063M22.0E05	TS45120I	H-TB2W	-	M-1000	-	-	-	BT20S
TPA15R080M...	TS45120I	H-TB2W	-	M-1000	-	-	-	BT20S
TPA15R100M...	TS45120I	H-TB2W	-	M-1000	TMBA-M16H	TMBA-M16H	-	BT20S
TPA15R125M...	TS45120I	H-TB2W	-	M-1000	TMBA-M20H	TMBA-M20H	-	BT20M
TPA15R160M...	TS45120I	H-TB2W	-	M-1000	-	-	-	BT20M

Recommended clamping torque: CSTB-2.5 = 1.3 N·m, SR14-562/S = 3.5 N·m, TS45120I = 5 N·m

Reference pages: Inserts → **H136**, Standard cutting conditions → **H137 - H138**

Square shoulder mill for roughing, with screw clamp system

GAMP = +9.5° ~ +11°, GAMF = -4.5° ~ -0.5°

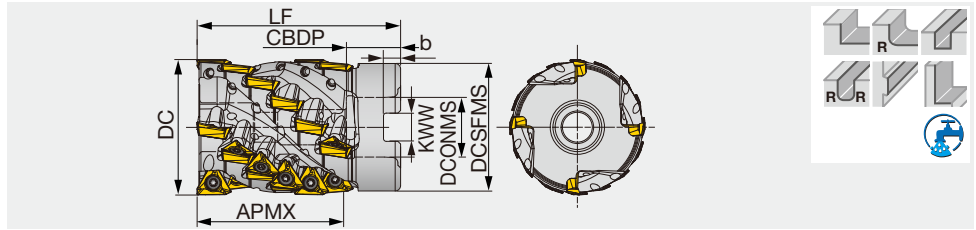

Designation	APMX	DC	ZEPF	CICT	DCSFMS	DCONMS	CBDP	LF	b	KWW	WT(kg)	Air hole	Insert
TLA10R050L054M22.0E04	54	50	4	24	47	22	20	75	6.3	10.4	0.64	with	TO*T10...
TLA10R063L054M25.4-04	54	63	4	24	60	25.4	26	80	6	9.5	1.26	with	TO*T10...
TLA10R063L054M27.0E04	54	63	4	24	60	27	22	80	7	12.4	1.25	with	TO*T10...

Note: Coolant needs to be supplied from the end of the arbor inlay. Coolant cannot be supplied from the set bolt.

TLA15-M

Square shoulder mill for roughing, with screw clamp system

GAMP = +12° ~ +13.5°, GAMF = -6° ~ -3.5°

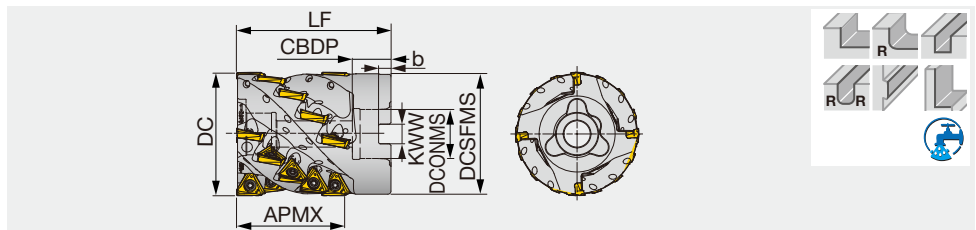

Designation	APMX	DC	ZEPF	CICT	DCSFMS	DCONMS	CBDP	LF	b	KWW	WT(kg)	Air hole	Insert
TLA15R080L070M31.7-04M	70	80	4	20	78	31.75	32	100	8	12.7	2.29	with	TO*T15...
TLA15R080L070M32.0E04M	70	80	4	20	78	32	25	100	8	14.4	2.38	with	TO*T15...
TLA15R100L083M38.1-05M	83	100	5	30	98	38.1	38	110	10	15.9	4.24	with	TO*T15...
TLA15R100L083M40.0E05M	83	100	5	30	98	40	32	110	9	16.4	4.26	with	TO*T15...

Note: Coolant needs to be supplied from the end of the arbor inlay. Coolant cannot be supplied from the set bolt.

TLA15-S

Subunit for TLA15-M, square shoulder mill for roughing, with screw clamp system, for triangular inserts

GAMP = +12° ~ +13.5°, GAMF = -6° ~ -3.5°

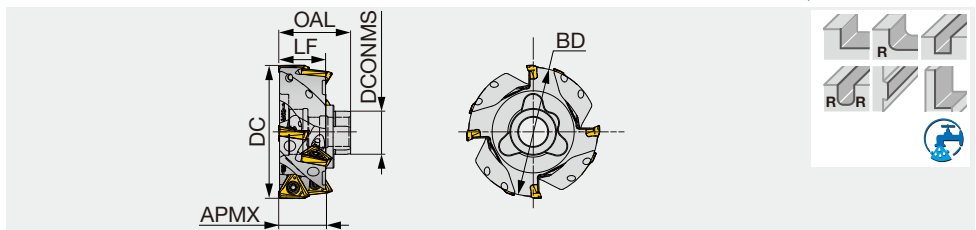

Designation	APMX	DC	ZEPF	CICT	BD	DCONMS	OAL	LF	WT(kg)	Air hole	Insert
TLA15R080L028-04S	28	80	4	8	77.6	27	43	28.2	0.65	with	TO*T15...
TLA15R100L028-05S	28	100	5	10	97.2	33	46	28	1.05	with	TO*T15...

Note: Coolant needs to be supplied from the end of the arbor inlay. Coolant cannot be supplied from the set bolt.

SPARE PARTS

Designation	Clamping screw	Grip	Lubricant	Torx bit	Center bolt 1	Center bolt 2	Wrench
TLA10R050L054M22.0E04	SR14-562	-	M-1000	-	CAP-CM10X1.5X55-H	-	T-10D
TLA10R063L...	SR14-562	-	M-1000	-	-	CAP-CM12X1.75X50	T-10D
TLA15R080L*M...	TS45120I	H-TB2W	M-1000	BT20S	-	CM16X75	-
TLA15R100*M...	TS45120I	H-TB2W	M-1000	BT20S	-	CM20X80	-
TLA15R**L028-**S	TS45120I	H-TB2W	M-1000	BT20S	-	-	-

Recommended clamping torque: SR14-562 = 3.5 N·m, TS45120I = 5 N·m

CENTER BOLT

(Optional parts)

No. of subunits	1	2
TLA15R080L028-04S	CM16x120	CM16x140
TLA15R100L028-05S	CM20x120	CM20x150

Reference pages: Inserts → **H136**, Standard cutting conditions → **H137 - H138**



TUNG-TRI

TLA15-BT

Square shoulder mill for roughing, with BT tapered shank

GAMP = +12°~ +13.5°, GAMF = -6°~ -3.5°

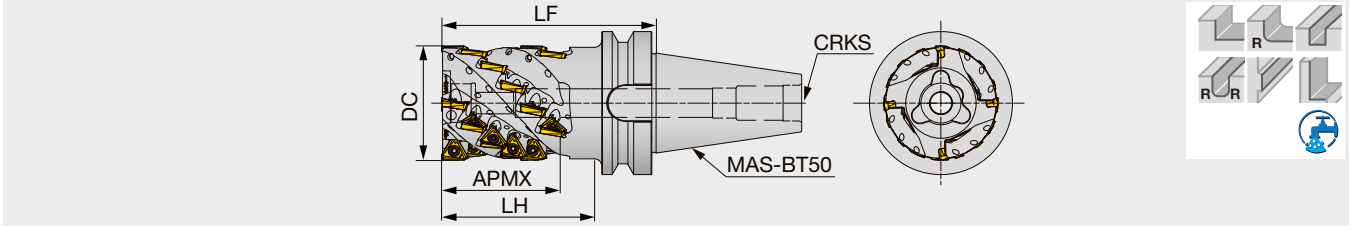

Designation	APMX	DC	ZEFP	CICT	LF	LH	WT(kg)	Air hole	CRKS	Insert
TLA15R080L083BT50-04M	83	80	4	24	150	107	6.29	with	M24	TO*T15...
TLA15R100L097BT50-05M	97	100	5	35	165	126.5	8.92	with	M24	TO*T15...

C-TLA

Square shoulder mill for roughing

GAMP = +13.5°~ +17°, GAMF = -5.5°~ -5°

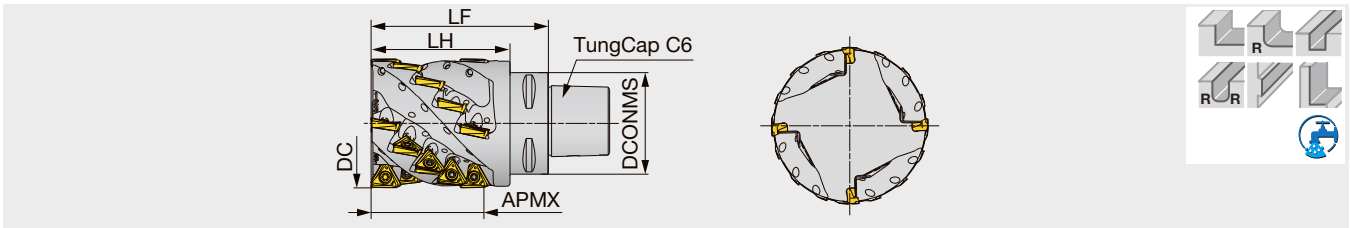

Designation	APMX	DC	ZEFP	CICT	LF	LH	DCONMS	WT(kg)	Air hole	Insert
C6TLA15M063R03L100	55	63	3	12	100	78	63	2.13	with	TO*T15...
C6TLA15M080R04L110	70	80	4	20	110	86.2	63	3.17	with	TO*T15...

Applicable for 7 MPa coolant

Approach angle



SPARE PARTS

Designation	Clamping screw	Grip	Lubricant	Torx bit	Shell locking bolt
TLA15R080L083BT50-04M	TS45120I	H-TB2W	M-1000	BT20S	CAP-CM16x2.0x55
TLA15R100L097BT50-05M	TS45120I	H-TB2W	M-1000	BT20S	CAP-CM20x2.5x50
C6TLA15M0**R0*L1**	TS45120I	H-TB2W	-	BT20S	-

Recommended clamping torque: 5 N·m

CENTER BOLT

(Optional parts)

No. of subunits	1	2
TLA15R080L083BT50-04M	CAP-CM16x2.0x55	CM16x90
TLA15R100L097BT50-05M	CAP-CM20x2.5x50	CM20x80

Caution for using NMJ chipbreaker

! Insert with NMJ chipbreaker has a number marked on each corner.
DO NOT place the corners with the same number in adjacent flute as the cutter may be damaged.

For example, if you place the corner #1 in one flute, be sure to use #2 or #3 (and avoid #1) in the next one.

Item: TOMT150608PDER-NMJ

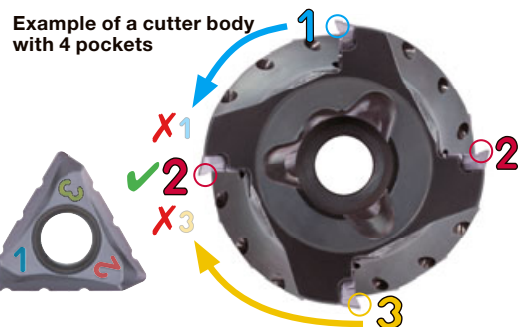

Reference pages: Inserts → **H136**, Standard cutting conditions → **H137 - H138**

Directions for setting NMJ inserts on roughing type bodies

- 1 Attach the insert on the cutter body so that the number on the working cutting edge matches the first number marked on the cutter body. (See the image on the right.)
- 2 Attach the remaining inserts on the same flute with the same number marked on the working cutting edge.
- 3 Repeat steps 1 and 2 for the other flutes.
- 4 Make sure the number on the working cutting edge is different from the number used on the adjacent flutes.

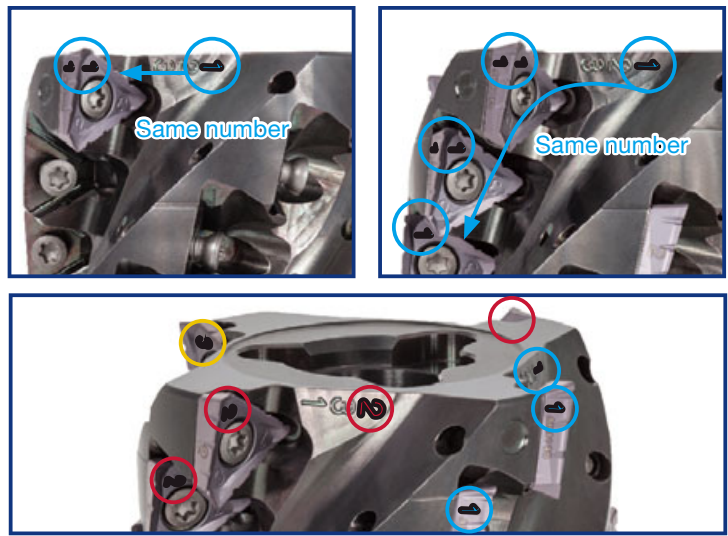

Directions for changing corners for inserts on roughing type bodies

- 1
 - a First time to change the corner rotate the insert clock-wise to match the number on the working cutting edge with the second number marked on the cutter body. (See the image on the right.)
Ex: 1 → 2
2 → 3
3 → 1
 - b Second time to change the corner rotate the insert clock-wise to match the number on the working cutting edge with the last number marked on the cutter body. (See the image on the right.)
Ex: 2 → 3
3 → 1
1 → 2
- 2 Repeat step 1 for all inserts.
- 3 Make sure the number on the working cutting edge is different from the number used on the adjacent flutes.

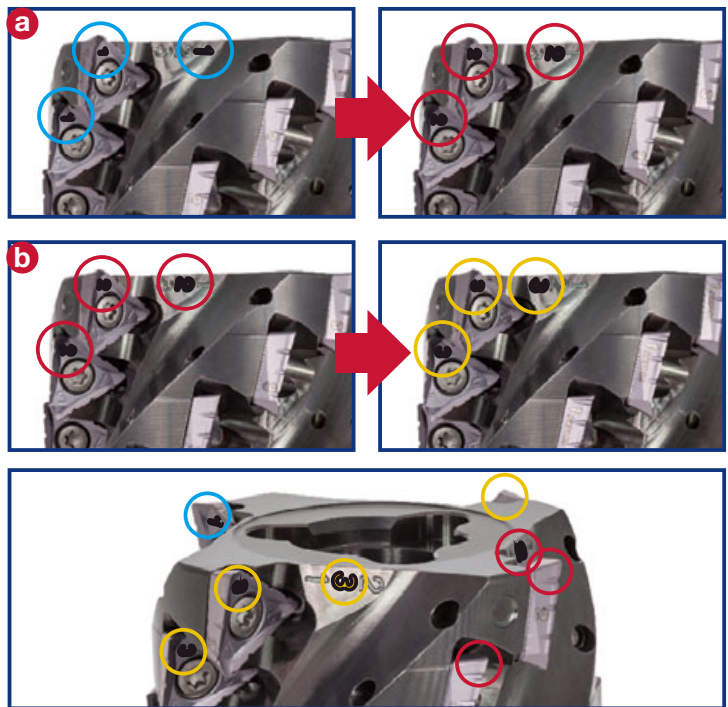

How to set a sub-unit

When setting a sub-unit on the main unit or another sub-unit, be sure to match the markings on the units. Sub-unit has a projection for error-proofing to avoid setting error.

Projection for error-proofing (Poka-yoke)

Marking

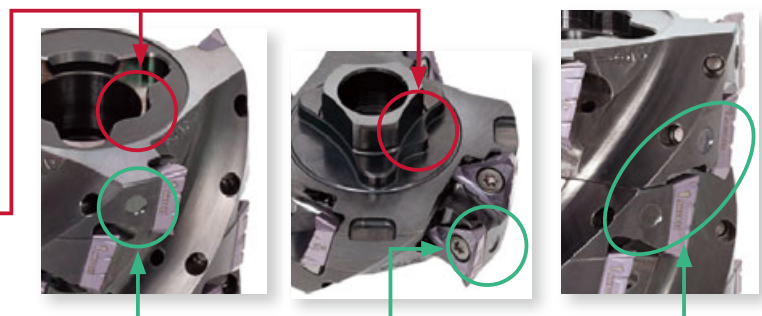

-  High Feed Milling
-  Face Milling
-  Shoulder Milling
-  Slot Milling
-  Profile Milling
-  Chamfering, Counterbore
-  Finish Face Milling
-  Approach angle
7°-25°
-  Approach angle
41°-45°
-  Approach angle
60°-70°
-  Approach angle
85°-88°
-  Approach angle
90°
-  Others

INSERTS

TOMT-MM

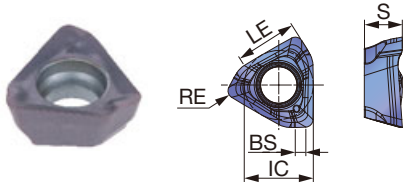

TOMT-MJ

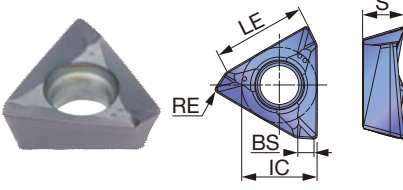

TOET-MJ

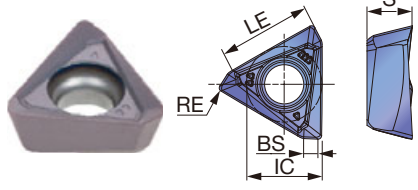

TOGT-AJ

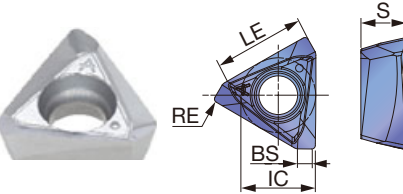

TOMT-NMJ

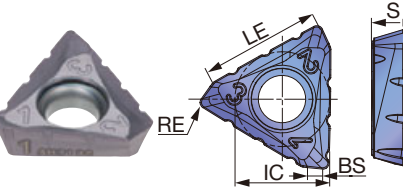

P Steel	☆	★	★		☆					
M Stainless		★	★		☆					
K Cast iron	★			★						
N Non-ferrous							★			
S Superalloys	★	☆	★	★						
H Hard materials				★						

★ : First choice
☆ : Second choice

Designation	RE	APMX	Coated					Un-coated	LE	IC	S	BS
			AH120	AH3135	AH3225	AH8015	T1215	T3225				
TOMT040204PXER-MM	0.4	3.5	●	●	●				3.6	4	2.2	0.6
TOMT040208PXER-MM	0.8	3.5	●	●	●				3.6	4	2.2	0.2
TOMT060302PDER-MJ	0.2	6	●	●	●				6.2	5.6	3.2	1.4
TOMT060304PDER-MJ	0.4	6	●	●	●			●	6.2	5.6	3.2	1.2
TOMT060308PDER-MJ	0.8	6	●	●	●			●	6.2	5.6	3.2	0.8
TOGT060304PDFR-AJ	0.4	6						●	6.2	5.6	3.3	1.2
TOGT060308PDFR-AJ	0.8	6						●	6.2	5.6	3.3	0.8
TOET060302PDER-MJ	0.2	6		●	●				6.2	5.6	3.3	1.3
TOET060304PDER-MJ	0.4	6		●	●				6.2	5.6	3.3	1.1
TOMT100404PDER-MJ	0.4	10	●	●	●			●	10.5	8.6	4.7	1.5
TOMT100408PDER-MJ	0.8	10	●	●	●			●	10.5	8.6	4.7	1.1
TOMT100416PDER-MJ	1.6	10	●	●	●				10.5	8.6	4.7	0.2
TOGT100404PDFR-AJ	0.4	10						●	10.5	8.6	5.2	1.5
TOGT100408PDFR-AJ	0.8	10						●	10.5	8.6	5.1	1.1
TOET100404PDER-MJ	0.4	10		●	●				10.5	8.6	5.1	1.5
TOET100408PDER-MJ	0.8	10		●	●				10.5	8.6	5.1	1.1
TOMT150604PDER-MJ	0.4	15	●	●	●			●	15.7	12.7	6	2.2
TOMT150608PDER-MJ	0.8	15	●	●	●			●	15.7	12.7	6	1.9
TOMT150616PDER-MJ	1.6	15	●	●	●				15.7	12.7	6	1.1
TOMT150620PDER-MJ	2	15	●	●	●				15.7	12.7	6	0.7
TOMT150608PDER-NMJ	0.8	15	●	●	●			●	15.7	12.7	6	1.9
TOGT150604PDFR-AJ	0.4	15						●	15.7	12.5	5.6	2.1
TOGT150608PDFR-AJ	0.8	15						●	15.7	12.5	5.5	1.8
TOET150604PDER-MJ	0.4	15		●	●				15.7	12.5	5.6	2.2
TOET150608PDER-MJ	0.8	15		●	●				15.7	12.5	5.6	1.9

● : Line up

STANDARD CUTTING CONDITIONS

EPA04

ISO	Workpiece materials	Hardness	Grades	Cutting speed Vc (m/min)	Feed per tooth fz (mm/t)
P	Low carbon steel SS400, S15C, etc. E275A, C15E4, etc.	- 200 HB	AH3225	100 - 250	0.05 - 0.12
	Carbon steel and alloy steel S55C, SCM440, etc. C55, 42CrMo4, etc.	- 300 HB	AH3225	100 - 230	0.05 - 0.12
	Prehardened steel NAK80, PX5, etc.	30 - 40 HRC	AH3225	100 - 180	0.05 - 0.1
M	Stainless steel SUS304, etc. X5CrNi18-9, etc.	- 200 HB	AH3225	90 - 200	0.05 - 0.1
K	Grey cast iron FC250, etc. 250, etc., GG25, etc.	150 - 250 HB	AH120	100 - 300	0.05 - 0.12
	Ductile cast iron FCD450, etc. 450-10S, etc., GGG45, etc.	150 - 250 HB	AH120	100 - 200	0.05 - 0.12
S	Titanium alloys Ti-6Al-4V, etc.	- 40 HRC	AH3225	20 - 60	0.04 - 0.07
	Heat-resistant alloys Inconel 718, etc.	- 40 HRC	AH8015	20 - 40	0.04 - 0.07
H	Hardened steel	SKD61, etc. X40CrMoV5-1, etc.	AH8015	50 - 150	0.04 - 0.07
		SKD11, etc. X153CrMoV12, etc.	AH8015	40 - 70	0.04 - 0.07

· Remove excessive chip accumulation with an air blast.
· For an operation when the depth of cut varies (ex.casting skin) or machining of workpiece materials with interrupted surface, the feed per tooth (fz) should be set to the lower recommended value shown in the above table.

· Cutting conditions may be limited depending on machine power, workpiece rigidity, and spindle output. When the cutting width, depth, or overhang length is large, set Vc and fz to the lower recommended values and check the machine power and vibration.

T/E/HPA06, T/E/HPA10, T/EPA15

ISO	Workpiece materials	Hardness	Priority	Chip-breakers	Grades	T/E/HPA06		T/E/HPA10		T/EPA15	
						Cutting speed Vc (m/min)	Feed per tooth fz (mm/t)	Cutting speed Vc (m/min)	Feed per tooth fz (mm/t)	Cutting speed Vc (m/min)	Feed per tooth fz (mm/t)
P	Low carbon steel SS400, S15C, etc. E275A, C15E4, etc.	- 200 HB	First choice	MJ/NMJ	AH3225	100 - 220	0.05 - 0.15	100 - 250	0.08 - 0.2	100 - 300	0.06 - 0.22 0.06 - 0.15
			Wear resistance	MJ/NMJ	T3225	100 - 250	0.08 - 0.1	100 - 300	0.08 - 0.12	100 - 300	0.08 - 0.15 0.08 - 0.15
	Carbon steel and alloy steel S55C, SCM440, etc. C55, 42CrMo4, etc.	- 300 HB	First choice	MJ/NMJ	AH3225	100 - 170	0.05 - 0.12	100 - 250	0.06 - 0.22	100 - 250	0.06 - 0.22 0.06 - 0.15
			Wear resistance	MJ/NMJ	T3225	100 - 250	0.05 - 0.1	100 - 300	0.05 - 0.12	100 - 300	0.05 - 0.15 0.05 - 0.15
	Prehardened steel and tool steel NAK80, PX5, SKD61, etc. X40CrMoV5-1, etc.	30 - 40 HRC	First choice	MJ/NMJ	AH3225	100 - 120	0.05 - 0.12	100 - 200	0.06 - 0.22	100 - 200	0.06 - 0.22 0.06 - 0.15
			Wear resistance	MJ/NMJ	T3225	100 - 250	0.05 - 0.1	100 - 300	0.05 - 0.12	100 - 300	0.05 - 0.15 0.05 - 0.15
M	Stainless steel SUS304, etc. X5CrNi18-9, etc.	- 200 HB	First choice	MJ/NMJ	AH3135	80 - 150	0.05 - 0.15	80 - 200	0.08 - 0.2	90 - 200	0.08 - 0.2 0.08 - 0.15
			Wear resistance	MJ/NMJ	T3225	90 - 200	0.05 - 0.1	90 - 250	0.05 - 0.12	90 - 250	0.05 - 0.15 0.05 - 0.15
K	Grey cast iron FC250, etc. 250, etc., GG25, etc.	150 - 250 HB	First choice	MJ/NMJ	AH120	100 - 200	0.05 - 0.15	100 - 250	0.05 - 0.15	140 - 250	0.08 - 0.25 0.08 - 0.15
			Wear resistance	MJ	T1215	150 - 250	0.05 - 0.12	150 - 300	0.08 - 0.2	200 - 300	0.08 - 0.18 -
	Ductile cast iron FCD450, etc. 450-10S, etc., GGG45, etc.	150 - 250 HB	First choice	MJ/NMJ	AH120	80 - 150	0.05 - 0.15	80 - 200	0.08 - 0.2	110 - 200	0.08 - 0.25 0.08 - 0.15
			Wear resistance	MJ	T1215	100 - 200	0.05 - 0.12	130 - 250	0.05 - 0.15	150 - 250	0.08 - 0.18 -
N	Aluminium Si < 13%	-	First choice	AJ	KS05F	300 - 900	0.08 - 0.22	300 - 1000	0.08 - 0.22	300 - 1000	0.08 - 0.22 -
	Aluminium Si ≥ 13%	-	First choice	AJ	KS05F	100 - 200	0.08 - 0.22	100 - 200	0.08 - 0.22	100 - 200	0.08 - 0.22 -
S	Titanium alloys Ti-6Al-4V, etc.	- 40 HRC	First choice	MJ/NMJ	AH3135	20 - 50	0.05 - 0.1	20 - 60	0.05 - 0.1	20 - 60	0.08 - 0.15 0.08 - 0.15
	Heat-resistant alloys Inconel 718, etc.	- 40 HRC	First choice	MJ/NMJ	AH120	20 - 35	0.03 - 0.08	20 - 40	0.05 - 0.13	20 - 40	0.07 - 0.15 0.07 - 0.15

· When you use the NMJ chipbreaker, please set up the feed less than 0.15 mm/t.
· Remove excessive chip accumulation with an air blast.
· For an operation when the depth of cut varies (ex.casting skin) or machining of workpiece materials with interrupted surface, the feed per tooth (fz) should be set to the lower recommended value shown in the above table.

· Cutting conditions may be limited depending on machine power, workpiece rigidity, and spindle output. When the cutting width, depth, or overhang length is large, set Vc and fz to the lower recommended values and check the machine power and vibration.

Grade
Insert
Ext. Toolholder
Int. Toolholder
Threading
Grooving
Miniature tool
Milling cutter
Endmill
Drilling tool
Tooling System
User's Guide
Index



STANDARD CUTTING CONDITIONS

TLA (Roughing type)

ISO	Workpiece materials	Hardness	Priority	Chip-breakers	Grades	TLA10		TLA15			
						Cutting speed Vc (m/min)	Feed per tooth fz (mm/t)	Cutting speed Vc (m/min)	Feed per tooth fz (mm/t)		
									MJ/AJ	NMJ	
P	Low carbon steel SS400, S15C, etc. E275A, C15E4, etc.	- 200 HB	First choice	MJ/NMJ	AH3225	100 - 250	0.08 - 0.2	100 - 300	0.06 - 0.22	0.06 - 0.15	
			Wear resistance	MJ/NMJ	T3225	100 - 300	0.08 - 0.12	100 - 300	0.08 - 0.15	0.08 - 0.15	
	Carbon steel and alloy steel S55C, SCM440, etc. C55, 42CrMo4, etc.	- 300 HB	First choice	MJ/NMJ	AH3225	100 - 250	0.06 - 0.22	100 - 250	0.06 - 0.22	0.06 - 0.15	
			Wear resistance	MJ/NMJ	T3225	100 - 300	0.05 - 0.12	100 - 300	0.05 - 0.15	0.05 - 0.15	
	Prehardened steel and tool steel NAK80, PX5, SKD61, etc. X40CrMoV5-1, etc.	30 - 40 HRC	First choice	MJ/NMJ	AH3225	100 - 200	0.06 - 0.22	100 - 200	0.06 - 0.22	0.06 - 0.15	
			Wear resistance	MJ/NMJ	T3225	100 - 300	0.05 - 0.12	100 - 300	0.05 - 0.15	0.05 - 0.15	
	M	Stainless steel SUS304, etc. X5CrNi18-9, etc.	- 200 HB	First choice	MJ/NMJ	AH3135	80 - 200	0.08 - 0.2	90 - 200	0.08 - 0.2	0.08 - 0.15
				Wear resistance	MJ/NMJ	T3225	90 - 250	0.05 - 0.12	90 - 250	0.05 - 0.15	0.05 - 0.15
K	Grey cast iron FC250, etc. 250, etc. GG25, etc.	150 - 250 HB	First choice	MJ/NMJ	AH120	100 - 250	0.05 - 0.15	140 - 250	0.08 - 0.25	0.08 - 0.15	
			Wear resistance	MJ	T1215	150 - 300	0.08 - 0.2	200 - 300	0.08 - 0.18	-	
	Ductile cast iron FCD450, etc. 450-10S, etc. GGG45, etc.	150 - 250 HB	First choice	MJ/NMJ	AH120	80 - 200	0.08 - 0.2	110 - 200	0.08 - 0.25	0.08 - 0.15	
			Wear resistance	MJ	T1215	130 - 250	0.05 - 0.15	150 - 250	0.08 - 0.18	-	
N	Aluminium Si < 13%	-	First choice	AJ	KS05F	300 - 1000	0.08 - 0.22	300 - 1000	0.08 - 0.22	-	
	Aluminium Si ≥ 13%	-	First choice	AJ	KS05F	100 - 200	0.08 - 0.22	100 - 200	0.08 - 0.22	-	
S	Titanium alloys Ti-6Al-4V, etc.	- 40 HRC	First choice	MJ/NMJ	AH3135	20 - 60	0.05 - 0.1	20 - 60	0.08 - 0.15	0.08 - 0.15	
	Heat-resistant alloys Inconel 718, etc.	- 40 HRC	First choice	MJ/NMJ	AH120	20 - 40	0.05 - 0.13	20 - 40	0.07 - 0.15	0.07 - 0.15	

• When using NMJ chipbreaker, please set up the feed not to exceed 0.15 mm/t.

7°-25°

41°-45°

60°-70°

85°-88°

90°

Others

APPLICATION RANGE

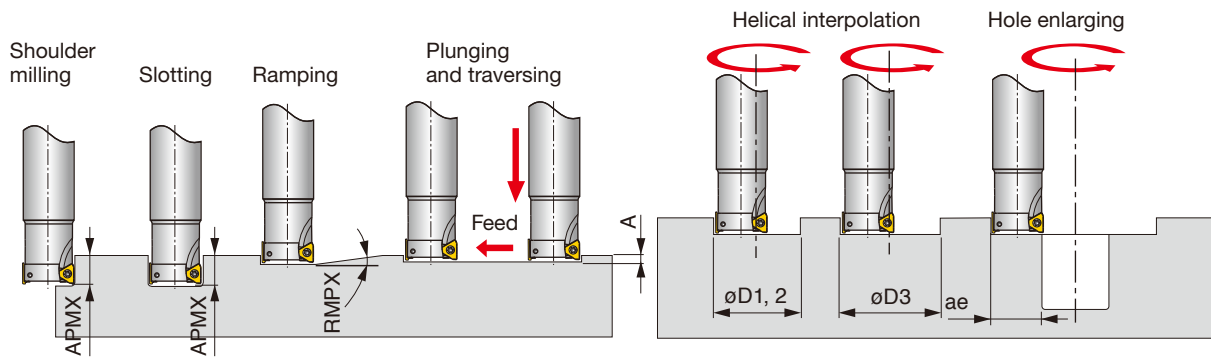

Designation	DC	Max. depth of cut		Max. plunging depth	Min. machining diameter	Max. machining diameter		Max. cutting width in enlarging
		APMX	RMPX			øD1	øD2	
EPA04R008...	8	3.5	0.3°	0.02	12.8	15.6	13.6	7.5
EPA04R010...	10	3.5	0.2°	0.02	16.8	19.6	17.6	9.5
EPA04R012...	12	3.5	0.15°	0.02	20.8	23.6	21.6	11.5
EPA04R016...	16	3.5	0.1°	0.02	28.8	31.6	29.6	15.5
EPA04R020...	20	3.5	0.1°	0.02	36.8	39.6	37.6	19.5
EPA04R025...	25	3.5	0.1°	0.02	46.8	49.6	47.6	24.5
EPA06R012...	12	6	5°	0.6	18	23.6	21	11.5
E/HPA06R016...	16	6	4.3°	0.6	25	31.6	29	15.5
EPA06R018...	18	6	3.5°	0.6	29.5	35.6	33	17.5
E/HPA06R020...	20	6	2.8°	0.6	33.5	39.6	37	19.5
EPA06R022...	22	6	2.5°	0.6	37.5	43.6	41	21.5
E/HPA06R025...	25	6	2°	0.6	43.5	49.6	47	24.5
E/HPA10R025...	25	10	2°	0.6	42.1	49.6	47	24.5
EPA06R028...	28	6	1.8°	0.6	49.5	55.6	53	27.5
EPA10R028...	28	10	2°	0.6	48.1	55.6	53	27.5
T/HPA06R032...	32	6	1.5°	0.6	57.5	63.6	61	31.5
E/HPA10R032...	32	10	2°	0.6	56.1	63.6	61	31.5
EPA10R035...	35	10	1.7°	0.6	62.1	69.6	67	34.5
TPA06R040...	40	6	1°	0.6	73.5	79.6	77	39.5
T/EPA10R040...	40	10	1.4°	0.6	72.1	79.6	77	39.5
EPA15R040...	40	15	2.3°	0.8	68.5	79.2	75.5	39
TPA06R050...	50	6	0.7°	0.6	94	99.6	97	49.5
TPA10R050...	50	10	0.9°	0.6	92.1	99.6	97	49.5
T/EPA15R050...	50	15	1.7°	0.8	88.5	99.2	95.5	49
TPA10R063...	63	10	0.8°	0.6	118.1	125.6	123	62.5
TPA15R063...	63	15	1.4°	0.8	114.5	125.2	121.5	62
TPA10R080...	80	10	0.6°	0.6	152.1	159.6	157	79.5
TPA15R080...	80	15	1°	0.8	148.5	159.2	155.5	79
TPA10R100...	100	10	0.5°	0.6	192.1	199.6	197	99.5
TPA15R100...	100	15	0.8°	0.8	188.5	199.2	195.5	99
TPA15R125...	125	15	0.6°	0.8	238.5	249.2	245.5	124
TPA15R160...	160	15	0.5°	0.8	308.5	319.2	315.5	159

* Flat bottom hole

Note: Corner RE for dimensions of øD1, øD2 and øD3: RE = 0.4 for EPA04, T/E/HPA06, T/E/HPA10 and RE = 0.8 for T/EPA15.

Grade
Insert
Ext. Toolholder
Int. Toolholder
Threading
Grooving
Miniature tool
Milling cutter
Endmill
Drilling tool
Tooling System
User's Guide
Index

A
B
C
D
E
F
G
H
I
J
K
L
M



TUNGREC

EPO07/11/18



High precision square shoulder endmill, shank type, with screw clamp system

EPO07: GAMP = +7°, GAMF = +13° ~ +18°
 EPO11: GAMP = +8.7° ~ +18°, GAMF = -5.3° ~ -19.4°
 EPO18: GAMP = +14° ~ +17°, GAMF = +22° ~ +31°

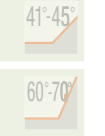
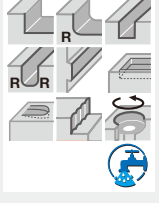
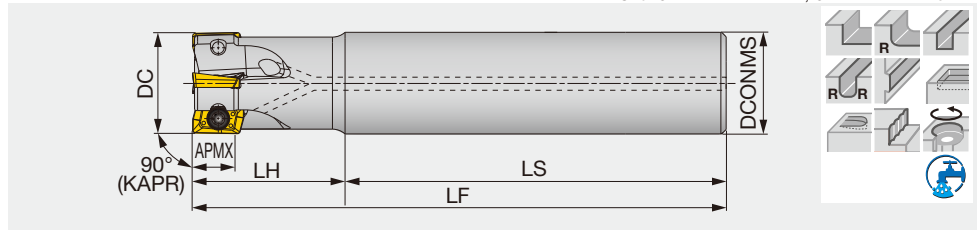

Designation	APMX	DC	CICT	DCONMS	LS	LH	LF	WT(kg)	Air hole	Insert
EPO07R012M12.0-02	7	12	2	12	50	18	68	0.1	With	AO*T0702...
EPO07R012M12.0-02L	7	12	2	12	95	30	125	0.1	With	AO*T0702...
EPO11R012M16.0-01	10.6	12	1	16	60	25	85	0.11	With	AS*T11T3...
EPO11R012M16.0-01L	10.6	12	1	16	95	30	125	0.16	With	AS*T11T3...
EPO07R016M12.0-02	7	16	2	12	50	20	70	0.1	With	AO*T0702...
EPO07R016M16.0-02L	7	16	2	16	105	40	145	0.2	With	AO*T0702...
EPO07R016M16.0-04	7	16	4	16	60	24	84	0.1	With	AO*T0702...
EPO11R016M16.0-02	10.6	16	2	16	60	25	85	0.12	With	AS*T11T3...
EPO11R016M16.0-02L	10.6	16	2	16	105	40	145	0.2	With	AS*T11T3...
EPO07R018M16.0-02L	7	18	2	16	105	40	145	0.2	With	AO*T0702...
EPO07R018M16.0-04	7	18	4	16	60	24	84	0.1	With	AO*T0702...
EPO11R018M16.0-02	10.6	18	2	16	60	25	85	0.12	With	AS*T11T3...
EPO11R018M16.0-02L	10.6	18	2	16	105	40	145	0.21	With	AS*T11T3...
EPO07R020M16.0-03	7	20	3	16	60	30	90	0.1	With	AO*T0702...
EPO07R020M20.0-03L	7	20	3	20	135	50	185	0.4	With	AO*T0702...
EPO07R020M20.0-05	7	20	5	20	70	30	100	0.2	With	AO*T0702...
EPO11R020M20.0-02	10.6	20	2	20	70	30	100	0.22	With	AS*T11T3...
EPO11R020M20.0-02L	10.6	20	2	20	135	50	185	0.41	With	AS*T11T3...
EPO11R020M20.0-03	10.6	20	3	20	70	30	100	0.21	With	AS*T11T3...
EPO07R022M20.0-05	7	22	5	20	70	30	100	0.2	With	AO*T0702...
EPO11R022M20.0-02	10.6	22	2	20	70	30	100	0.22	With	AS*T11T3...
EPO11R022M20.0-02L	10.6	22	2	20	155	30	185	0.42	With	AS*T11T3...
EPO11R022M20.0-03	10.6	22	3	20	70	30	100	0.22	With	AS*T11T3...
EPO07R025M20.0-03	7	25	3	20	60	35	95	0.3	With	AO*T0702...
EPO07R025M25.0-03L	7	25	3	25	150	70	220	0.7	With	AO*T0702...
EPO07R025M25.0-07	7	25	7	25	80	35	115	0.4	With	AO*T0702...
EPO11R025M25.0-02L	10.6	25	2	25	150	70	220	0.76	With	AS*T11T3...
EPO11R025M25.0-03	10.6	25	3	25	80	35	115	0.39	With	AS*T11T3...
EPO11R025M25.0-04	10.6	25	4	25	80	35	115	0.38	With	AS*T11T3...
EPO18R025M25.0-02	16.7	25	2	25	80	35	115	0.4	With	AO*T1805...
EPO18R025M25.0-02L	16.7	25	2	25	150	70	220	0.8	With	AO*T1805...
EPO07R028M25.0-03L	7	28	3	25	150	70	220	0.7	With	AO*T0702...
EPO07R028M25.0-07	7	28	7	25	80	35	115	0.4	With	AO*T0702...
EPO11R028M25.0-02L	10.6	28	2	25	185	35	220	0.8	With	AS*T11T3...
EPO11R028M25.0-03	10.6	28	3	25	80	35	115	0.4	With	AS*T11T3...
EPO11R028M25.0-04	10.6	28	4	25	80	35	115	0.39	With	AS*T11T3...
EPO18R028M25.0-02	16.7	28	2	25	80	35	115	0.4	With	AO*T1805...
EPO18R028M25.0-02L	16.7	28	2	25	150	70	220	0.8	With	AO*T1805...
EPO11R030M25.0-02L	10.6	30	2	25	180	40	220	0.8	With	AS*T11T3...
EPO11R030M25.0-03	10.6	30	3	25	80	40	120	0.43	With	AS*T11T3...
EPO11R030M25.0-04	10.6	30	4	25	80	40	120	0.42	With	AS*T11T3...
EPO18R030M32.0-02	16.7	30	2	32	80	40	120	0.6	With	AO*T1805...
EPO18R030M32.0-02L	16.7	30	2	32	175	80	255	1.4	With	AO*T1805...
EPO18R030M32.0-03	16.7	30	3	32	80	40	120	0.6	With	AO*T1805...
EPO11R032M32.0-02L	10.6	32	2	32	175	80	255	1.48	With	AS*T11T3...
EPO11R032M32.0-03	10.6	32	3	32	80	40	120	0.68	With	AS*T11T3...
EPO11R032M32.0-05	10.6	32	5	32	80	40	120	0.67	With	AS*T11T3...
EPO18R032M32.0-02	16.7	32	2	32	80	40	120	0.7	With	AO*T1805...
EPO18R032M32.0-02L	16.7	32	2	32	175	80	255	1.5	With	AO*T1805...
EPO18R032M32.0-03	16.7	32	3	32	80	40	120	0.6	With	AO*T1805...
EPO11R035M32.0-02L	10.6	35	2	32	215	40	255	1.49	With	AS*T11T3...
EPO11R035M32.0-03	10.6	35	3	32	80	40	120	0.69	With	AS*T11T3...
EPO11R035M32.0-05	10.6	35	5	32	80	40	120	0.67	With	AS*T11T3...
EPO18R035M32.0-02	16.7	35	2	32	80	40	120	0.7	With	AO*T1805...
EPO18R035M32.0-02L	16.7	35	2	32	175	80	255	1.5	With	AO*T1805...
EPO18R035M32.0-03	16.7	35	3	32	80	40	120	0.7	With	AO*T1805...
EPO11R040M32.0-02L	10.6	40	2	32	205	50	255	1.53	With	AS*T11T3...

Designation	APMX	DC	CICT	DCONMS	LS	LH	LF	WT(kg)	Air hole	Insert
EPO11R040M32.0-04	10.6	40	4	32	80	40	120	0.72	With	AS*T11T3...
EPO11R040M32.0-06	10.6	40	6	32	80	40	120	0.71	With	AS*T11T3...
EPO18R040M32.0-02L	16.7	40	2	32	205	50	255	1.6	With	AO*T1805...
EPO18R040M32.0-03	16.7	40	3	32	80	40	120	0.7	With	AO*T1805...
EPO18R040M32.0-04	16.7	40	4	32	80	40	120	0.7	With	AO*T1805...
EPO18R040M42.0-02L	16.7	40	2	42	210	100	310	3	With	AO*T1805...
EPO11R050M32.0-05	10.6	50	5	32	80	40	120	0.83	With	AS*T11T3...
EPO11R050M32.0-07	10.6	50	7	32	80	40	120	0.82	With	AS*T11T3...
EPO11R050M42.0-03L	10.6	50	3	42	310	50	360	3.78	With	AS*T11T3...
EPO18R050M32.0-03	16.7	50	3	32	80	40	120	0.8	With	AO*T1805...
EPO18R050M32.0-05	16.7	50	5	32	80	40	120	0.8	With	AO*T1805...
EPO18R050M42.0-03L	16.7	50	3	42	310	50	360	3.8	With	AO*T1805...
EPO18R063M32.0-04	16.7	63	4	32	80	45	125	1	With	AO*T1805...
EPO18R063M32.0-06	16.7	63	6	32	80	45	125	1.1	With	AO*T1805...
EPO18R063M42.0-03L	16.7	63	3	42	310	50	360	4	With	AO*T1805...

EPO07:

- The APMX is the diameter when using MJ chipbreaker.
- The DC is the diameter when using MJ or AJ chipbreaker. With HJ chipbreaker, the tool diameter is (DC + 0.6 mm).
- The LF and L are the lengths when using MJ chipbreaker. With AJ chipbreaker, the length is (LF, L + 0.1 mm). With HJ chipbreaker, the length is (LF, L + 0.5 mm).

EPO11:

- The APMX is the diameter when using MJ, MS and AJ chipbreaker.

EPO18:

The DC is the diameter when using MJ chipbreaker. With AJ chipbreaker, the tool diameter is (DC above + 0.2 mm).

SPARE PARTS



Designation	Clamping screw	Lubricant	Wrench
EPO07R012...	SR 10503833-S	-	T-7DB
EPO07R016 - 028...	CSTB-2.5L046	-	T-7DB
EPO11R012 - 022...	CSPB-2.5S	M-1000	IP-8D
EPO11R025 - 050...	CSPB-2.5	M-1000	IP-8D
EPO18R025 - 030...	CSTB-4L085	-	T-15DB
EPO18R032 - 050...	CSTB-4L093	-	T-15DB
EPO18R063M...	CSTB-4L120	-	T-15DB

Recommended clamping torque: SR 10503833-S, CSTB-2.5L046 = 0.9 N·m, CSPB-2.5, CSPB-2.5S = 1.3 N·m, CSTB-4L085, CSTB-4L093, CSTB-4L120 = 3.5 N·m

HPO07/11-M

High precision square shoulder endmill, modular type (TungFlex)

HPO07-M: GAMP = +7°, GAMF = +13° ~ +18°
HPO11-M: GAMP = +8.7° ~ +18°, GAMF = -5.3° ~ -19.4°

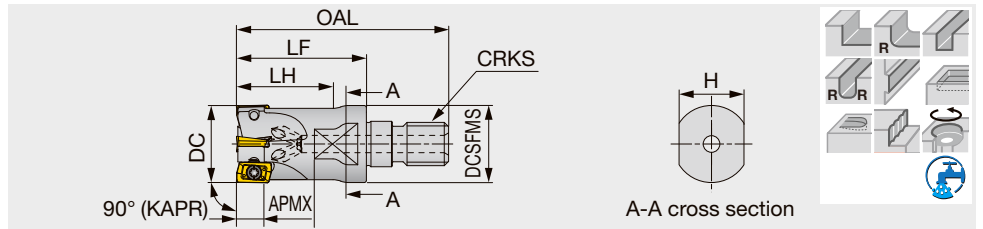

Designation	APMX	DC	CICT	OAL	LF	LH	H	DCSFMS	CRKS	WT(kg)	Air hole	Insert
HPO07R012MM06-02	7	12	2	39.5	25	-	7	9.8	M6	0.01	With	AO*T0702...
HPO07R012MM08-02	7	12	2	42	25	20	10	12.8	M8	0.02	With	AO*T0702...
HPO07R016MM08-04	7	16	4	42	25	-	10	12.8	M8	0.03	With	AO*T0702...
HPO07R016MM10-04	7	16	4	49	30	20	15	17.8	M10	0.05	With	AO*T0702...
HPO07R020MM10-05	7	20	5	49	30	-	15	17.8	M10	0.06	With	AO*T0702...
HPO11R020MM10-02	10.6	20	2	49	30	-	15	17.8	M10	0.06	With	AS*T11T3...
HPO07R025MM12-07	7	25	7	57	35	-	17	20.8	M12	0.1	With	AO*T0702...
HPO11R025MM12-03	10.6	25	3	57	35	-	17	20.8	M12	0.1	With	AS*T11T3...
HPO11R032MM16-03	10.6	32	3	63	40	-	22	28.8	M16	0.2	With	AS*T11T3...

SPARE PARTS



Designation	Clamping screw	Lubricant	Wrench
HPO07R012MM0*-02	SR 10503833-S	M-1000	T-7DB
HPO07R016 - 025...	CSTB-2.5L046	M-1000	T-7DB
HPO11R020MM10-02	CSPB-2.5S	M-1000	IP-8D
HPO11R025, 032...	CSPB-2.5	M-1000	IP-8D

Recommended clamping torque: SR 10503833-S, CSTB-2.5L046 = 0.9 N·m, CSPB-2.5, CSPB-2.5S = 1.3 N·m

Reference pages: Inserts → **H144 - H145**, TungFlex → **H036 - H037**

High precision square shoulder mill, with screw clamp system

TPO07: GAMP = +7°, GAMF = +13° ~ +18°
 TPO11: GAMP = +8.7° ~ +18°, GAMF = -5.3° ~ -19.4°
 TPO18: GAMP = +14° ~ +17°, GAMF = +22° ~ +31°

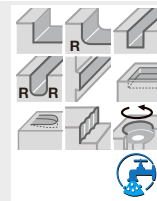
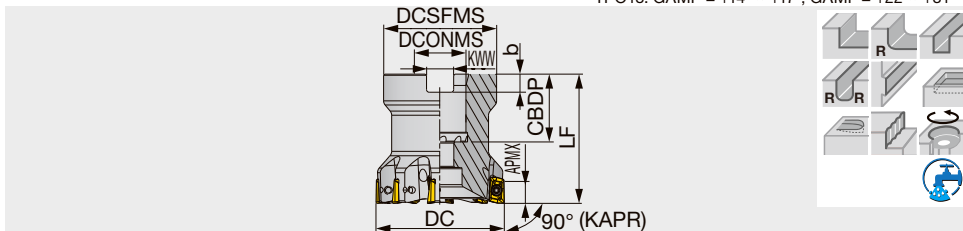

Designation	APMX	DC	CICT	DCSFMS	LF	DCONMS	CBDP	KWW	b	WT(kg)	Air hole	Insert
TPO07R032M16.0E08	7	32	8	30	40	16	21	8.4	5.6	0.1	With	AO*T0702...
TPO07R040M16.0E10	7	40	10	35	40	16	21	8.4	5.6	0.2	With	AO*T0702...
TPO07R050M22.0E12	7	50	12	41	40	22	22	10.4	6.3	0.3	With	AO*T0702...
TPO11R040M16.0E06	10.6	40	6	35	40	16	18	8.4	5.6	0.21	With	AS*T11T3...
TPO18R040M16.0-04	16.7	40	4	35	40	16	18	8.2	5.6	0.2	With	AO*T1805...
TPO18R040M16.0E04	16.7	40	4	35	40	16	18	8.4	5.6	0.2	With	AO*T1805...
TPO11R050M22.0E07	10.6	50	7	45	40	22	20	10.4	6.3	0.35	With	AS*T11T3...
TPO18R050M22.0-05	16.7	50	5	41	40	22	20	10	6	0.2	With	AO*T1805...
TPO18R050M22.0E05	16.7	50	5	41	40	22	20	10.4	6.3	0.3	With	AO*T1805...
TPO11R063M22.0E08	10.6	63	8	47	45	22	20	10.4	6.3	0.59	With	AS*T11T3...
TPO18R063M22.0-06	16.7	63	6	41	40	22	20	10	6	0.4	With	AO*T1805...
TPO18R063M22.0E06	16.7	63	6	41	40	22	20	10.4	6.3	0.5	With	AO*T1805...
TPO11R080M25.4-10	10.6	80	10	58	50	25.4	26	9.5	6	1.07	With	AS*T11T3...
TPO11R080M27.0E10	10.6	80	10	58	50	27	22	12.4	7	1.05	With	AS*T11T3...
TPO18R080M25.4-07	16.7	80	7	46	50	25.4	26	9.5	6	0.8	With	AO*T1805...
TPO18R080M27.0E07	16.7	80	7	50	50	27	22	12.4	7	1.0	With	AO*T1805...
TPO11R100M31.75-11	10.6	100	11	70	63	31.75	32	12.7	8	1.95	With	AS*T11T3...
TPO11R100M32.0E11	10.6	100	11	70	63	32	25	14.4	8	2.01	With	AS*T11T3...
TPO18R100M31.7-08	16.7	100	8	60	50	31.75	32	12.7	8	1.2	With	AO*T1805...
TPO18R100M32.0E08	16.7	100	8	60	50	32	28.5	14.4	8	1.4	With	AO*T1805...
TPO18R125M38.1-09	16.7	125	9	80	63	38.1	38	15.9	10	2.8	With	AO*T1805...
TPO18R125M40.0E09	16.7	125	9	71	63	40	32	16.4	9	2.8	With	AO*T1805...
TPO18R160M40.0E10	16.7	160	10	100	63	40	29	16.4	9	4.9	Without	AO*T1805...
TPO18R160M50.8-10	16.7	160	10	100	63	50.8	46	19	11	4.9	Without	AO*T1805...

TPO07:
 - The APMX is the diameter when using MJ chipbreaker.
 - The DC is the diameter when using MJ or AJ chipbreaker. With HJ chipbreaker, the tool diameter is (DC + 0.6 mm).
 - The LF and L are the lengths when using MJ chipbreaker. With AJ chipbreaker, the length is (LF, L + 0.1 mm). With HJ chipbreaker, the length is (LF, L + 0.5 mm).

TPO11:
 - The APMX is the diameter when using MJ, MS and AJ chipbreaker.

TPO18:
 The DC is the diameter when using MJ chipbreaker. With AJ chipbreaker, the tool diameter is (DC above + 0.2 mm).

SPARE PARTS	Clamping screw	Lubricant	Grip	Shell locking bolt 1	Shell locking bolt 2	Wrench	Torx bit
TPO07R032, 040...	CSTB-2.5L046	-	-	-	CM8X30H	T-7DB	-
TPO07R050M22.0E12	CSTB-2.5L046	-	-	-	CM10X30H	T-7DB	-
TPO11R040M16.0E06	CSPB-2.5	M-1000	-	-	CM8X30H	IP-8D	-
TPO11R050M, 063M...	CSPB-2.5	M-1000	-	-	CM10X30H	IP-8D	-
TPO11R080M25.4-10 TPO11R080M27.0E10	CSPB-2.5	M-1000	-	-	CM12X30H	IP-8D	-
TPO11R100M31.75-11	CSPB-2.5	M-1000	-	-	CM16X40H	IP-8D	-
TPO11R100M32.0E11	CSPB-2.5	M-1000	-	-	CM16X40H	IP-8D	-
TPO18R040M...	CSTB-4L093	-	H-TBS	-	FSHM8-30H	-	BT15M
TPO18R050M..., 063M...	CSTB-4L093	-	H-TBS	-	CM10X30H	-	BT15M
TPO18R080M...	CSTB-4L120	-	H-TBS	-	CM12X30H	-	BT15M
TPO18R100M...	CSTB-4L120	-	H-TBS	TMBA-M16H	-	-	BT15M
TPO18R125M...	CSTB-4L120	-	H-TBS	TMBA-M20H	-	-	BT15M
TPO18R160M...	CSTB-4L120	-	H-TBS	-	-	-	BT15M

Recommended clamping torque: CSTB-2.5L046 = 0.9 N·m, CSPB-2.5 = 1.3 N·m, CSTB-4L093, CSTB-4L120 = 3.5 N·m

Reference pages: Inserts → [H144 - H145](#)

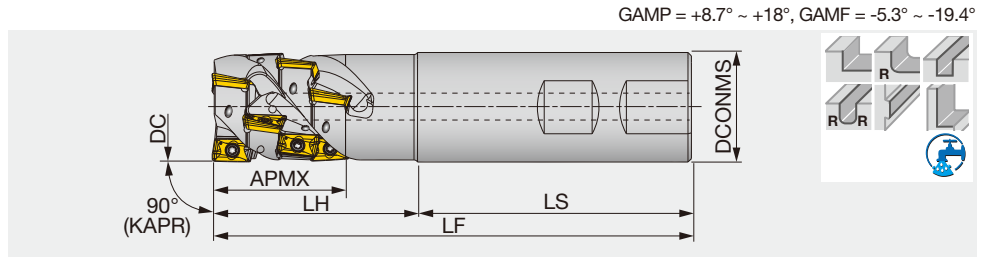

Designation	APMX	DC	ZEFP	CICT	DCONMS	LS	LH	LF	WT(kg)	Air hole	Insert
ELS11R025M25.0W02	30.4	25	2	6	25	80	40	120	0.4	With	AS*T11T3...
ELS11R032M32.0W03	39.4	32	3	12	32	80	60	140	0.8	With	AS*T11T3...
ELS11R040M42.0W03	40	40	3	12	42	90	60	150	1.4	With	AS*T11T3...

TLS11

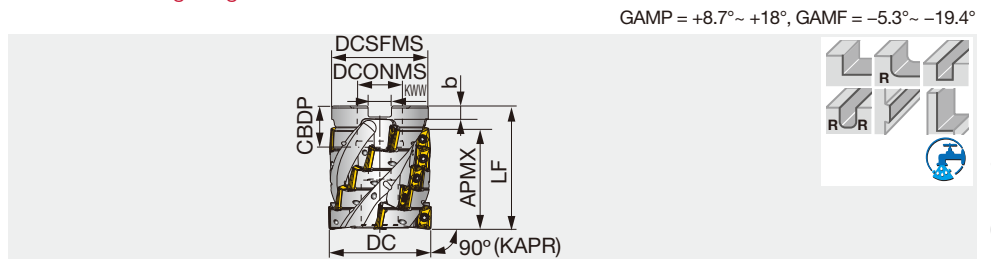

Designation	APMX	DC	ZEFP	CICT	DCSFMS	LF	DCONMS	CBDP	KWW	b	WT(kg)	Air hole	Insert
TLS11R050M22.0E04	48.8	50	4	20	47	60	22	20	10.4	6.3	0.5	With	AS*T11T3...

Note: Coolant needs to be supplied from the end of the arbor inlay. Coolant cannot be supplied from the set bolt.

SPARE PARTS

Designation	Clamping screw	Lubricant	Shell locking bolt	Wrench
ELS11...	CSPB-2.5	M-1000	-	IP-8D
TLS11R050M22.0E04	CSPB-2.5	M-1000	CM10X40H	IP-8D

Recommended clamping torque: 1.3 N·m

- High Feed Milling
- Face Milling
- Shoulder Milling
- Slot Milling
- Profile Milling
- Chamfering, Counterbore
- Finish Face Milling
- Approach angle
- 7°-25°
- 41°-45°
- 60°-70°
- 85°-88°
- 90°
- Others

INSERT

AOMT07-MJ

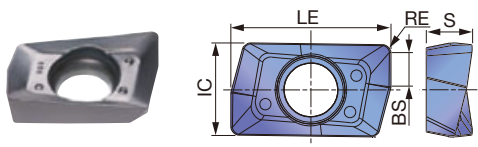

AOMT07-HJ

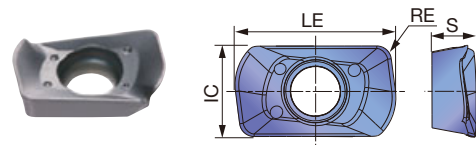

AOGT07-AJ

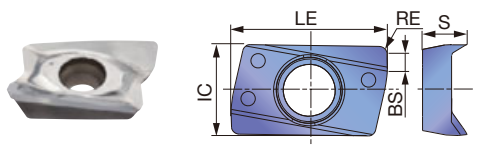

ASMT11-MJ

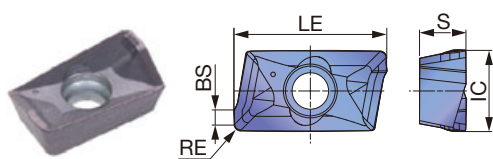

ASMT11-MS

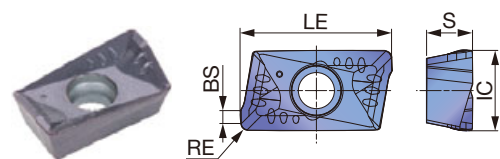

ASGT11-AJ

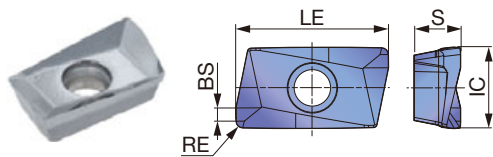

ASGW11-D

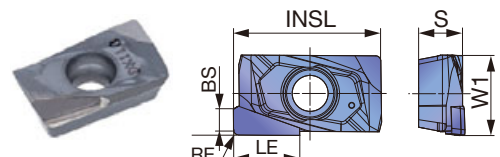

AOMT18-MJ

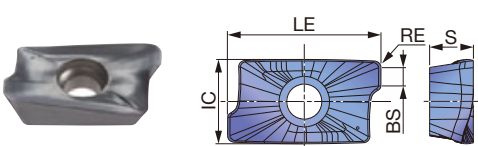

AOGT18-AJ

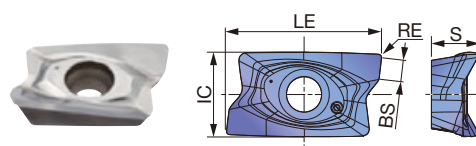

P	Steel	☆			☆	★	☆			★										
M	Stainless		☆	☆	☆	★	☆													
K	Cast iron	★			☆	☆	☆													
N	Non-ferrous																			
S	Superalloys		★		★	☆														
H	Hard materials				★															

★ : First choice
☆ : Second choice

Designation	RE	APMX	Coated							Cermet	Uncoated	PCD		LE	INSL	IC	W1	S	BS
			AH120	AH130	AH140	AH725	AH3225	T3225	T1215			DS1100	NS740						
AOMT070202PDPR-MJ	0.2	7			●	●								8	-	4.7	-	2.3	2.12
AOMT070204PDPR-MJ	0.4	7			●	●								8	-	4.7	-	2.3	1.85
AOMT070208PDPR-MJ	0.8	7			●	●								8	-	4.7	-	2.3	1.52
AOMT070216PDPR-MJ	1.6	7			●	●								8	-	4.7	-	2.3	0.69
AOMT070208PDPR-HJ	0.8	0.8			●	●								8.8	-	4.9	-	2.4	-
AOGT070204PDRF-AJ	0.4	6.4								●				8.1	-	4.7	-	2.3	1.85
ASMT11T304PDPR-MJ	0.4	10.6	●	●		●	●	●	●	●				12.3	-	6.7	-	3.7	1.4
ASMT11T308PDPR-MJ	0.8	10.6	●	●		●	●	●	●	●				12.3	-	6.7	-	3.7	1.4
ASMT11T312PDPR-MJ	1.2	10.6	●	●		●	●	●						12.3	-	6.7	-	3.7	1
ASMT11T316PDPR-MJ	1.6	10.6	●	●		●	●	●	●	●				12.3	-	6.7	-	3.7	0.6
ASMT11T320PDPR-MJ	2	10.6	●				●	●						12.3	-	6.7	-	3.7	0.5
ASMT11T330PDPR-MJ	3	10.6	●	●			●	●	●					12.3	-	6.7	-	3.7	0.2
ASMT11T304PDPR-MS	0.4	10.6		●	●		●							12.3	-	6.7	-	3.7	1.4
ASGT11T304PDRF-AJ	0.4	10.6							●					12.3	-	6.7	-	3.7	1.4
ASGT11T308PDRF-AJ	0.8	10.6							●					12.3	-	6.7	-	3.7	1.4
ASGW11T302PDRF-D	0.2	4.5										●		5.2	11.8	-	6.4	3.7	1.8
ASGW11T304PDRF-D	0.4	4.5										●		5.2	11.8	-	6.4	3.7	1.6
AOMT180508PDPR-MJ	0.8	16.7			●	●								19.5	-	10.7	-	5.6	2.33
AOMT180516PDPR-MJ	1.6	16.7			●	●								19.5	-	10.7	-	5.6	1.58
AOMT180524PDPR-MJ	2.4	16.7			●	●								19.5	-	10.7	-	5.6	1.53
AOMT180532PDPR-MJ	3.2	16.7			●	●								19.5	-	10.7	-	5.6	-
AOGT180504PDRF-AJ	0.4	16.7								●				19.8	-	10.8	-	6.1	2.33
AOGT180508PDRF-AJ	0.8	16.7								●				19.8	-	10.8	-	6.1	2.33

Caution : The contour radius when using the tool is smaller than the RE value.

If RE is 1.2 mm or more, it will be about 10% smaller than RE.

PCD inserts listed above are not designed to be re-ground and re-used

● : Line up

STANDARD CUTTING CONDITIONS

Please scan below.

e-catalog



EPO07

e-catalog



EPO11

e-catalog



EPO18

e-catalog



HPO07-M

e-catalog



HPO11-M

e-catalog



TPO07

e-catalog



TPO11

e-catalog



TPO18

e-catalog



ELS11

e-catalog



TLS11

CAUTIONARY POINT IN MODIFYING CUTTER BODIES

When using inserts with corner radius
RE ≥ 2.0 mm, standard cutter bodies have
to be modified "R". (Only for TPO11, EPO11,
TLS11, ELS11, HPO11)

About roughing type TLS11, ELS11
From 2nd row onwards, please use insert
with RE = 0.4 or 0.8 mm

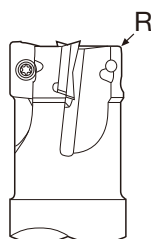

Corner radius RE (mm)	The dimension of modifying (mm)
0.4 ~ 1.6	Unnecessary
2.0 ~ 3.2	2



APPLICATION RANGE

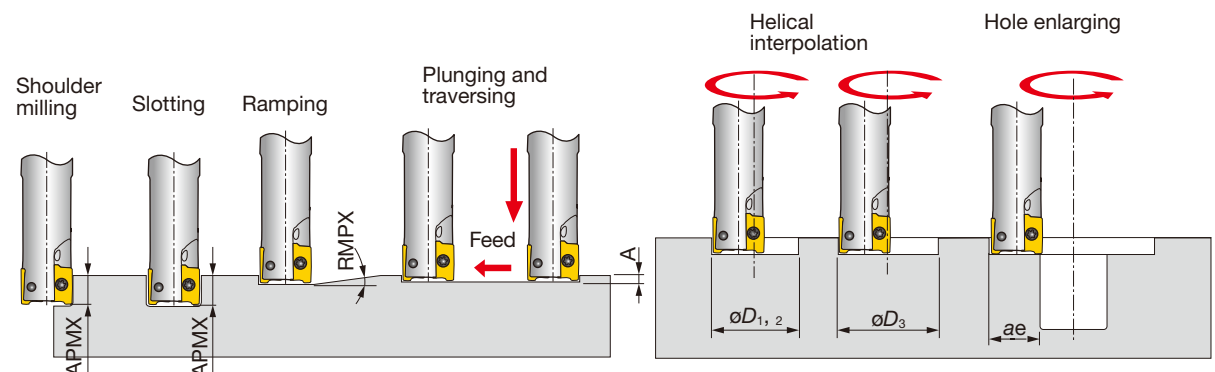

Designation	Tool dia. DC	Chipbreaker	Max. depth of cut APMX	Max. ramping angle RMPX	Max. plunging depth A	Min. machining ϕD_1	Max. machining ϕD_2	ϕD_3^*	Max. cutting width in enlarging ae
E/HPO07R012...	12	MJ	7	8°	0.5	16	23	20.5	11.5
E/HPO07R016...	16	MJ	7	5°	0.5	24	31	28.5	15.5
EPO07R018...	18	MJ	7	4°	0.5	28	35	32.5	17.5
E/HPO07R020...	20	MJ	7	3.5°	0.5	32	39	36.5	19.5
EPO07R022...	22	MJ	7	3°	0.5	36	43	40.5	21.5
E/HPO07R025...	25	MJ	7	2.5°	0.5	42	49	46.5	24.5
EPO07R028...	28	MJ	7	2°	0.5	48	55	52.5	27.5
TPO07R032...	32	MJ	7	1.8°	0.5	56	63	60.5	31.5
TPO07R040	40	MJ	7	1.2°	0.5	72	79	76.5	39.5
TPO07R050...	50	MJ	7	0.9°	0.5	92	99	96.5	49.5
E/HPO07R012...	12	AJ	6.4	8°	0.5	16	23	20.5	11.5
E/HPO07R016...	16	AJ	6.4	5°	0.5	24	31	28.5	15.5
EPO07R018...	18	AJ	6.4	4°	0.5	28	35	32.5	17.5
E/HPO07R020...	20	AJ	6.4	3.5°	0.5	32	39	36.5	19.5
EPO07R022...	22	AJ	6.4	3°	0.5	36	43	40.5	21.5
E/HPO07R025...	25	AJ	6.4	2.5°	0.5	42	49	46.5	24.5
EPO07R028...	28	AJ	6.4	2°	0.5	48	55	52.5	27.5
TPO07R032...	32	AJ	6.4	1.8°	0.5	56	63	60.5	31.5
TPO07R040	40	AJ	6.4	1.2°	0.5	72	79	76.5	39.5
TPO07R050...	50	AJ	6.4	0.9°	0.5	92	99	96.5	49.5
E/HPO07R012...	12.6	HJ	0.8	5°	0.5	17	24	-	9.6
E/HPO07R016...	16.6	HJ	0.8	3°	0.5	25	32	-	13.6
EPO07R018...	18.6	HJ	0.8	2.5°	0.5	29	36	-	15.6
E/HPO07R020...	20.6	HJ	0.8	2.1°	0.5	33	40	-	17.6
EPO07R022...	22.6	HJ	0.8	1.9°	0.5	37	44	-	19.6
E/HPO07R025...	25.6	HJ	0.8	1.6°	0.5	43	50	-	22.6
EPO07R028...	28.6	HJ	0.8	1.3°	0.5	49	56	-	25.6
TPO07R032...	32.6	HJ	0.8	1.1°	0.5	57	64	-	29.6
TPO07R040	40.6	HJ	0.8	0.8°	0.5	73	80	-	37.6
TPO07R050...	50.6	HJ	0.8	0.6°	0.5	93	100	-	47.6
EPO11R012...	12	MJ, MS, AJ	10.6	6°	0.5	15	23	21	11.5
EPO11R016...	16	MJ, MS, AJ	10.6	5°	0.5	20	31	29	15.5
EPO11R018...	18	MJ, MS, AJ	10.6	4°	0.5	26	35	33	17.5
E/HPO11R020...	20	MJ, MS, AJ	10.6	3°	0.5	28	39	37	19.5
EPO11R022...	22	MJ, MS, AJ	10.6	2.5°	0.5	31	43	41	21.5

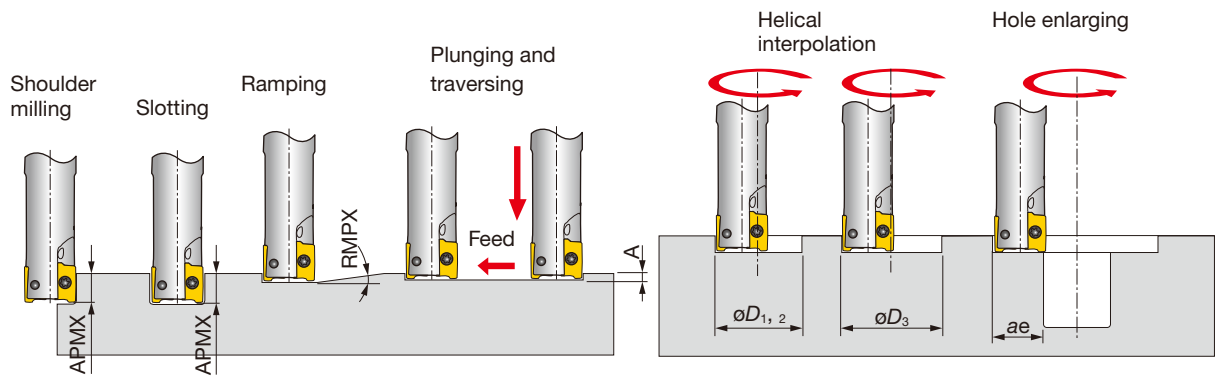

Designation	Tool dia. DC	Chipbreaker	Max. depth of cut APMX	Max. ramping angle RMPX	Max. plunging depth A	Min. machining øD1	Max. machining øD2	øD3*	Max. cutting width in enlarging ae
E/HPO11R025...	25	MJ, MS, AJ	10.6	2°	0.5	38	49	47	24.5
EPO11R028...	28	MJ, MS, AJ	10.6	1.5°	0.5	42	53	51	27.5
EPO11R030...	30	MJ, MS, AJ	10.6	1.5°	0.5	48	55	53	29.5
E/HPO11R032...	32	MJ, MS, AJ	10.6	1.5°	0.5	52	59	57	31.5
EPO11R035...	35	MJ, MS, AJ	10.6	1°	0.5	56	67	65	34.5
E/TPO11R040...	40	MJ, MS, AJ	10.6	1°	0.5	68	79	77	39.5
TPO11R050...	50	MJ, MS, AJ	10.6	0.7°	0.5	68	99	97	49.5
TPO11R063...	63	MJ, MS, AJ	10.6	0.5°	0.5	114	125	123	62.5
TPO11R080...	80	MJ, MS, AJ	10.6	0.4°	0.5	148	159	157	79.5
TPO11R100...	100	MJ, MS, AJ	10.6	0.3°	0.5	188	199	197	99.5
EPO18R025...	25	MJ, AJ	16.7	6°	1	32	48	44	24
EPO18R028...	28	MJ, AJ	16.7	4.5°	1	38	54	50	27
EPO18R030...	30	MJ, AJ	16.7	4°	1	42	58	54	29
EPO18R032...	32	MJ, AJ	16.7	3.5°	1	46	62	58	31
EPO18R035...	35	MJ, AJ	16.7	3°	1	52	68	64	34
E/TPO18R040...	40	MJ, AJ	16.7	2.5°	1	62	78	74	39
E/TPO18R050...	50	MJ, AJ	16.7	1.9°	1	82	98	94	49
E/TPO18R063	63	MJ, AJ	16.7	1.4°	1	108	124	120	62
TPO18R080...	80	MJ, AJ	16.7	1°	1	142	158	154	79
TPO18R100...	100	MJ, AJ	16.7	0.8°	1	182	198	194	99
TPO18R125...	125	MJ, AJ	16.7	0.6°	1	232	248	244	124
TPO18R160...	160	MJ, AJ	16.7	0.4°	1	302	318	314	159

*Flat bottom hole

Note: Corner RE for dimensions of øD1, øD2, and øD3: RE = 0.4 for EPO07 / EPO11 and RE = 0.8 for EPO18.

- High Feed Milling
- Face Milling
- Shoulder Milling
- Slot Milling
- Profile Milling
- Chamfering, Counterbore
- Finish Face Milling
- Approach angle
- 7°-25°
- 41°-45°
- 60°-70°
- 85°-88°
- 90°
- Others

TUNGQUAD

EPD05

High density square shoulder endmill, shank type, with screw clamp system

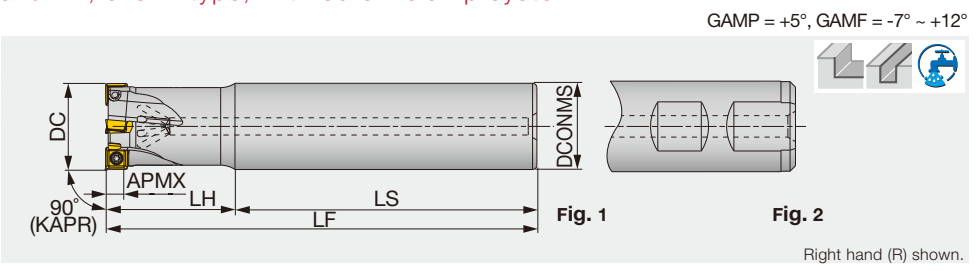

Designation	APMX	DC	CICT	DCONMS	LS	LH	LF	WT(kg)	Air hole	Shank	Insert	Shank type
EPD05R012M12.0-02	4	12	2	12	62	18	80	0.1	With	Straight	SD*T0502...	Fig .1
EPD05R016M16.0-03	4	16	3	16	90	20	110	0.2	With	Straight	SD*T0502...	Fig .1
EPD05R020M20.0W04	4	20	4	20	80	25	105	0.2	With	Weldon	SD*T0502...	Fig .2
EPD05R025M20.0W05	4	25	5	20	90	25	115	0.3	With	Weldon	SD*T0502...	Fig .2
EPD05R032M25.0W06	4	32	6	25	98	32	130	0.5	With	Weldon	SD*T0502...	Fig .2
EPD05R040M32.0W08	4	40	8	32	100	40	140	0.8	With	Weldon	SD*T0502...	Fig .2

TPD05

High density square shoulder mill, with screw clamp system

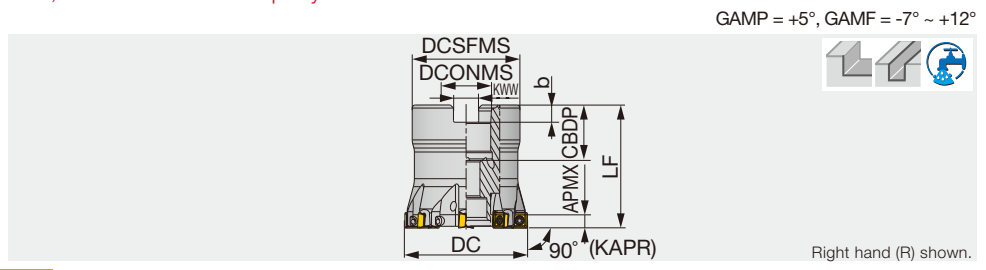

Designation	APMX	DC	CICT	DCSFMS	LF	DCONMS	CBDP	KWW	b	WT(kg)	Air hole	Insert
TPD05R032M16.0E06	4	32	6	30	32	16	20	8.4	5.6	0.1	With	SD*T0502...
TPD05R040M22.0E08	4	40	8	38	40	22	22	10.4	6.3	0.2	With	SD*T0502...

ELD05

High density square shoulder endmill for roughing, shank type, with screw clamp system

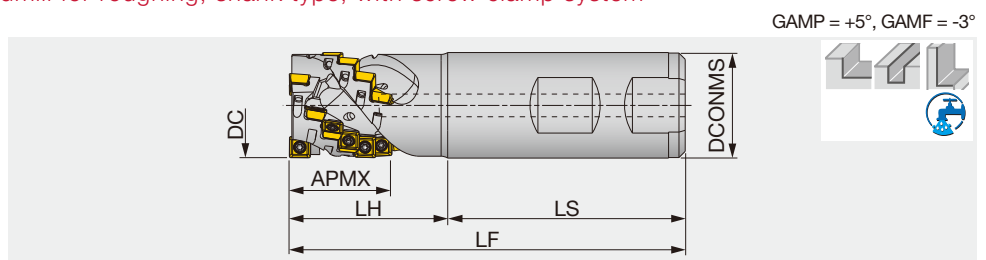

Designation	APMX	DC	ZEFP	CICT	DCONMS	LS	LH	LF	WT(kg)	Air hole	Insert
ELD05R020M20.0W02	20.3	20	2	10	20	53	32	85	0.2	With	SD*T0502...
ELD05R025M25.0W03	24.2	25	3	18	25	59	36	95	0.3	With	SD*T0502...

SPARE PARTS

Designation	Clamping screw	Shell locking bolt	Wrench
EPD05..., ELD05...	CSPB-2L043	-	IP-6DB
TPD05R032M16.0E06	CSPB-2L043	CM8X30H	IP-6DB
TPD05R040M22.0E08	CSPB-2L043	CM10X30H	IP-6DB

Recommended clamping torque: 0.7 N·m

INSERT

SDMT05-MJ

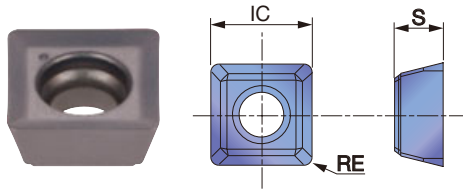

SDHT05-AJ

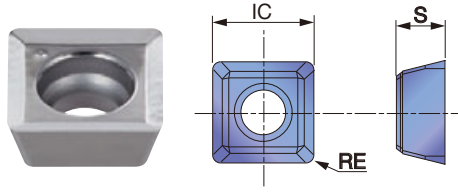

P	Steel		★						
M	Stainless	★	☆						
K	Cast iron		★						
N	Non-ferrous			★					
S	Superalloys		★						
H	Hard materials								

★ : First choice
☆ : Second choice

Designation	RE	APMX	Coated		Uncoated	S	IC
			AH140	AH725	TH10		
SDMT050204PN-MJ	0.4	4	●	●		2.38	5.09
SDHT050204FN-AJ	0.4	4			●	2.39	5.09

● : Line up

STANDARD CUTTING CONDITIONS

Please scan below.

e-catalog



EPD05

e-catalog



TPD05

e-catalog



ELD05

Grade
Insert
Ext. Toolholder
Int. Toolholder
Threading
Grooving
Miniature tool
Milling cutter
Endmill
Drilling tool
Tooling System
User's Guide
Index



- High Feed Milling
- Face Milling
- Shoulder Milling
- Slot Milling
- Profile Milling
- Chamfering, Counterbore
- Finish Face Milling

Square shoulder endmill, with screw clamp system

GAMP = +4.2°~ +4.7°, GAMF = -15.4°~ -11.2°

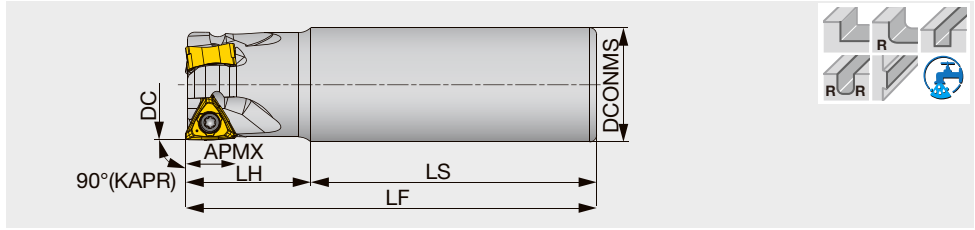

Designation	APMX	DC	CICT	DCONMS	LS	LH ⁽¹⁾	LF ⁽¹⁾	WT(kg)	Air hole	Insert
EPTN07M018C16.0R02	6.5	18	2	16	60	25	85	0.13	With	TN MU07...
EPTN07M020C20.0R02	6.5	20	2	20	70	30	100	0.22	With	TN MU07...
EPTN07M020C20.0R02L	6.5	20	2	20	135	50	185	0.41	With	TN MU07...
EPTN07M020C20.0R03	6.5	20	3	20	70	30	100	0.215	With	TN MU07...
EPTN07M025C25.0R03	6.5	25	3	25	80	35	115	0.41	With	TN MU07...
EPTN07M025C25.0R03L	6.5	25	3	25	150	70	220	0.78	With	TN MU07...
EPTN07M025C25.0R04	6.5	25	4	25	80	35	115	0.41	With	TN MU07...
EPTN07M032C32.0R04	6.5	32	4	32	80	35	115	0.66	With	TN MU07...
EPTN07M032C32.0R05	6.5	32	5	32	80	35	115	0.67	With	TN MU07...
EPTN12M032C32.0R02N	11	32	2	32	80	35	115	0.7	Without	TN*U12...
EPTN12M032C32.0R03N	11	32	3	32	80	35	115	0.7	Without	TN*U12...
EPTN12M040C32.0R03N	11	40	3	32	80	35	115	0.8	Without	TN*U12...
EPTN12M040C32.0R04N	11	40	4	32	80	35	115	0.8	Without	TN*U12...

(1) The value is true with R0.8 insert. For other Corner R, please refer to page H152.

SPARE PARTS

Designation	Clamping screw	Grip	Wrench	Torx bit	Lubricant
EPTN07...	CSPB-2.5SH	-	IP-7D	-	-
EPTN12...	CSPB-3.5	H-TB2W	-	BLDIP15/S7	M-1000

Recommended clamping torque: CSPB-2.5SH = 1.1 N·m, CSPB-3.5 = 3.5 N·m

Approach angle

- 7°-25°
- 41°-45°
- 60°-70°
- 85°-88°
- 90°
- Others

Reference pages: Inserts → H152, Standard cutting conditions → H153

Square shoulder mill, with screw clamp system

GAMP = +4.2°~ +4.7°, GAMF = -15.4°~ -11.2°

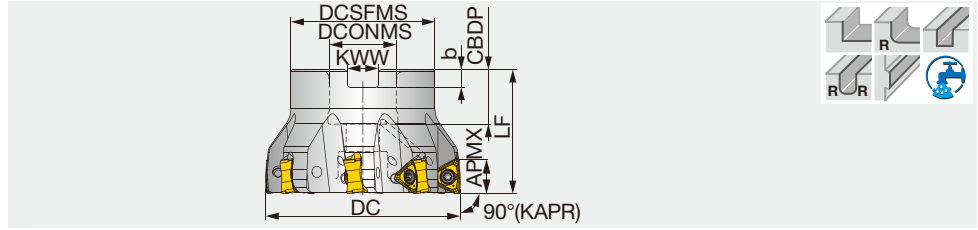

Designation	APMX	DC	CICT	DCSFMS	LF ⁽¹⁾	DCONMS	CBDP	KWW	b	WT(kg)	Air hole	Shell locking bolt	Insert
TPTN07M040B16.0R06	6.5	40	6	35	40	16	18	8.4	5.6	0.24	With	CM8X30H	TN*U07...
TPTN07M050B22.0R08	6.5	50	8	47	40	22	20	10.4	6.3	0.41	With	CM10X30H	TN*U07...
TPTN12M050B22.0R04	11	50	4	47	40	22	20	10.4	6.3	0.4	With	CM10X30H	TN*U12...
TPTN12M050B22.0R05	11	50	5	47	40	22	20	10.4	6.3	0.4	With	CM10X30H	TN*U12...
TPTN12M063B22.0R05	11	63	5	47	40	22	20	10.4	6.3	0.6	With	CM10X30H	TN*U12...
TPTN12M063B22.0R06	11	63	6	47	40	22	20	10.4	6.3	0.6	With	CM10X30H	TN*U12...
TPTN12J080B25.4R06	11	80	6	58	50	25.4	26	9.5	6	1.1	With	CM12X30H	TN*U12...
TPTN12J080B25.4R08	11	80	8	58	50	25.4	26	9.5	6	1.1	With	CM12X30H	TN*U12...
TPTN12M080B27.0R06	11	80	6	58	50	27	22	12.4	7	1.1	With	CM12X30H	TN*U12...
TPTN12M080B27.0R08	11	80	8	58	50	27	22	12.4	7	1.1	With	CM12X30H	TN*U12...
TPTN12J100B31.7R07	11	100	7	67	50	31.75	32	12.7	8	1.4	With	TMBA-M16H	TN*U12...
TPTN12J100B31.7R10	11	100	10	67	50	31.75	32	12.7	8	1.4	With	TMBA-M16H	TN*U12...
TPTN12M100B32.0R07	11	100	7	67	50	32	28.5	14.4	8	1.4	With	TMBA-M16H	TN*U12...
TPTN12M100B32.0R10	11	100	10	67	50	32	28.5	14.4	8	1.4	With	TMBA-M16H	TN*U12...
TPTN12J125B38.1R08	11	125	8	71	63	38.1	38	15.9	10	2.4	With	TMBA-M20H	TN*U12...
TPTN12J125B38.1R12	11	125	12	71	63	38.1	38	15.9	10	2.5	With	TMBA-M20H	TN*U12...
TPTN12M125B40.0R08	11	125	8	71	63	40	32	16.4	9	2.3	With	TMBA-M20H	TN*U12...
TPTN12M125B40.0R12	11	125	12	71	63	40	32	16.4	9	2.4	With	TMBA-M20H	TN*U12...
TPTN12M160B40.0R10N	11	160	10	100	63	40	29	16.4	9	4.5	Without	-	TN*U12...
TPTN12J160B50.8R10N	11	160	10	100	63	50.8	41	19	11	4.5	Without	-	TN*U12...

(1) The value is true with R0.8 insert. For other Corner R, please refer to page H152.

SPARE PARTS

Designation	Clamping screw	Grip	Wrench	Torx bit	Lubricant	Shell locking bolt 1	Shell locking bolt 2
TPTN07...	CSPB-2.5SH	-	IP-7D	-	-	-	-
TPTN12M050, 063B...	CSPB-3.5	H-TB2W	-	BLDIP15/S7	M-1000	-	CM10X30H
TPTN12*080B...	CSPB-3.5	H-TB2W	-	BLDIP15/S7	M-1000	-	CM12X30H
TPTN12*100B...	CSPB-3.5	H-TB2W	-	BLDIP15/S7	M-1000	TMBA-M16H	-
TPTN12*125B...	CSPB-3.5	H-TB2W	-	BLDIP15/S7	M-1000	TMBA-M20H	-
TPTN12*160B...	CSPB-3.5	H-TB2W	-	BLDIP15/S7	M-1000	-	-

Recommended clamping torque: CSPB-2.5SH = 1.1 N-m, CSPB-3.5 = 3.5 N-m





INSERT

TNMU07-MJ

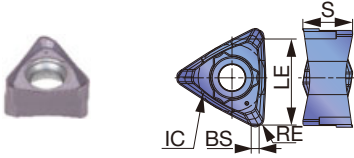

TNGU12-MJ/TNMU12-MJ



TNMU12-NMJ

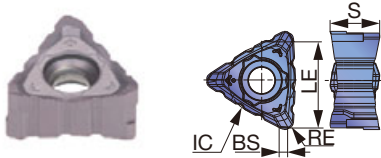

TNMU12-R-MJ

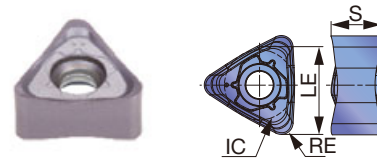

	P	M	K	N	S	H
Steel	☆	★	☆	☆	☆	☆
Stainless		☆	★			☆
Cast iron	★	☆	☆			☆
Non-ferrous						
Superalloy	★		☆			
Hard materials						

★ : First choice
☆ : Second choice

Designation	RE	APMX	Coated					LE	IC	S	BS					
			AH120	AH3225	AH3135	T1215	T3225									
TNMU070304PER-MJ	0.4	6.5	●	●	●							6.5	5.7	4.1	0.6	
TNMU070308PER-MJ	0.8	6.5	●	●	●								6.5	5.7	4.1	0.6
TNGU120708PER-MJ	0.8	11	●	●	●	●							12	9.525	7.04	1.16
TNMU120708PER-MJ	0.8	11	●	●	●	●	●						12	9.525	7.1	1.16
TNMU120708PER-NMJ	0.8	11	●	●	●								12	9.525	7.1	1.16
TNMU1207R16PER-MJ	1.6	11	●	●	●								12	9.525	6.88	-
TNMU1207R20PER-MJ	2	11	●	●	●	●							12	9.525	6.72	-

● : Line up

Notes

LF and LH dimensions for R0.4, size 07 insert

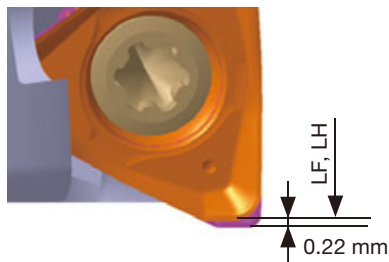

Add 0.22 mm to LH and LF measurements when R0.4 insert is used.

Serrated size 12 insert (NMJ)

To obtain good wall accuracy, the serrated inserts must be arranged in alternative orders on the cutter so that the same serrated edge will not cut the same surface twice, generating steps on the wall. One of the serration grooves (marked in red) on the cutting edge has a irregular shape, and this must be placed alternatively as shown below by A and B.

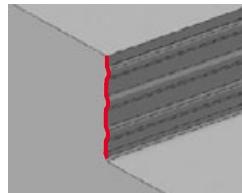

Check the insert orientations if steps are produced on the wall surface.

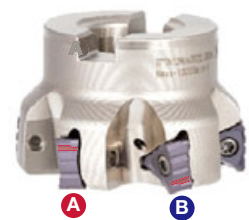

The groove in red is asymmetric for easy identification

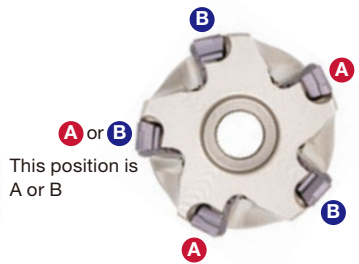

This position is A or B

Insert orientation for odd number of teeth

LF and LH dimensions for R1.6 / 2, size 12 insert

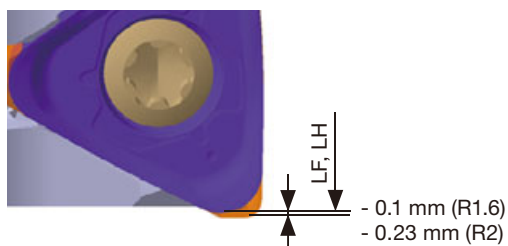

Subtract 0.1 mm (R1.6) or 0.23 mm (R2) to LH and LF measurements when R1.6 or R2 insert is used.

STANDARD CUTTING CONDITIONS

Size 07 inserts

ISO	Workpiece material	Hardness	Priority	Grade	Cutting speed Vc (m/min)	Feed per tooth fz (mm/t)
P	Carbon steel SS400, S15C, etc. E275A, C15E4, etc.	- 200 HB	First choice	AH3225	100 - 250	0.07 - 0.2
			For fracture resistance	AH3135	100 - 250	0.07 - 0.2
	High Carbon steel, Alloy steel S45C, SCM440, etc. C45, 42CrMo4, etc.	- 300 HB	First choice	AH3225	100 - 230	0.07 - 0.15
			For fracture resistance	AH3135	100 - 230	0.07 - 0.15
	Prehardened steel NAK80, PX5, etc.	30 - 40 HRC	First choice	AH3225	100 - 180	0.07 - 0.15
			For fracture resistance	AH3135	100 - 180	0.07 - 0.15
M	Stainless steel SUS304, etc. X5CrNi18-9, etc.	- 200 HB	First choice	AH3135	90 - 200	0.07 - 0.15
			For wear resistance	AH3225	90 - 200	0.07 - 0.15
K	Grey cast iron FC250, etc. 250, etc.	150 - 250 HB	First choice	AH120	140 - 250	0.07 - 0.2
			For fracture resistance	AH3225	140 - 250	0.07 - 0.2
	Ductile cast iron FCD450, etc. 450-10S, etc.	150 - 250 HB	First choice	AH120	110 - 200	0.07 - 0.15
			For fracture resistance	AH3225	110 - 200	0.07 - 0.15
S	Titanium alloys Ti-6Al-4V, etc.	- 40 HRC	First choice	AH3135	20 - 60	0.07 - 0.15
	Heat-resistant alloys Inconel 718, etc.	- 40 HRC	First choice	AH120	20 - 40	0.07 - 0.1

Size 12 inserts

ISO	Workpiece material	Hardness	Priority	Grade	Chipbreaker	Cutting speed Vc (m/min)	Feed per tooth fz (mm/t)
P	Carbon steel SS400, S15C, etc. E275A, C15E4, etc.	- 200 HB	First choice	AH3225	MJ	100 - 250	0.08 - 0.3
			For fracture resistance	AH3135	MJ	100 - 250	0.08 - 0.3
			For wear resistance	T3225	MJ	100 - 300	0.08 - 0.3
	High Carbon steel, Alloy steel S45C, SCM440, etc. C45, 42CrMo4, etc.	- 300 HB	Low cutting force	AH3225	NMJ	100 - 250	0.08 - 0.14
			First choice	AH3225	MJ	100 - 230	0.08 - 0.3
			For fracture resistance	AH3135	MJ	100 - 230	0.08 - 0.3
			For wear resistance	T3225	MJ	100 - 280	0.08 - 0.3
			Low cutting force	AH3225	NMJ	100 - 230	0.08 - 0.14
			First choice	AH3225	MJ	100 - 180	0.08 - 0.25
	Prehardened steel NAK80, PX5, etc.	30 - 40 HRC	For fracture resistance	AH3135	MJ	100 - 180	0.08 - 0.25
			For wear resistance	T3225	MJ	100 - 200	0.08 - 0.25
			Low cutting force	AH3225	NMJ	100 - 180	0.08 - 0.14
M	Stainless steel SUS304, etc. X5CrNi18-9, etc.	- 200 HB	First choice	AH3135	MJ	90 - 200	0.08 - 0.25
			For wear resistance	T3225	MJ	90 - 250	0.08 - 0.25
			Low cutting force	AH3135	NMJ	90 - 200	0.08 - 0.14
K	Grey cast iron FC250, etc. 250, etc.	150 - 250 HB	First choice	AH120	MJ	140 - 250	0.08 - 0.3
			For fracture resistance	AH3225	MJ	140 - 250	0.08 - 0.3
			For wear resistance	T1215	MJ	140 - 300	0.08 - 0.3
	Ductile cast iron FCD450, etc. 450-10S, etc.	150 - 250 HB	Low cutting force	AH120	NMJ	140 - 250	0.08 - 0.14
			First choice	AH120	MJ	110 - 200	0.08 - 0.25
			For fracture resistance	AH3225	MJ	110 - 200	0.08 - 0.25
S	Titanium alloys Ti-6Al-4V, etc.	- 40 HRC	For wear resistance	T1215	MJ	110 - 250	0.08 - 0.25
			Low cutting force	AH120	NMJ	110 - 200	0.08 - 0.14
			First choice	AH120	MJ	20 - 40	0.07 - 0.18
S	Heat-resistant alloys Inconel 718, etc.	- 40 HRC	Low cutting force	AH120	NMJ	20 - 40	0.07 - 0.14
			First choice	AH120	MJ	20 - 40	0.07 - 0.18

Note: For NMJ chipbreaker, use a feed rate that satisfies the following theoretical chip thickness:

Designation	Chip thickness (mm)
TNMMU120708PER-NMJ	< 0.2





DOREC EPQ11,18

Square shoulder endmill, shank type, with screw clamp system

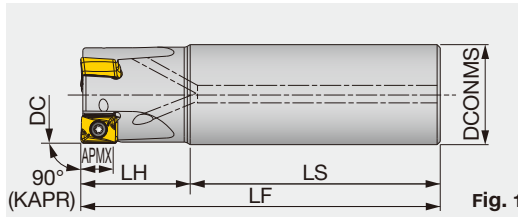

Fig. 1

GAMP = +4° ~ +5°, GAMF = +13° ~ +15°

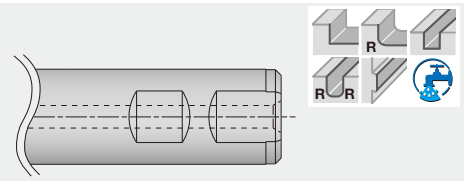

Fig. 2

Right hand (R) shown.

Designation	APMX	DC	CICT	DCONMS	LS	LH	LF	WT(kg)	Air hole	Insert	Shank type
EPQ11R025M25.0-02	9	25	2	25	70	30	100	0.3	With	LQMU1107...	Fig.1
EPQ11R032M32.0-03	9	32	3	32	80	35	115	0.7	With	LQMU1107...	Fig.1
EPQ11R040M32.0-04	9	40	4	32	80	35	115	0.8	With	LQMU1107...	Fig.1
EPQ18R040M32.0W03	16	40	3	32	75	35	110	0.7	With	LQMU1808...	Fig.2
EPQ11R050M32.0-05	9	50	5	32	80	40	120	0.9	With	LQMU1107...	Fig.1
EPQ18R050M32.0W04	16	50	4	32	75	40	115	0.9	With	LQMU1808...	Fig.2
EPQ11R063M32.0-06	9	63	6	32	80	40	120	1.1	With	LQMU1107...	Fig.1
EPQ11R080M32.0-07	9	80	7	32	80	40	120	1.4	With	LQMU1107...	Fig.1

TPQ11,18

Square shoulder mill, with screw clamp system

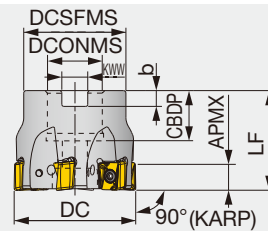

GAMP = +4° ~ +5°, GAMF = +13° ~ +15°



Right hand (R) shown.

Designation	APMX	DC	CICT	DCSFMS	LF	DCONMS	CBDP	KWW	b	WT(kg)	Air hole	Insert
TPQ11R040M16.0E04	9	40	4	35	40	16	20	8.4	5.6	0.2	With	LQMU1107...
TPQ11R050M22.0E06	9	50	6	41	40	22	20	10.4	6.3	0.4	With	LQMU1107...
TPQ18R050M22.0E03	16	50	3	47	40	22	20	10.4	6.3	0.4	With	LQMU1808...
TPQ11R063M22.0E07	9	63	7	47	40	22	20	10.4	6.3	0.5	With	LQMU1107...
TPQ18R063M25.4-04	16	63	4	55	50	25.4	26	9.5	6	0.7	With	LQMU1808...
TPQ18R063M27.0E04	16	63	4	58	50	27	26	12.4	7	0.5	With	LQMU1808...
TPQ11R080M25.4-10	9	80	10	55	50	25.4	26	9.5	6	1.1	With	LQMU1107...
TPQ11R080M27.0E10	9	80	10	58	50	27	26	12.4	7	1	With	LQMU1107...
TPQ18R080M25.4-05	16	80	5	55	50	25.4	26	9.5	6	0.9	With	LQMU1808...
TPQ18R080M27.0E05	16	80	5	58	50	27	26	12.4	7	0.9	With	LQMU1808...
TPQ11R100M31.7-12	9	100	12	66	50	31.75	32	12.95	8	1.6	With	LQMU1107...
TPQ11R100M32.0E12	9	100	12	66	50	32	32	14.4	8	1.6	With	LQMU1107...
TPQ18R100M31.7-06	16	100	6	70	50	31.75	32	12.95	8	1.4	With	LQMU1808...
TPQ18R100M32.0E06	16	100	6	66	50	32	32	14.4	8	1.4	With	LQMU1808...
TPQ18R125M38.1-08	16	125	8	80	63	38.1	38	15.9	10	2.9	With	LQMU1808...
TPQ18R125M40.0E08	16	125	8	82	63	40	38	16.4	9	2.9	With	LQMU1808...
TPQ18R160M50.8-09	16	160	9	100	63	50.8	38	19	11	4.1	Without	LQMU1808...
TPQ18R160M40.0E09	16	160	9	100	63	40	38	16.4	9	4.1	Without	LQMU1808...

Reference pages: Standard cutting conditions → **H156**

SPARE PARTS

Designation	Clamping screw	Grip 1	Grip 2	Torx bit	Shell locking bolt	Wrench
EPQ11...	CSTB-3.5L115	SW6-SD	-	BLDT10/S7	-	T-10D
EPQ18...	SR14-591	-	H-TB	BT20M	-	T-20D
TPQ11R040M...	CSTB-3.5L115	SW6-SD	-	BLDT10/S7	CM8x30H	-
TPQ11R050M..., 063M...	CSTB-3.5L115	SW6-SD	-	BLDT10/S7	CM10x30H	-
TPQ11R080M...	CSTB-3.5L115	SW6-SD	-	BLDT10/S7	CM12x30H	-
TPQ11R100M...	CSTB-3.5L115	SW6-SD	-	BLDT10/S7	TMBA-M16H	-
TPQ18R050M...	SR14-591	-	H-TB	BT20M	CM10x30H	-
TPQ18R063M..., 080M...	SR14-591	-	H-TB	BT20M	CM12x30H	-
TPQ18R100M...	SR14-591	-	H-TB	BT20M	TMBA-M16H	-
TPQ18R125M...	SR14-591	-	H-TB	BT20M	TMBA-M20H	-
TPQ18R160M...	SR14-591	-	H-TB	BT20M	-	-

Recommended clamping torque : CSTB-3.5L115 = 2.5 N-m, SR14-591 = 5 N-m

INSERT

LQMU11-PXER-MJ

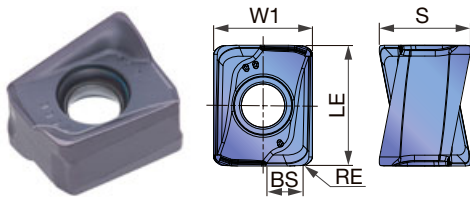

LQMU11/18-PNER-MJ

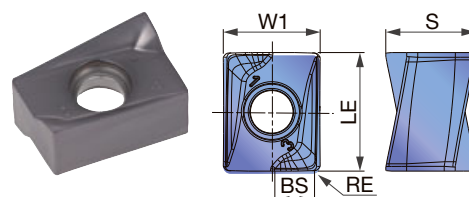

P Steel	☆	★	★	
M Stainless		★	☆	★
K Cast iron	★		☆	
N Non-ferrous				
S Superalloys	★		★	☆
H Hard materials				

★ : First choice
☆ : Second choice

Designation	RE	APMX	Coated				LE	S	W1	BS
			AH120	AH140	AH725	AH3135				
LQMU110704PNER-MJ	0.4	9	●	●	●		11	8.4	9	1.5
LQMU110708PNER-MJ	0.8	9	●	●	●		11	8.3	9	1.1
LQMU110708PXER-MJ	0.8	9	●			●	11	8.3	9	1.1
LQMU110716PNER-MJ	1.6	9	●	●	●		11	8.2	9	0.3
LQMU110720PNER-MJ	2	9	●				11	8.1	9	-
LQMU180804PNER-MJ	0.4	16	●	●	●		17.5	10.9	11.5	2.0
LQMU180808PNER-MJ	0.8	16	●	●	●		17.5	10.9	11.5	1.6
LQMU180816PNER-MJ	1.6	16	●	●	●		17.5	10.9	11.5	0.8
LQMU180824PNER-MJ	2.4	16	●	●	●		17.5	10.7	11.5	-

● : Line up

Grade
Insert
Ext. Toolholder
Int. Toolholder
Threading
Grooving
Miniature tool
Milling cutter
Endmill
Drilling tool
Tooling System
User's Guide
Index



STANDARD CUTTING CONDITIONS

LQMU11-PXER-MJ

ISO	Workpiece material	Hardness	Grade	Cutting speed Vc (m/min)	Feed per tooth fz (mm/t)
P	Low carbon steel S15C, etc. C15E, etc.	- 200 HB	AH3135	100 - 250	0.1 - 0.25*
	Alloy steel S55C, etc. C55, etc.	- 300 HB	AH3135	100 - 230	0.1 - 0.2*
	Prehardened steel NAK80, PX5, etc.	30 - 40 HRC	AH3135	100 - 230	0.1 - 0.2*
M	Stainless steel SUS304, etc. X5CrNi18-9, etc.	- 200 HB	AH3135	90 - 180	0.1 - 0.25*
K	Grey cast iron FC250, etc. 250, etc.	150 - 250 HB	AH120	140 - 250	0.1 - 0.25*
	Ductile cast iron FCD400, etc. 450-10S, etc.	150 - 250 HB	AH120	110 - 200	0.1 - 0.25*
S	Titanium alloys Ti-6Al-4V, etc.	- 40 HRC	AH120	30 - 60	0.08 - 0.2*
	Superalloys Inconel 718, etc.	- 40 HRC	AH120	20 - 50	0.06 - 0.1*
H	Hardened steel	SKD61, etc. X40CrMoV5-1, etc.	AH120	45 - 70	0.08 - 0.15*
		SKD11, etc. X153CrMoV12, etc.	AH120	40 - 65	0.06 - 0.1*

LQMU11/18-PNER-MJ

ISO	Workpiece material	Hardness	Grade	Cutting speed Vc (m/min)	Feed per tooth fz (mm/t)
P	Low carbon steel S15C, etc. C15E, etc.	- 200 HB	AH725	100 - 250	0.1 - 0.25*
	High carbon steel S45C, S55C, etc. C45, C55, etc.	200 - 300 HB	AH725	100 - 230	0.1 - 0.2*
	Alloy steel SCM440, SCR415, etc. 42CrMo4, etc.	- 300 HB	AH725	100 - 230	0.1 - 0.2*
	Tool steel D2, etc. X153CrMoV12, etc.	30 - 40 HRC	AH725	100 - 180	0.1 - 0.2*
M	Stainless steel SUS304, etc. X5CrNi18-9, etc.	- 200 HB	AH140	90 - 180	0.1 - 0.25*
K	Grey cast iron FC250, etc. 250, etc.	150 - 250 HB	AH120	140 - 250	0.1 - 0.25*
	Ductile cast iron FCD400, etc. 450-10S, etc.	150 - 250 HB	AH120	110 - 200	0.1 - 0.25*
S	Superalloys Inconel 718, Ti-6Al-4V, etc.	- 40 HRC	AH725	20 - 50	0.08 - 0.2*

* When using LQMU11 inserts, see page **H157** for proper feed per tooth setting.

- For applications with poor chip evacuation, use air gun to remove chips from the machining area to avoid chip re-cutting and part damage.
- To machine cast surface with unstable cutting depths or interruptions, it is recommended to lower the feed rate (fz) to the lowest parameter in the recommended range.
- Rigidity of the machine and/or workpiece and the spindle power capability greatly influence the cutting conditions. For applications with large cutting width/depth and/or long tool overhang, start with a Vc and fz in the lower range of the recommended cutting parameters and monitor the machine stability.

APPLICATION RANGE

LQMU11-PXER-MJ

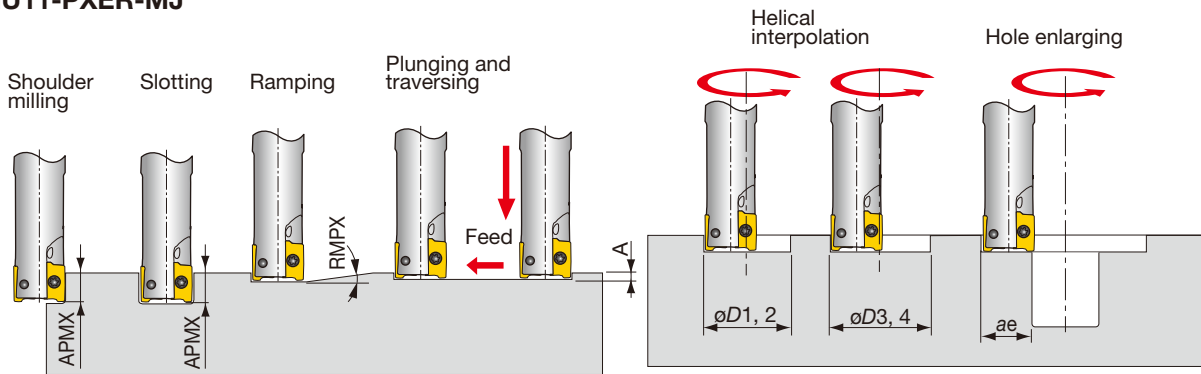

Designation	DC	Max. depth of cut	Max. ramping angle	Max. plunging	Min. machining	Max. machining			Max. cutting width in enlarging	
		APMX	RMPX	A	$\phi D1$	$\phi D2^*$	$\phi D3$	$\phi D4^*$	RE	ae
EPQ11R025...	25	9	1.8°	0.6	35	46.8	49	48.5	0.8	24.1
EPQ11R032...	32	9	1.3°	0.6	48	60.8	63	62.5	0.8	31.1
TPQ11R040...	40	9	0.9°	0.6	64	76.8	79	78.5	0.8	39.1
TPQ11R050...	50	9	0.7°	0.6	84	96.8	99	98.5	0.8	49.1
TPQ11R063...	63	9	0.5°	0.6	110	122.8	125	124.5	0.8	62.1
TPQ11R080...	80	9	0.4°	0.6	144	156.8	159	158.5	0.8	79.1
TPQ11R100...	100	9	0.3°	0.6	184	196.8	199	198.5	0.8	99.1

*For a flat bottom

NOTE WHEN USING LQMU11 INSERTS

Maximum feed rate per tooth varies depending on the cutting depth and width.
Use proper feed rate as described below.
Use caution. Tool may damage if the parameters are not properly set.

Applicable feed rate (for $ae < 10\%$ of tool diameter)

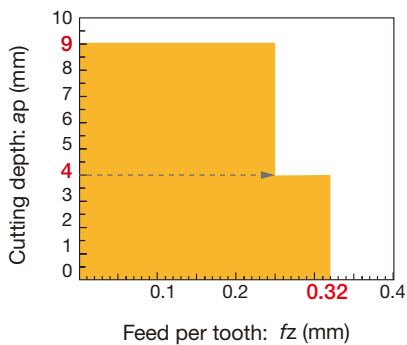

Cutter : TPQ11R050M22.0-06 (DC = 50 mm, z = 6)
Insert : LQMU110708PXER-MJ
Grade : AH3135
Workpiece material : S55C (200HB)
Cutting Speed : $V_c = 200$ m/min
Cutting width : $ae = 5$ mm
Coolant : Dry
Machine : Vertical M/C, 22 kW

Applicable feed rate (for $ae > 10\%$ of tool diameter)

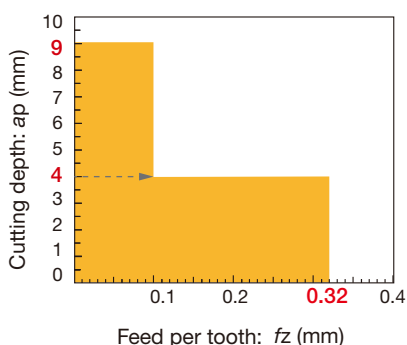

Cutter : TPQ11R050M22.0-06 (DC = 50 mm, z = 6)
Insert : LQMU110708PXER-MJ
Grade : AH3125
Workpiece material : S55C (200HB)
Cutting Speed : $V_c = 200$ m/min
Cutting width : $ae = 42.5$ mm
Coolant : Dry
Machine : Vertical M/C, 22 kW





TUNGSMILL

EPYP12

High speed PCD endmill for non ferrous metal

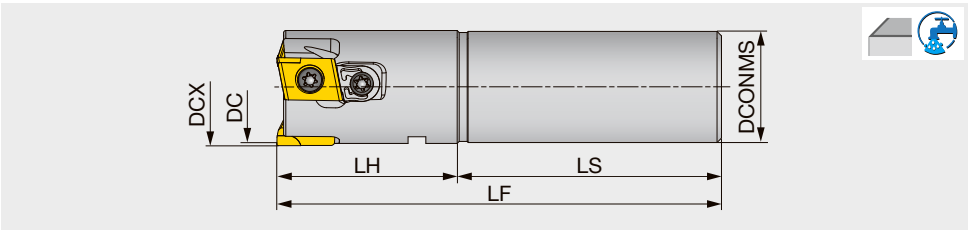

Designation	DC	DCX	CICT	DCONMS	LF	LH	LS	WT(kg)	Air hole	Insert
EPYP12M025C25.0R03	25	26.4	3	25	100	50	50	0.4	With	YPEB12X3-*P...
EPYP12M032C25.0R05	32	33.4	5	25	100	45	55	0.5	With	YPEB12X3-*P...



DCX: Outside diameter
DC: Diameter with 01 type insert

Reference pages: Inserts, Standard cutting conditions → **H095**



DOQMILL

THSN12

88° face mills with double sided square inserts

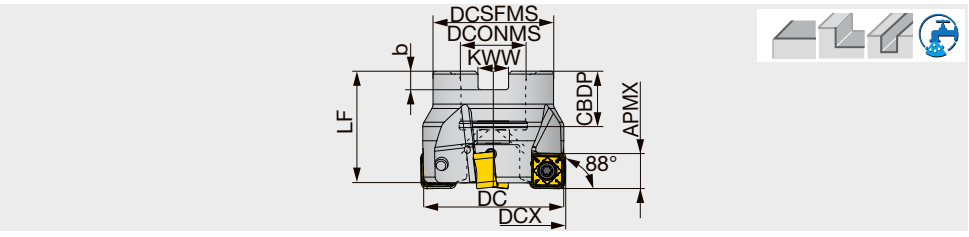

GAMP = +3°, GAMF = -11°

Approach angle



Designation	APMX	DC	DCX	CICT	DCSFMS	LF	DCONMS	CBDP	KWW	b	WT(kg)	Air hole	Insert
THSN12M050B22.0R04	9.5	50	50.6	4	41	40	22	20	10.4	6.3	0.32	with	SNMU1206...
THSN12M050B22.0R05	9.5	50	50.6	5	41	40	22	20	10.4	6.3	0.32	with	SNMU1206...
THSN12M063B22.0R04	9.5	63	63.6	4	47	40	22	20	10.4	6.3	0.54	with	SNMU1206...
THSN12M063B22.0R06	9.5	63	63.6	6	47	40	22	20	10.4	6.3	0.52	with	SNMU1206...
THSN12J080B25.4R05	9.5	80	80.6	5	58	50	25.4	26	9.5	6	1.13	with	SNMU1206...
THSN12J080B25.4R08	9.5	80	80.6	8	58	50	25.4	26	9.5	6	1.15	with	SNMU1206...
THSN12M080B27.0R05	9.5	80	80.6	5	58	50	27	22	12.4	7	1.17	with	SNMU1206...
THSN12M080B27.0R08	9.5	80	80.6	8	58	50	27	22	12.4	7	1.14	with	SNMU1206...
THSN12J100B31.7R06	9.5	100	100.6	6	60	50	31.75	32	12.7	8	1.43	with	SNMU1206...
THSN12J100B31.7R08	9.5	100	100.6	8	60	50	31.75	32	12.7	8	1.39	with	SNMU1206...
THSN12M100B32.0R06	9.5	100	100.6	6	60	50	32	28.5	14.4	8	1.4	with	SNMU1206...
THSN12M100B32.0R08	9.5	100	100.6	8	60	50	32	28.5	14.4	8	1.38	with	SNMU1206...

SPARE PARTS

Designation	Clamping screw 1	Clamping screw 2	Torx bit	Grip	Center bolt	Wrench 1	Wrench 2	Wedge fixing screw	Wedge
EPYP12M025C25.0R03	-	VX040024A	-	-	-	T-15F	T-8F	VX040028A	RSFTC1011
EPYP12M032C25.0R05	-	VX040024A	-	-	-	T-15F	T-8F	RSRGR7M40	RSFTC1009
THSN12M050...	CSPB-4	-	BLDIP15/S7	H-TB2W	CM10x30H	-	-	-	-
THSN12M063...	CSPB-4	-	BLDIP15/S7	H-TB2W	CM12x30H	-	-	-	-
THSN12J080...	CSPB-4	-	BLDIP15/S7	H-TB2W	TMBA-M16H	-	-	-	-
THSN12J100...	CSPB-4	-	BLDIP15/S7	H-TB2W	TMBA-M16H	-	-	-	-

Recommended clamping torque: VX040024A = 4.5 N·m, CSPB-4 = 3.5 N·m

INSERTS

SNMU120608HNEN-MM

SNMU120612/20EN-MM

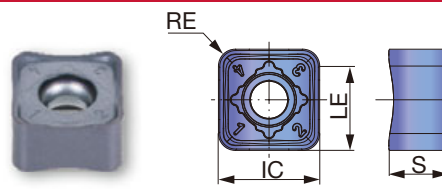
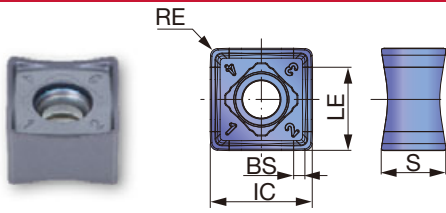

P Steel	☆	★	☆	★	
M Stainless		☆	★	★	
K Cast iron	★	☆	★		
N Non-ferrous					
S Superalloys	★		☆		
H Hard materials					

★ : First choice
☆ : Second choice

Designation	RE	APMX	Coated					LE	S	IC	BS
			AH120	AH3225	AH3135	T1215	T3225				
SNMU120608HNEN-MM	0.8	9.5	●	●	●	●	●	9.8	7.5	12	1.4
SNMU120612EN-MM	1.2	9.5			●	●		10.8	7.25	12	-
SNMU120620EN-MM	2	9.5			●	●		10	7	12	-

● : Line up

STANDARD CUTTING CONDITIONS

ISO	Workpiece materials	Hardness	Priority	Grades	Chip-breaker	Cutting speed Vc (m/min)	Feed per tooth fz (mm/t)
P	Low carbon steels S15C, etc. C15E4, etc., C15E, etc.	- 200HB	First choice	AH3225	MM	100 - 250	0.06 - 0.3
			For wear resistance	T3225	MM	200 - 350	0.06 - 0.25
	High carbon and alloy steel S55C, SCM440, etc. C55, 42CrMo4, etc.	- 300HB	First choice	AH3225	MM	100 - 250	0.06 - 0.3
			For wear resistance	T3225	MM	180 - 300	0.06 - 0.25
M	Austenitic stainless steel SUS304, SUS316, etc. X5CrNi18-9, X5CrNiMo17-12-3, etc.	- 200HB	First choice	AH3135	MM	100 - 200	0.06 - 0.25
			For wear resistance	T3225	MM	100 - 250	0.06 - 0.2
	Cast stainless steel SCH20XNb, 1.4849, etc.	-	First choice	T3225	MM	60 - 120	0.06 - 0.2
			For fracture resistance	AH3135	MM	60 - 120	0.06 - 0.2
K	Grey cast iron FC250, etc. 250, etc., GGG25, etc.	150 - 250HB	First choice	T1215	MM	100 - 350	0.06 - 0.3
			For fracture resistance	AH120	MM	100 - 250	0.06 - 0.3
	Ductile cast iron FCD600, etc. 600-3, etc., GGG60, etc.	150 - 250HB	First choice	T1215	MM	100 - 350	0.06 - 0.25
			For fracture resistance	AH120	MM	80 - 200	0.06 - 0.3
S	Titanium alloys Ti-6Al-4V, etc.	- 40HRC	First choice	AH3135	MM	30 - 60	0.06 - 0.2
	Heat-resistant alloys Inconel718, etc.	- 40HRC	First choice	AH120	MM	10 - 40	0.04 - 0.16
H	Hardened steel SKD61, etc., X40CrMoV5-1, etc.	40 - 50HRC	First choice	AH3225	MM	80 - 130	0.04 - 0.16
	Hardened steel SKD11, etc., X153CrMoV12, etc.	50 - 60HRC	First choice	AH120	MM	50 - 70	0.02 - 0.08

Tool offset

To eliminate uncut amount in face milling operation, adjust the programming according to the offset (L) listed below.

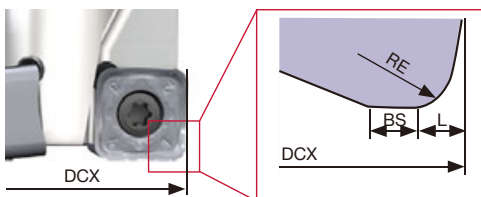

Designation	RE	BS	L
SNMU120608HNEN-MM	0.8	1.4	1.3
SNMU120612EN-MM	1.2	-	1.7
SNMU120620EN-MM	2	-	2.5

The following table shows the amount overcut (t) when the cutter is used as a shoulder milling cutter.

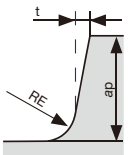

Designation / ap (mm)	1	2	3	4	5	6	7	8	9	9.5
SNMU120608HNEN-MM	0.01	0.04	0.05	0.05	0.07	0.09	0.14	0.2	0.27	0.27
SNMU120612EN-MM	-	0	0	0.01	0.02	0.05	0.09	0.15	0.22	0.25
SNMU120620EN-MM	-	0	0	0	0.02	0.05	0.09	0.15	0.22	0.25



TUNG-ALUMILL

EPV16

90° shoulder endmill for aluminium machining, shank type, with screw clamp system

GAMP = +6° ~ +10°, GAMF = -12° ~ -9°

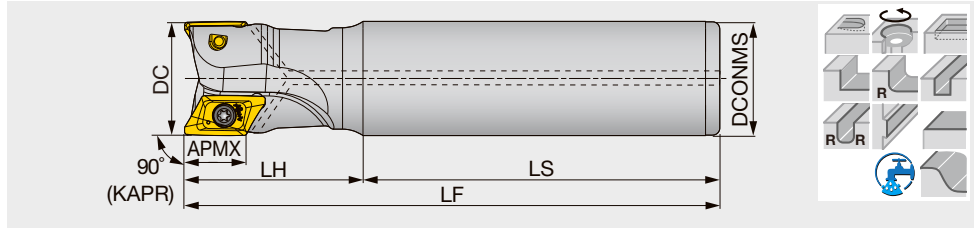

Designation	DC	CICT	DCONMS	LS	LH	LF	WT(kg)	Air hole	Max. RPM (min ⁻¹)	Insert
EPV16R025M25.0-02	25	2	25	70	55	125	0.37	With	38,000	XVCT1605...
EPV16R025M25.0-02L	25	2	25	100	70	170	0.53	With	38,000	XVCT1605...
EPV16R032M32.0-02	32	2	32	100	50	150	0.77	With	34,000	XVCT1605...
EPV16R032M32.0-02L	32	2	32	120	80	200	1.03	With	34,000	XVCT1605...
EPV16R032M32.0-03	32	3	32	100	50	150	0.76	With	34,000	XVCT1605...
EPV16R032M32.0-03L	32	3	32	120	80	200	1.03	With	34,000	XVCT1605...
EPV16R040M32.0-03	40	3	32	115	55	170	0.94	With	30,000	XVCT1605...
EPV16R040M32.0-03L	40	3	32	195	55	250	1.43	With	30,000	XVCT1605...

TPV16

90° shoulder mill for aluminium machining, with screw clamp system

GAMP = +10° ~ +11°, GAMF = -9° ~ -5.5°

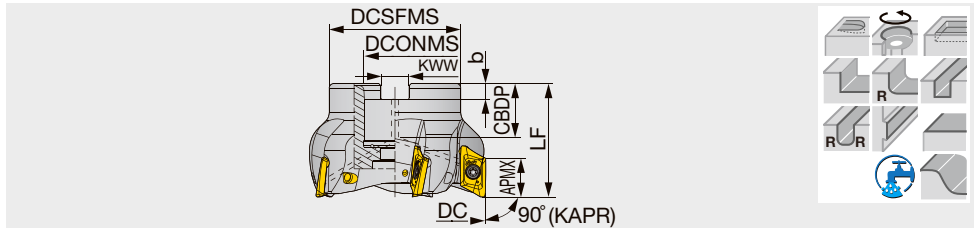

Designation	DC	CICT	DCSFMS	DCONMS	CBDP	LF	b	KWW	WT(kg)	Air hole	Max. RPM (min ⁻¹)	Insert
TPV16R040M16.0E03	40	3	38	16	20	50	5.6	8.4	0.23	With	30,000	XVCT1605...
TPV16R050M22.0E04	50	4	45	22	22	50	6.3	10.4	0.33	With	27,000	XVCT1605...
TPV16R063M22.0E05	63	5	47	22	22	50	6.3	10.4	0.54	With	24,000	XVCT1605...
TPV16R080M27.0E05	80	5	58	27	28	50	7	12.4	0.86	With	21,000	XVCT1605...
TPV16R100M32.0E06	100	6	66	32	26	63	8	14.4	1.55	With	19,000	XVCT1605...
TPV16R125M40.0E07	125	7	85	40	32	63	9	16.4	2.53	With	17,000	XVCT1605...

SPARE PARTS

Designation	Clamping screw	Grip	Shell locking bolt	Torx bit
EPV16R025M...	TS40085I/HG	H-TBS	-	BT15S
EPV16R032M..., 040M...	TS40093I/HG	H-TBS	-	BT15S
TPV16R040M16.0E03	TS40093I/HG	H-TBS	SHM8X1.25X35-C	BT15S
TPV16R050 - 063...	TS40093I/HG	H-TBS	SHM10X1.5X30-C	BT15S
TPV16R080M27.0E05	TS40093I/HG	H-TBS	LHM12X1.75X30-C	BT15S
TPV16R100M32.0E06	TS40093I/HG	H-TBS	SHM16X2X35-C	BT15S
TPV16R125M40.0E07	TS40093I/HG	H-TBS	SHM20X2.5X40-C	BT15S

Recommended clamping torque: 4.5 N·m

INSERT

XVCT16-AJ

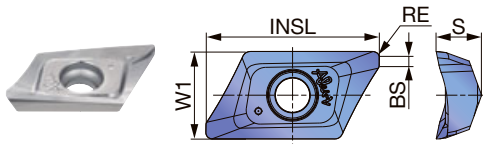

P	Steel		
M	Stainless		
K	Cast iron		
N	Non-ferrous	★	
S	Superalloys		
H	Hard materials		

★ : First choice

Designation	RE	APMX	Uncoated										INSL	W1	S	BS		
			TH10															
XVCT160504R-AJ	0.4	16	●												22.2	11.2	5.9	1.3
XVCT160508R-AJ	0.8	16	●												22.2	11.2	5.9	1
XVCT160512R-AJ	1.2	15.5	●												21.8	11.2	5.8	1
XVCT160516R-AJ	1.6	15	●												21.2	11.2	5.75	1
XVCT160520R-AJ	2	14.5	●												20.8	11.2	5.75	1
XVCT160525R-AJ	2.5	14	●												20.2	11.2	5.68	1
XVCT160530R-AJ	3	14	●												19.6	11.2	5.6	1
XVCT160532R-AJ	3.2	14	●												19.2	11.2	5.6	1
XVCT160540R-AJ	4	13	●												18.5	11.2	5.5	1.2
XVCT160550R-AJ	5	13	●												18.3	11.2	5.4	0.4

When using inserts with corner radius RE ≥ 3.2 mm, standard cutter body has to be modified with "R". "R" = RE - 0.3 mm

● : Line up

STANDARD CUTTING CONDITIONS

ISO	Workpiece material	Hardness HB	Grade	Chip-breaker	Cutting speed Vc (m/min)	Feed per tooth fz (mm/t)
N	Aluminium alloy	60	TH10	AJ	300 - 5000	0.15 - 0.35
		100	TH10	AJ	200 - 2000	0.1 - 0.25
	Cast aluminium alloy Si ≤ 12%	75	TH10	AJ	200 - 2000	0.15 - 0.3
		90	TH10	AJ	200 - 1500	0.1 - 0.25
	Cast aluminium alloy Si > 12%	130	TH10	AJ	200 - 1000	0.07 - 0.15
	Copper alloys Pb > 1%	110	TH10	AJ	200 - 800	0.07 - 0.15
	Copper alloys	90	TH10	AJ	300 - 1000	0.1 - 0.15
		100	TH10	AJ	300 - 800	0.1 - 0.15
	Duroplastics, fiber plastics	-	TH10	AJ	100 - 500	0.1 - 0.15
	Hard rubber	-	TH10	AJ	100 - 300	0.1 - 0.15

Safety guidelines

1. Use only the original inserts, cutters and spare parts.
2. Insert pocket must be cleaned before clamping the insert.
3. Clamp torque of screw should be 4.5 N-m.
4. For safety reasons, use a new screw when changing the insert.
5. Maximum RPM values are determined based on the burst test. Using RPM beyond maximum values may cause insert breakage, machine damage or personal injury.
6. XVCT insert has sharp cutting edges. Always wear gloves for protection from injury when handling.

Grade A
 Insert B
 Ext. Toolholder C
 Int. Toolholder D
 Threading E
 Grooving F
 Miniature tool G
 Milling cutter H
 Endmill I
 Drilling tool J
 Tooling System K
 User's Guide L
 Index M

APPLICATION RANGE

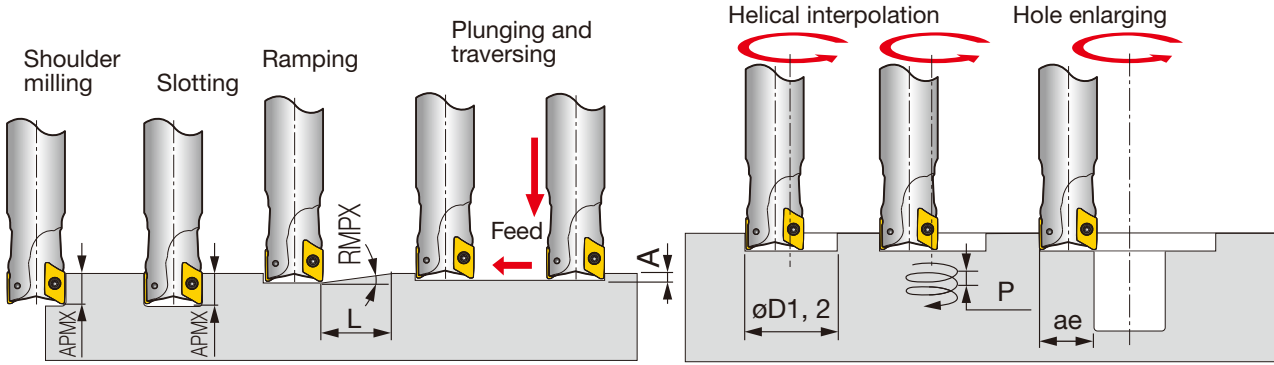

Designation	Tool DC	Corner radius RE	Max. depth of cut APMX	Max. ramping angle RMPX	Min. length L	Max. plunging depth A	Straight ramp down		Helical ramp down		Hole enlarging Max. width
							Min. machining $\phi D1$	Min. pitch/rev P	Min. machining $\phi D2$	Max. pitch/rev P	
EPV16R025...	25	0.4, 0.8	16	22	40	4.2	29.1	4.4	49	13.6	22.5
EPV16R025...	25	1.2	15.5	22	40	4.2	29.1	4.4	49	13.6	22.5
EPV16R025...	25	1.6	15	22	38	3.7	29.1	4.4	49	13.2	22.5
EPV16R025...	25	2	14.5	22	38	3.7	29.1	4.4	49	13.2	22.5
EPV16R025...	25	3, 3.2	14	21	38	2.5	29.1	4.2	49	12.3	22.5
EPV16R025...	25	4, 5	13	18.5	40	2.3	29.1	3.7	49	12.3	22.5
EPV16R032...	32	0.4, 0.8	16	16.5	54	4	43.1	8.8	63	13.6	28.8
EPV16R032...	32	1.2	15.5	16.5	54	4	43.1	8.8	63	13.6	28.8
EPV16R032...	32	1.6	15	16	54	3.5	43.1	8.5	63	13.2	28.8
EPV16R032...	32	2	14.5	16	54	3.5	43.1	8.5	63	13.2	28.8
EPV16R032...	32	3, 3.2	14	15	54	3	43.1	7.9	63	12.3	28.8
EPV16R032...	32	4, 5	13	13.5	56	2.5	43.1	7.1	63	12.3	28.8
T/EPV16R040...	40	0.4, 0.8	16	11.5	79	4	59.1	10.4	79	13.6	36
T/EPV16R040...	40	1.2	15.5	11.5	79	4	59.1	10.4	79	13.6	36
T/EPV16R040...	40	1.6	15	11	80	3.5	59.1	9.9	79	13.2	36
T/EPV16R040...	40	2	14.5	11	80	3.5	59.1	9.9	79	13.2	36
T/EPV16R040...	40	3, 3.2	14	10	82	3	59.1	9	79	12.3	36
T/EPV16R040...	40	4, 5	13	8.5	90	2.5	59.1	7.6	79	12.3	36
TPV16R050...	50	0.4, 0.8	16	9.5	96	4	79.1	13	99	13.6	45
TPV16R050...	50	1.2	15.5	9.5	96	4	79.1	13	99	13.6	45
TPV16R050...	50	1.6	15	9	98	3.5	79.1	12.3	99	13.2	45
TPV16R050...	50	2	14.5	9	98	3.5	79.1	12.3	99	13.2	45
TPV16R050...	50	3.0, 3.2	14	8	103	3	79.1	10.9	99	12.3	45
TPV16R050...	50	4, 5	13	7	110	2.5	79.1	9.5	99	12.3	45
TPV16R063...	63	0.4, 0.8	16	7	130	4	105.1	13.6	125	13.6	56.7
TPV16R063...	63	1.2	15.5	7	130	4	105.1	13.6	125	13.6	56.7
TPV16R063...	63	1.6	15	6.5	136	3.5	105.1	12.8	125	13.2	56.7
TPV16R063...	63	2	14.5	6.5	136	3.5	105.1	12.8	125	13.2	56.7
TPV16R063...	63	3.0, 3.2	14	6	136	3	105.1	11.8	125	12.3	56.7
TPV16R063...	63	4, 5	13	5.5	140	2.5	105.1	10.8	125	12.3	56.7
TPV16R080...	80	0.4, 0.8	16	5	183	4	139.1	13.6	159	13.6	72
TPV16R080...	80	1.2	15.5	5	183	4	139.1	13.6	159	13.6	72
TPV16R080...	80	1.6	15	4.5	197	3.5	139.1	12.4	159	13.2	72
TPV16R080...	80	2	14.5	4.5	197	3.5	139.1	12.4	159	13.2	72
TPV16R080...	80	3, 3.2	14	4	207	3	139.1	11	159	12.3	72
TPV16R080...	80	4, 5	13	3.5	221	2.5	139.1	9.6	159	12.3	72
TPV16R100...	100	0.4, 0.8	16	3.5	262	4	179.1	12.9	199	13.6	90
TPV16R100...	100	1.2	15.5	3.5	262	4	179.1	12.9	199	13.6	90
TPV16R100...	100	1.6	15	3	296	3.5	179.1	11.1	199	13.2	90
TPV16R100...	100	2	14.5	3	296	3.5	179.1	11.1	199	13.2	90
TPV16R100...	100	3, 3.2	14	2.5	332	3	179.1	9.2	199	12.3	90
TPV16R100...	100	4, 5	13	2.5	309	2.5	179.1	9.2	199	11.6	90
TPV16R125...	125	0.4, 0.8	16	2.5	367	4	229.1	12.1	249	13.6	112.5
TPV16R125...	125	1.2	15.5	2.5	367	4	229.1	12.1	249	13.6	112.5
TPV16R125...	125	1.6	15	2	444	3.5	229.1	9.7	249	13.2	112.5
TPV16R125...	125	2	14.5	2	444	3.5	229.1	9.7	249	13.2	112.5
TPV16R125...	125	3, 3.2	14	1.5	554	3	229.1	7.3	249	8.7	112.5
TPV16R125...	125	4, 5	13	1.5	516	2.5	229.1	7.3	249	8.7	112.5

Square shoulder endmill, shank type, with screw clamp system

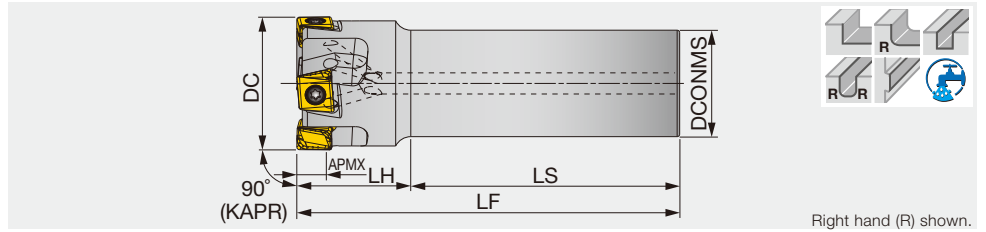

Designation	APMX	DC	CICT	DCONMS	LS	LH	LF	WT(kg)	Air hole	Insert
EPM11R032M32.0-03	9.7	32	3	32	80	35	115	0.6	With	LMMU1107...
EPM11R040M32.0-04	9.7	40	4	32	80	35	115	0.7	With	LMMU1107...
EPM11R050M32.0-04	9.7	50	4	32	80	40	120	0.9	With	LMMU1107...
EPM11R063M32.0-06	9.7	63	6	32	80	40	120	1.2	With	LMMU1107...
EPM11R080M32.0-07	9.7	80	7	32	80	40	120	1.6	With	LMMU1107...

TPM11,16

Square shoulder mill, with screw clamp system

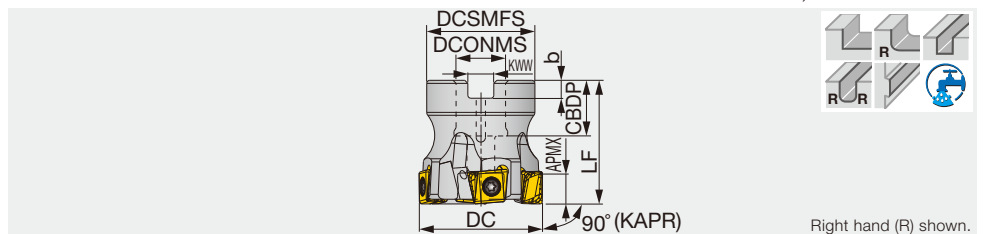

Designation	APMX	DC	CICT	DCSMFS	LF	DCONMS	CBDP	KWW	b	WT(kg)	Air hole	Insert
TPM11R050M22.0-05	9.7	50	5	41	40	22	20	10	6	0.3	With	LMMU1107...
TPM11R050M22.0E05	9.7	50	5	41	40	22	20	10.4	6.3	0.3	With	LMMU1107...
TPM11R063M22.0-06	9.7	63	6	41	40	22	20	10	6	0.5	With	LMMU1107...
TPM11R063M22.0E06	9.7	63	6	41	40	22	20	10.4	6.3	0.5	With	LMMU1107...
TPM11R080M25.4-07	9.7	80	7	46	50	25.4	26	9.5	6	0.9	With	LMMU1107...
TPM11R080M25.4-09	9.7	80	9	46	50	25.4	26	9.5	6	1	With	LMMU1107...
TPM11R080M27.0E07	9.7	80	7	50	50	27	22	12.4	7	1	With	LMMU1107...
TPM11R080M27.0E09	9.7	80	9	50	50	27	22	12.4	7	1	With	LMMU1107...
TPM16R080M25.4-05	15.1	80	5	46	50	25.4	26	9.5	6	1	With	LMMU1609...
TPM16R080M27.0E05	15.1	80	5	50	50	27	22	12.4	7	1	With	LMMU1609...
TPM11R100M31.7-08	9.7	100	8	60	50	31.75	32	12.7	8	1.4	With	LMMU1107...
TPM11R100M31.7-11	9.7	100	11	60	50	31.75	32	12.7	8	1.5	With	LMMU1107...
TPM11R100M32.0E08	9.7	100	8	60	50	32	28.5	14.4	8	1.4	With	LMMU1107...
TPM11R100M32.0E11	9.7	100	11	60	50	32	28.5	14.4	8	1.5	With	LMMU1107...
TPM16R100M31.7-06	15.1	100	6	60	50	31.75	32	12.7	8	1.6	With	LMMU1609...
TPM16R100M32.0E06	15.1	100	6	60	50	32	28.5	14.4	8	1.5	With	LMMU1609...
TPM16R125M38.1-07	15.1	125	7	80	63	38.1	38	15.9	10	3	With	LMMU1609...
TPM16R125M40.0E07	15.1	125	7	71	63	40	32	16.4	9	2.7	With	LMMU1609...

SPARE PARTS

Designation	Clamping screw	Wrench	Shell locking bolt 1	Shell locking bolt 2	Torx bit
EPM11...	SM35-114-H0	T-15DF	-	-	-
TPM11R050, 063...	SM35-114-H0	T-15DF	-	CM10X30H	-
TPM11R080M...	SM35-114-H0	T-15DF	-	CM12X30H	-
TPM11R100M...	SM35-114-H0	T-15DF	TMBA-M16H	-	-
TPM16R080M25.4-05, TPM16R080M27.0E05	CSTB-5L159	-	-	CM12X30H	BT20S
TPM16R100M31.7-06, TPM16R100M32.0E06	CSTB-5L159	-	TMBA-M16H	-	BT20S
TPM16R125M38.1-07, TPM16R125M40.0E07	CSTB-5L159	-	TMBA-M20H	-	BT20S

Recommended clamping torque : SM35-114-H0 = 3.5 N·m, CSTB-5L159 = 5 N·m

Reference pages: Inserts → **H165**, Standard cutting conditions → **H166**





TECMILL

TPM16-SA



Square shoulder mill (shell mill)

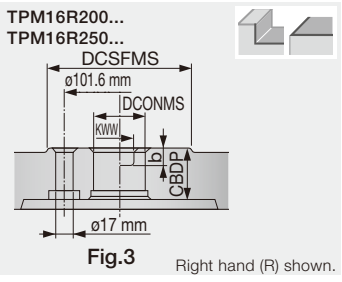
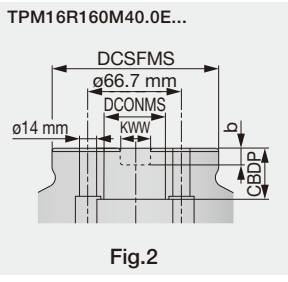
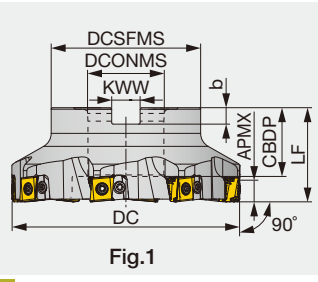

GAMP = +4.9° ~ +5°, GAMF = -17.5°

Right hand (R) shown.

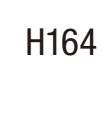
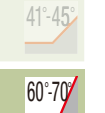

Designation	APMX	DC	CICT	DCSFMS	LF	DCONMS	CBDP	KWW	b	WT(kg)	Air hole	Insert	Fig.
TPM16R160M50.8-08SA	15.1	160	8	100	63	50.8	46	19	11	4.6	Without	LMMU1609...	1
TPM16R160M40.0E08SA	15.1	160	8	100	63	40	29	16.4	9	4.37	Without	LMMU1609...	2
TPM16R200M47.6-10SA	15.1	200	10	130	63	47.625	38	25.4	14	6.4	Without	LMMU1609...	3
TPM16R200M60.0E10SA	15.1	200	10	130	63	60	38	25.7	14	5.9	Without	LMMU1609...	3
TPM16R250M47.6-12SA	15.1	250	12	130	63	47.625	38	25.4	14	13.2	Without	LMMU1609...	3
TPM16R250M60.0E12SA	15.1	250	12	130	63	60	38	25.7	14	12.7	Without	LMMU1609...	3

TGM16-SA

60° face mill (shell mill)

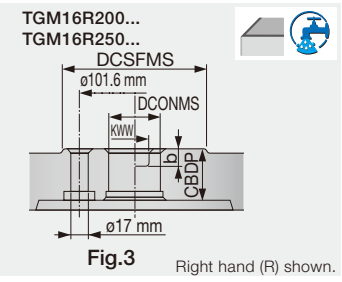
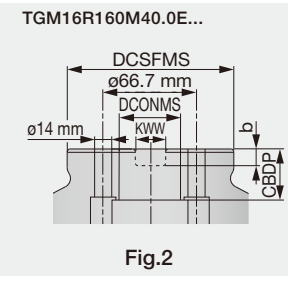
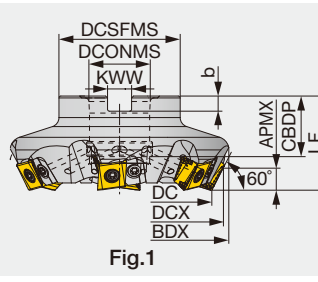

GAMP = +11.4° ~ +11.5°, GAMF = -13.5°

Right hand (R) shown.

Designation	APMX*	DC*	DCX*	BDX	CICT	DCSFMS	LF*	DCONMS	CBDP	KWW	b	WT(kg)	Air hole	Insert	Fig.
TGM16R100M31.7-06SA	12.4	100	115.3	115.5	6	64	50	31.75	32	12.7	8	1.8	With	LMMU1609...	1
TGM16R100M32.0E06SA	12.4	100	115.3	115.5	6	66	50	32	28.5	14.4	8	1.8	With	LMMU1609...	1
TGM16R125M38.1-07SA	12.4	125	140.3	140.6	7	80	63	38.1	38	15.9	10	3.5	With	LMMU1609...	1
TGM16R125M40.0E07SA	12.4	125	140.3	140.6	7	85	63	40	32	16.4	9	3.4	With	LMMU1609...	1
TGM16R160M50.8-08SA	12.4	160	175.3	174.9	8	100	63	50.8	46	19	11	5.8	Without	LMMU1609...	1
TGM16R160M40.0E08SA	12.4	160	175.3	174.9	8	100	63	40	29	16.4	9	5.5	Without	LMMU1609...	2
TGM16R200M47.6-10SA	12.4	200	215.3	217.2	10	130	63	47.625	38	25.4	14	7.7	Without	LMMU1609...	3
TGM16R200M60.0E10SA	12.4	200	215.3	217.2	10	130	63	60	38	25.7	14	7.2	Without	LMMU1609...	3
TGM16R250M47.6-12SA	12.4	250	265.3	267	12	130	63	47.625	38	25.4	14	14.8	Without	LMMU1609...	3
TGM16R250M60.0E12SA	12.4	250	265.3	267	12	130	63	60	38	25.7	14	14.4	Without	LMMU1609...	3

*The dimensions are true with 1.6 mm-radius inserts

SPARE PARTS



Designation	Clamping screw	Shim	Shim screw	Grip	Torx bit	Shell locking bolt
TPM16... TGM16R160 - 250...	CSTB-5L159	SA-LMMU1609R	CSTB-5L159	H-TB	BT20S	-
TGM16R100...	CSTB-5L159	SA-LMMU1609R	CSTB-5L159	H-TB	BT20S	TMBA-M16H
TGM16R125...	CSTB-5L159	SA-LMMU1609R	CSTB-5L159	H-TB	BT20S	TMBA-M20H

Recommended clamping torque : 5 N-m

Reference pages: Standard cutting conditions → **H166**

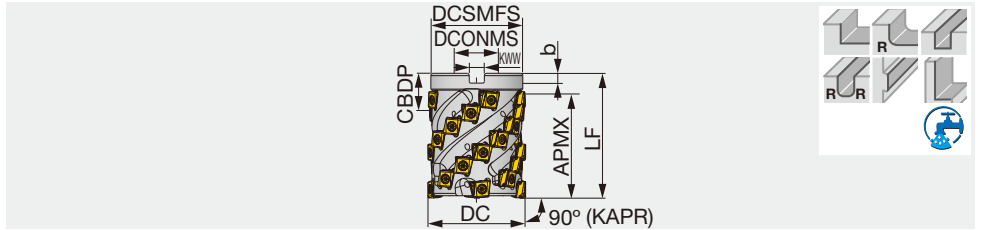

Designation	APMX	DC	ZEFP	CICT	DCSMFS	LF	DCONMS	CBDP	KWW	b	WT(kg)	Air hole	Insert
TLM11R050M22.0E03	58.5	50	3	21	47	70	22	20	10.4	6.3	0.8	With	LMMU1107...
TLM11R063M25.4-04	66.9	63	4	32	59	80	25.4	26	9.5	6	1.4	With	LMMU1107...
TLM11R063M27.0E04	66.9	63	4	32	59	80	27	22	12.4	7	1.4	With	LMMU1107...

Note: Coolant needs to be supplied from the end of the arbor inlay. Coolant cannot be supplied from the set bolt.

SPARE PARTS

Designation	Clamping screw	Grip	Shell locking bolt
TLM11R050M22.0E03	SM35-114-H0	T-15DF	SD06-A3
TLM11R063M25.4-04, TLM11R063M27.0E04	SM35-114-H0	T-15DF	SD08-98

Recommended clamping torque : 3.5 N-m

INSERT

LMMU11/16-MJ

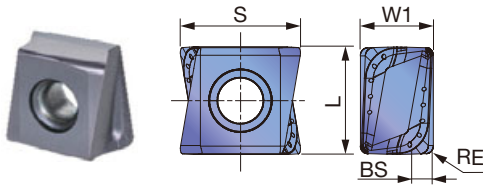

	P	M	K	N	S	H
Steel	★ ☆					☆
Stainless	★				☆	
Cast iron			★		☆	
Non-ferrous						
Superalloys	☆	★	☆			
Hard materials		★				

★ : First choice
☆ : Second choice

Designation	RE	APMX	Coated						S	L	W1	BS
			AH3135	AH725	AH120	AH140	T1215	T3225				
LMMU110708PNER-MJ	0.8	9.7	●	●	●	●	●	●	11.7	10.5	7.1	2
LMMU110716PNER-MJ	1.6	9.7	●	●	●	●	●	●	11.5	10.5	7.1	1.2
LMMU110724PNER-MJ	2.4	9.7		●	●	●			11.3	10.5	7.1	0.4
LMMU110732PNER-MJ	3.2	9.7		●	●	●			11.1	10.5	7.1	-
LMMU160908PNER-MJ	0.8	15.1	●	●	●	●	●	●	17.3	16	9.5	2.4
LMMU160916PNER-MJ	1.6	15.1	●	●	●	●			17.1	16	9.5	1.6
LMMU160924PNER-MJ	2.4	15.1		●	●	●			16.9	16	9.5	0.8
LMMU160932PNER-MJ	3.2	15.1		●	●	●			16.8	16	9.5	-

● : Line up



STANDARD CUTTING CONDITIONS

Bore, shank type

ISO	Workpiece materials	Hardness	Priority	Grades	Cutting speed Vc (m/min)	Feed per tooth: fz (mm/t)		
						TPM16...	TGM16...	
P	Low carbon steel S15C, SS400, etc. C15E4, E275A, etc.	- 200HB	First choice	AH3135	80 - 250	0.08 - 0.3	0.1 - 0.4	
			Wear resistance	T3225	100 - 350	0.08 - 0.3	0.1 - 0.4	
	Carbon steel and alloy steel S55C, SCM440, etc. C55, 42CrMo4, etc.	- 300HB	First choice	AH3135	80 - 250	0.08 - 0.3	0.1 - 0.4	
			Wear resistance	T3225	100 - 350	0.08 - 0.3	0.1 - 0.4	
M	Prehardened steel NAK80, PX5, etc.	30 - 40HRC	First choice	AH3135	80 - 250	0.05 - 0.25	0.08 - 0.3	
			Wear resistance	T3225	100 - 250	0.05 - 0.25	0.08 - 0.3	
K	Stainless steel SUS304, etc. X5CrNi18-9, etc.	- 200HB	First choice	AH3135	80 - 200	0.05 - 0.25	0.08 - 0.3	
			Wear resistance	T3225	100 - 250	0.05 - 0.25	0.08 - 0.3	
	Grey cast iron FC250, etc. 250, etc.	150 - 250HB	First choice	T1215	100 - 350	0.08 - 0.3	0.1 - 0.4	
			Fracture resistance	AH120	80 - 250	0.08 - 0.3	0.1 - 0.4	
S	Ductile cast iron FCD400, FCD600, etc. 400-15S, 600-3, etc.	150 - 250HB	First choice	AH120	80 - 250	0.05 - 0.3	0.1 - 0.4	
			Wear resistance	T1215	100 - 350	0.08 - 0.3	0.1 - 0.4	
H	Titanium alloys Ti-6Al-4V, etc.	- 45HRC	First choice	AH3135	30 - 60	0.05 - 0.2	0.08 - 0.25	
			Wear resistance	AH725	30 - 60	0.05 - 0.2	0.08 - 0.25	
H	Superalloys Inconel718, etc.	- 45HRC	First choice	AH725	20 - 50	0.04 - 0.14	0.05 - 0.18	
			Wear resistance	AH725	20 - 50	0.04 - 0.14	0.05 - 0.18	
	Hardened steel	SKD61, etc. X40CrMoV5-1, etc.	40 - 55HRC	First choice	AH3135	50 - 130	0.03 - 0.17	0.05 - 0.2
				Wear resistance	AH725	50 - 130	0.03 - 0.17	0.05 - 0.2
H	SKD11, etc. X153CrMoV12, etc.	55 - 60HRC	First choice	AH725	40 - 70	0.03 - 0.1	0.04 - 0.12	

Roughing type

ISO	Workpiece materials	Hardness	Priority	Grades	Cutting speed Vc (m/min)	Feed per tooth fz (mm/t)	
P	Low carbon steel S15C, SS400, etc. C15E4, E275A, etc.	- 200 HB	First choice	AH3135	100 - 250	0.1 - 0.25	
			Wear resistance	T3225	150 - 350	0.1 - 0.2	
	Carbon steel and alloy steel S55C, SCM440, etc. C55, 42CrMo4, etc.	- 300 HB	First choice	AH3135	100 - 200	0.1 - 0.2	
			Wear resistance	T3225	150 - 300	0.1 - 0.2	
M	Prehardend steel NAK80, PX5, etc.	30 - 40 HRC	First choice	AH3135	100 - 200	0.1 - 0.2	
			Wear resistance	T3225	120 - 300	0.1 - 0.2	
K	Stainless steel SUS304, etc. X5CrNi18-9, etc.	- 200 HB	First choice	AH3135	90 - 150	0.1 - 0.25	
			Wear resistance	T3225	100 - 250	0.1 - 0.25	
K	Grey cast iron FC250, etc. 250, etc.	150 - 250 HB	First choice	AH120	100 - 250	0.1 - 0.25	
			Wear resistance	T1215	120 - 350	0.1 - 0.25	
	Ductile cast iron FCD400, FCD600, etc. 400-15S, 600-3, etc.	150 - 250 HB	First choice	AH120	100 - 200	0.1 - 0.25	
			Wear resistance	T1215	120 - 350	0.1 - 0.25	
S	Titanium alloys Ti-6Al-4V, etc.	- 45HRC	First choice	AH725	20 - 50	0.06 - 0.15	
			Wear resistance	AH725	20 - 40	0.06 - 0.1	
H	Superalloys Inconel718, etc.	- 45HRC	First choice	AH725	20 - 40	0.06 - 0.1	
			Wear resistance	AH725	20 - 40	0.06 - 0.1	
H	Hardened steel	SKD61, etc. X40CrMoV5-1, etc.	40 - 50 HRC	First choice	AH725	30 - 60	0.08 - 0.15
				Wear resistance	AH725	30 - 60	0.08 - 0.15
H	SKD11, etc. X153CrMoV12, etc.	50 - 60 HRC	First choice	AH725	25 - 55	0.06 - 0.1	

Square shoulder endmill, shank type, with screw clamp system

GAMP = +11.5°, GAMF = -13° ~ -10.5°

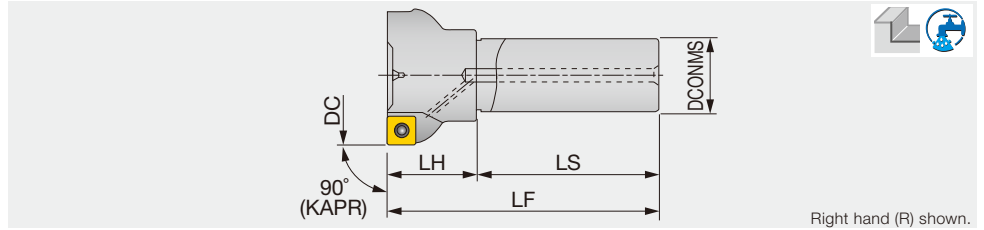

Designation	APMX	DC	CICT	DCONMS	LS	LH	LF	WT(kg)	Air hole	Insert
EPW13R032M32.0-02	10	32	2	32	80	35	115	0.6	With	SW*T1304...
EPW13R040M32.0-03	10	40	3	32	80	35	115	0.7	With	SW*T1304...
EPW13R050M32.0-03	10	50	3	32	80	40	120	0.9	With	SW*T1304...
EPW13R050M32.0-04	10	50	4	32	80	40	120	0.9	With	SW*T1304...
EPW13R063M32.0-04	10	63	4	32	80	40	120	1	With	SW*T1304...
EPW13R063M32.0-05	10	63	5	32	80	40	120	1	With	SW*T1304...
EPW13R080M32.0-04	10	80	4	32	80	40	120	1.3	With	SW*T1304...
EPW13R080M32.0-06	10	80	6	32	80	40	120	0.8	With	SW*T1304...

SPARE PARTS

Designation	Clamping screw	Lubricant	Shim screw	Shim	Wrench	Wrench
EPW13R032, 040...	CSPB-3.5	M-1000	-	-	IP-15D	-
EPW13R050 - 080...	CSPB-3.5	M-1000	DTS5-3.5SS	FSSP1102	IP-15D	P-3.5

Recommended clamping torque : 3.5 N-m





TUNG MILL

TPW13

Square shoulder mill, with screw clamp system

GAMP = +11.5°, GAMF = -13° ~ -10.5°

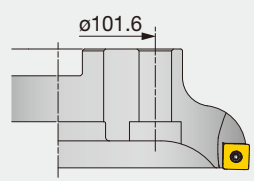
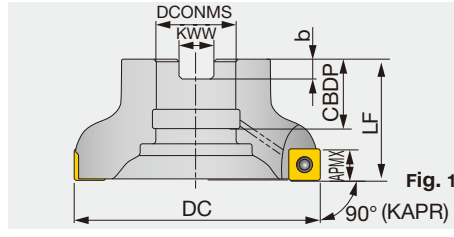

Right hand (R) shown.

Designation	APMX	DC	CICT	LF	DCONMS	CBDDP	KWW	b	WT(kg)	Air hole	Insert	Fig.
TPW13R050M22.0-03	10	50	3	40	22	20	10	6	0.3	With	SW*T1304...	1
TPW13R050M22.0-04	10	50	4	40	22	20	10	6	0.3	With	SW*T1304...	1
TPW13R050M22.0E04	10	50	4	40	22	20	10.4	6.3	0.3	With	SW*T1304...	1
TPW13R050M22.0E05	10	50	5	40	22	20	10.4	6.3	0.3	With	SW*T1304...	1
TPW13R063M22.0-04	10	63	4	40	22	20	10	6	0.5	With	SW*T1304...	1
TPW13R063M22.0-05	10	63	5	40	22	20	10	6	0.5	With	SW*T1304...	1
TPW13R063M22.0E05	10	63	5	40	22	20	10.4	6.3	0.4	With	SW*T1304...	1
TPW13R063M22.0E06	10	63	6	40	22	20	10.4	6.3	0.4	With	SW*T1304...	1
TPW13R080M25.4-04	10	80	4	50	25.4	26	9.5	6	0.8	With	SW*T1304...	1
TPW13R080M25.4-06	10	80	6	50	25.4	26	9.5	6	0.8	With	SW*T1304...	1
TPW13R080M27.0E06	10	80	6	50	27	22	12.4	7	0.8	With	SW*T1304...	1
TPW13R080M27.0E08	10	80	8	50	27	22	12.4	7	0.8	With	SW*T1304...	1
TPW13R100M31.7-05	10	100	5	50	31.75	38	12.7	8	1.2	With	SW*T1304...	1
TPW13R100M31.7-07	10	100	7	50	31.75	38	12.7	8	1.2	With	SW*T1304...	1
TPW13R100M32.0E07	10	100	7	50	32	28.5	14.4	8	1.2	With	SW*T1304...	1
TPW13R100M32.0E10	10	100	10	50	32	28.5	14.4	8	1.2	With	SW*T1304...	1
TPW13R125M38.1-06	10	125	6	63	38.1	38	15.9	10	2.4	With	SW*T1304...	1
TPW13R125M38.1-08	10	125	8	63	38.1	38	15.9	10	2.4	With	SW*T1304...	1
TPW13R125M40.0E08	10	125	8	63	40	32	16.4	9	2.4	With	SW*T1304...	1
TPW13R125M40.0E12	10	125	12	63	40	32	16.4	9	2.5	With	SW*T1304...	1
TPW13R160M50.8-08	10	160	8	63	50.8	38	19	11	4	Without	SW*T1304...	1
TPW13R160M50.8-12	10	160	12	63	50.8	38	19	11	4	Without	SW*T1304...	1
TPW13R200M47.6-10	10	200	10	63	47.625	38	25.4	14	7.4	Without	SW*T1304...	2

SPARE PARTS



Designation	Clamping screw	Lubricant	Shim screw	Shell locking bolt 1	Shell locking bolt 2	Shim	Wrench	Wrench
TPW13R050, 063...	CSPB-3.5	M-1000	DTS5-3.5SS	-	CM10X30H	FSSP1102	IP-15D	P-3.5
TPW13R080M...	CSPB-3.5	M-1000	DTS5-3.5SS	-	CM12X30H	FSSP1102	IP-15D	P-3.5
TPW13R100M...	CSPB-3.5	M-1000	DTS5-3.5SS	TMBA-M16H	-	FSSP1102	IP-15D	P-3.5
TPW13R125M...	CSPB-3.5	M-1000	DTS5-3.5SS	TMBA-M20H	-	FSSP1102	IP-15D	P-3.5
TPW13R160, 200...	CSPB-3.5	M-1000	DTS5-3.5SS	-	-	FSSP1102	IP-15D	P-3.5

Recommended clamping torque : 3.5 N·m

INSERT

SWG T1304-MJ

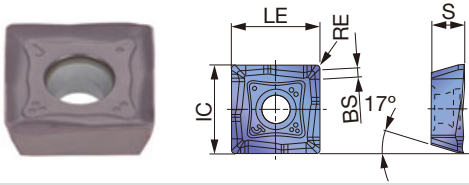

SWMT1304-MJ

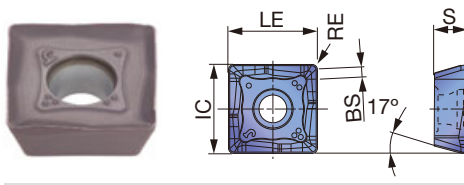

SWMT1304-ML

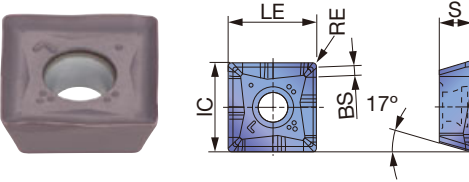

SWMT1304-MS

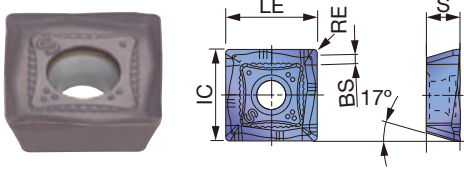

SWG T1304-AJ

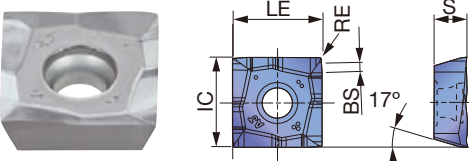

P	Steel	☆						☆	☆	★									
M	Stainless		★	☆	★				☆										
K	Cast iron	★				☆	★												
N	Non-ferrous									★							★		
S	Superalloys	★	☆																
H	Hard materials																		

★ : First choice
☆ : Second choice

Designation	RE	APMX	Coated							Cermet	Uncoated	LE	IC	S	BS			
			AH120	AH130	AH140	AH3135	T1115	T1215	T3130	T3225	DS1100					NS740	KS05F	
SWG T1304PDPR-MJ	0.8	10	●								●				13.6	13.6	5	1.4
SWMT1304PDPR-MJ	0.8	10	●	●	●	●	●	●	●	●	●				13.6	13.6	5	1.4
SWMT1304PDER-ML	0.8	10	●			●									13.6	13.6	5	1.4
SWMT1304PDPR-MS	0.8	10		●	●										13.6	13.6	5	1.4
SWG T1304PDFR-AJ	0	10								●		●			13.6	13.6	5	1.6

● : Line up

STANDARD CUTTING CONDITIONS

Please scan below.

e-catalog



EPW13

e-catalog



TPW13

Face mill arbors with center through-coolant hole

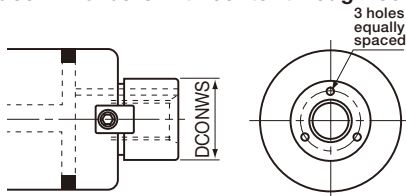

Cutter diameter DC (mm)	50/63	80	100	125	160
Nominal diameter DCONWS (mm)	22	25.4	31.75	38.1	50.8
Arbor type	FMH22	FMH25.4	FMH31.75	FMH38.1	FMH50.8

Notes on arbors: when using TAW13 or TPW13 type, use through center air.

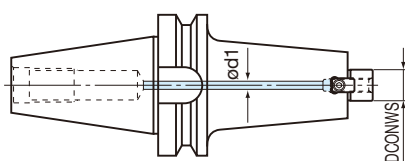

Nominal diameter DCONWS (mm)	16	22	25.4	31.75	38.1	50.8
Applicable arbor types	SMA SM1	FMC SM1	FMA FMC	FMA SMB	FMA	FMA
Through hole diameter ød1 (mm)	4 ~ 6	5 ~ 8	6 ~ 9	10 ~ 13	10 ~ 15	10 ~ 15

When using the TAW13 or TPW13 type with through center air (coolant or mist), the correct arbor must be used with through center air supplying.

Cautionary notes in use

- In slotting or pocketing, when chips are likely to remain in the cutting zone, internal air supplying or air blow is recommended to prevent chip recutting.
- Use of inserts other than those specified, can result in poor cutting and cause damage to the cutter body. Therefore, specified inserts from the Tungaloy catalogue must be used.
- Before changing or indexing the inserts, remove chips or other foreign matter from the insert, insert pocket and cutter body by using an air blast or cloth.
- The inserts should be clamped by using the wrench supplied with the TAC Mill.
- After a long period of use, the clamping screws and wrench may become deformed or damaged. These elements must be replaced as soon as possible.



TUNGSHRED

EPTC16

Square shoulder endmill, shank type, with screw clamp system

GAMP = +5.5°~ +6.5°, GAMF = -11.5°~ -11.3°

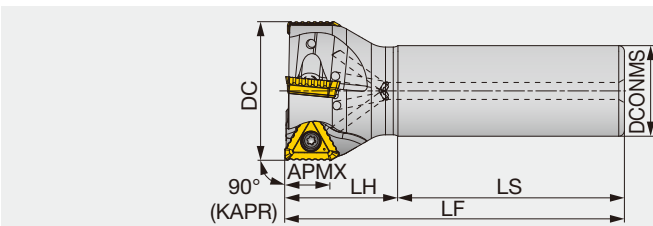

Designation	APMX	DC	CICT	DCONMS	LS	LH	LF	WT(kg)	Air hole	Insert
EPTC16M050C32.0R04	16	50	4	32	80	40	120	0.8	With	TC*T16...
EPTC16M050C42.0R02L	16	50	2	42	310	50	360	3.8	With	TC*T16...



TPTC16

Square shoulder mill, with screw clamp system, for shred inserts

GAMP = +5.5°~ +6.5°, GAMF = -11.5°~ -11.3°

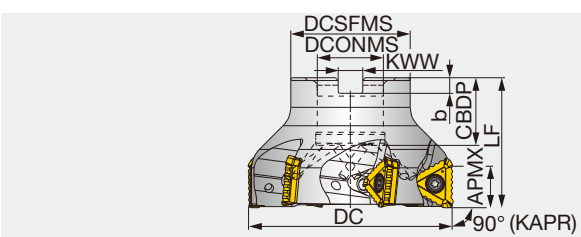

Designation	APMX	DC	CICT	DCSFMS	LF	DCONMS	CBBDP	KWW	b	WT(kg)	Air hole	Insert
TPTC16M050B22.0R04	16	50	4	41	40	22	20	10.4	6.3	0.29	With	TC*T16...
TPTC16M063B22.0R05	16	63	5	41	40	22	20	10.4	6.3	0.44	With	TC*T16...
TPTC16J080B25.4R06	16	80	6	46	50	25.4	26	9.5	6	0.88	With	TC*T16...
TPTC16M080B27.0R06	16	80	6	50	50	27	22	12.4	7	0.9	With	TC*T16...
TPTC16J100B31.7R07	16	100	7	60	50	31.75	32	12.7	8	1.38	With	TC*T16...
TPTC16M100B32.0R07	16	100	7	60	50	32	28.5	14.4	8	1.35	With	TC*T16...

Approach angle



LPTC16

Square shoulder mill for roughing, with screw clamp system, for shred inserts

GAMP = +5.5°~ +6.5°, GAMF = -11.5°~ -11.3°



Others

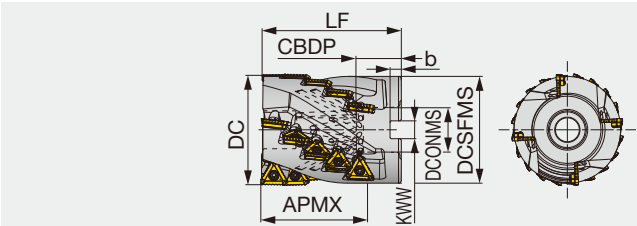

Designation	APMX	DC	ZEFP	CICT	DCSFMS	LF	DCONMS	CBBDP	KWW	b	WT(kg)	Air hole	Insert
LPTC16J063B25.4L061R03	61	63	3	12	59	85	25.4	26	9.5	6	1.25	With	TC*T16...
LPTC16M063B27.0L061R03	61	63	3	12	59	85	27	22	12.4	7	1.24	With	TC*T16...
LPTC16J080B31.7L076R04	76	80	4	20	76	100	31.75	32	12.7	8	2.44	With	TC*T16...
LPTC16M080B32.0L076R04	76	80	4	20	76	100	32	25	14.4	8	2.46	With	TC*T16...

Note: Coolant needs to be supplied from the end of the arbor inlay. Coolant cannot be supplied from the set bolt.

SPARE PARTS

Designation	Clamping screw	Grip	Lubricant	Shell locking bolt1	Shell locking bolt2	Shell locking bolt3	Torx bit
EPTC16...	TS 40B100I	H-TB2W	M-1000	-	-	-	BT15S
TPTC16M050B22.0R04	TS 40B100I	H-TB2W	M-1000	-	-	FSHM10-40H	BT15S
TPTC16M063B22.0R05	TS 40B100I	H-TB2W	M-1000	-	-	CM10X30H	BT15S
TPTC16*080B...	TS 40B100I	H-TB2W	M-1000	-	-	CM12X30H	BT15S
TPTC16*100B...	TS 40B100I	H-TB2W	M-1000	-	TMBA-M16H	-	BT15S
LPTC16*063B...	TS 40B100I	H-TB2W	M-1000	CAP-CM12X1.75X50	-	-	BT15S
LPTC16*080B...	TS 40B100I	H-TB2W	M-1000	CM16X75	-	-	BT15S

Recommended clamping torque: 3.5 N·m

INSERT

TCGT-MJ

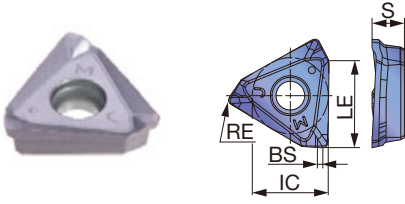

TCMT-NMJ

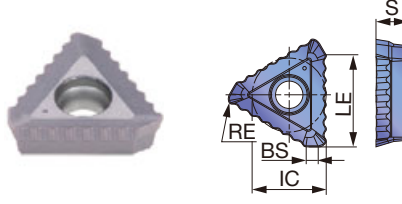

P Steel	☆	★	☆	
M Stainless		★		
K Cast iron	★		☆	
N Non-ferrous				
S Superalloys	★	☆		
H Hard materials				

★ : First choice
☆ : Second choice

Designation	RE	APMX	Coated				LE	IC	S	BS
			AH120	AH3135	T1215	T3225				
TCGT160608PDER-MJ	0.8	16	●	●			16	13.7	5.8	1
TCMT160620PDER-NMJ	2	16	●	●	●	●	16	13.3	5.8	2

● : Line up

STANDARD CUTTING CONDITIONS

ISO	Workpiece materials	Hardness	Priority	Grade	Chip-breaker	Cutting speed Vc (m/min)	Feed per tooth fz (mm/t)
P	Low carbon steel S15C, S20S, etc. C15, C20, etc.	- 300 HB	First choice	AH3135	NMJ*	100 - 250	0.08 - 0.15
			Wear resistance	T3225	NMJ*	100 - 300	0.08 - 0.15
			For finishing	AH3135	MJ	100 - 250	0.08 - 0.20
	Carbon steel and alloy steel S55C, SCM440, etc. C55, 42CrMo4, etc.	- 300 HB	First choice	AH3135	NMJ*	100 - 230	0.08 - 0.15
			Wear resistance	T3225	NMJ*	100 - 280	0.08 - 0.15
			For finishing	AH3135	MJ	100 - 230	0.08 - 0.20
Prehardened steel NAK80, PX5, etc.	30 - 40 HRC	First choice	AH3135	NMJ*	100 - 180	0.08 - 0.15	
		Wear resistance	T3225	NMJ*	100 - 200	0.08 - 0.15	
		For finishing	AH3135	MJ	100 - 180	0.08 - 0.20	
M	Stainless steel SUS304, SUS316, etc. X5CrNi18-9, X5CrNiMo17-12-3, etc.	- 250 HB	First choice	AH3135	NMJ*	90 - 200	0.08 - 0.15
			Wear resistance	T3225	NMJ*	90 - 250	0.08 - 0.15
			For finishing	AH3135	MJ	90 - 200	0.08 - 0.20
K	Grey cast iron FC250, FC300, etc. 250, 300, etc.	150 - 250 HB	First choice	AH120	NMJ*	140 - 250	0.08 - 0.15
			Wear resistance	T1215	NMJ*	150 - 300	0.08 - 0.15
			For finishing	AH120	MJ	140 - 250	0.08 - 0.25
	Ductile cast iron FCD400, FCD600, etc. 400-15S, 600-3, etc.	150 - 250 HB	First choice	AH120	NMJ*	140 - 250	0.08 - 0.15
			Wear resistance	T1215	NMJ*	150 - 300	0.08 - 0.15
			For finishing	AH120	MJ	140 - 250	0.08 - 0.25
S	Titanium alloys Ti-6Al-4V, etc.	-	First choice	AH120	NMJ*	20 - 60	0.08 - 0.15
			For finishing	AH120	MJ	20 - 60	0.08 - 0.18
	Heat-resistant alloys Inconel718, etc.	-	First choice	AH120	NMJ*	20 - 40	0.08 - 0.13
			For finishing	AH120	MJ	20 - 40	0.08 - 0.15

* When using the -NMJ chipbreaker, do not feed higher than 0.15 mm/t.

Grade
Insert
Ext. Toolholder
Int. Toolholder
Threading
Grooving
Miniature tool
Milling cutter
Endmill
Drilling tool
Tooling System
User's Guide
Index



High Feed Milling

Face Milling

Shoulder Milling

Slot Milling

Profile Milling

Chamfering, Counterbore

Finish Face Milling

THE4000RIA

86° face mill for aluminium machining, with wedge clamp system, for positive square inserts

GAMP = 13°, GAMF = +7° ~ +9°

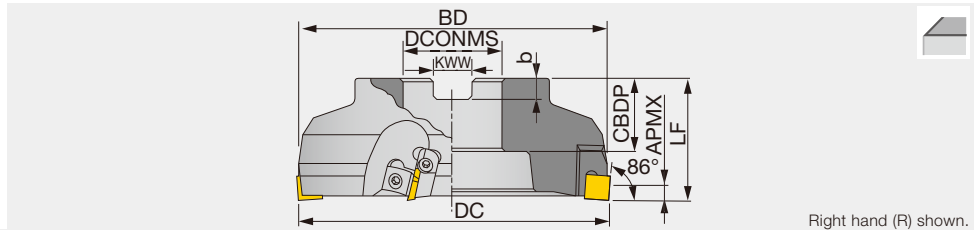

Designation	APMX	DC	CICT	BD	LF	DCONMS	CBDP	KWW	b	WT(kg)	Insert
THE4003RIA	6	80	4	80	50	25.4	26	9.5	6	1.5	S/WE*N42...
THE4004RIA	6	100	5	99	63	31.75	32	12.7	8	2.1	S/WE*N42...
THE4005RIA	6	125	6	124	63	38.1	38	15.9	10	3.2	S/WE*N42...

SPARE PARTS

Designation	① Locator	② Wedge	③ Wedge fixing screw	④ Locator fixing screw	Wrench
THE4003RIA	LE413R	WP440R	FDS-8SS	CM4X0.7X14	TP-4
THE4004RIA	LE413R	WP440R	FDS-8S	CM4X0.7X14	TP-4

Recommended clamping torque : 8 N·m

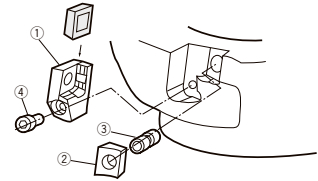

INSERT

SECN42ZFR-DIA

SEEN/SECN 42Z

WECN42ZFR-DIA

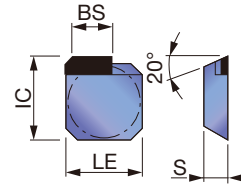
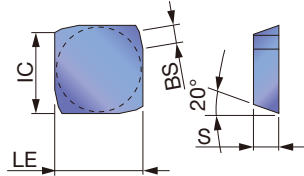
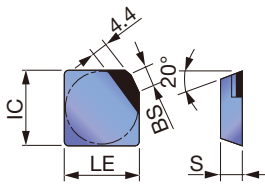

Approach angle

7°-25°

41°-45°

60°-70°

85°-88°

90°

Others

	P	M	K	N	S	H
Steel	●					
Stainless		●				
Cast iron			●			
Non-ferrous				●		
Superalloys					●	
Hard materials						●

★ : First choice
☆ : Second choice

Designation	APMX	Uncoated		PCD		LE	IC	S	BS
		TH10	DX140						
SECN42ZFR-DIA	3.5		●			12.7	12.7	3.18	2.5
SECN42ZFR	6	●				12.7	12.7	3.18	2.5
SEEN42ZFR	6	●				12.7	12.7	3.18	2.5
WECN42ZFR-DIA	0.5		●			12.4	12.93	3.18	6

T-DIA is a diamond-based ultra high pressure sintered body. Available in 1-corner type.

● : Line up

STANDARD CUTTING CONDITIONS

Please scan below.

e-catalog



ESE3000R

Square shoulder endmill, shank type, with wedge clamp system

GAMP = +17°, GAMF = +5°

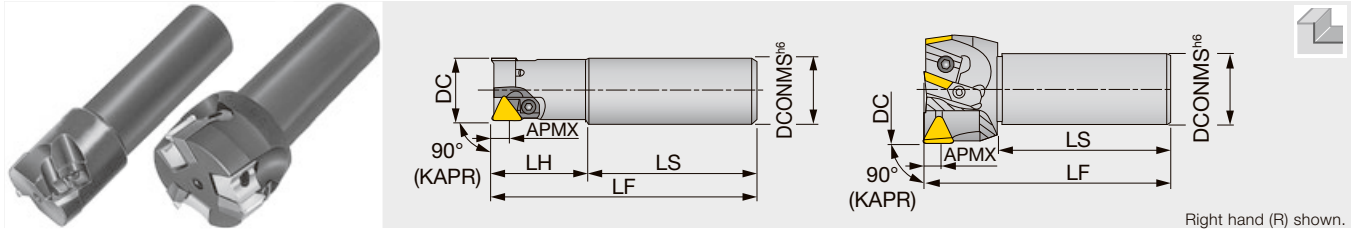

Right hand (R) shown.

Designation	APMX	DC	CICT	DCONMS	LS	LH	LF	Insert
ESE3020R	8	20	1	20	70	30	100	TE*N32/TEKR1603...
ESE3025R	8	25	1	25	80	35	115	TE*N32/TEKR1603...
ESE3030R	8	30	2	32	80	45	125	TE*N32/TEKR1603...
ESE3035R	8	35	2	32	80	45	125	TE*N32/TEKR1603...
ESE3040R	8	40	2	32	80	45	125	TE*N32/TEKR1603...
ESE3050R	8	50	3	32	80	-	115	TE*N32/TEKR1603...
ESE3063R	8	63	4	32	80	-	115	TE*N32/TEKR1603...

Note: The items do not have variable pitch.

TSE3000R

Square shoulder mill, with wedge clamp system

GAMP = +17°, GAMF = +5°

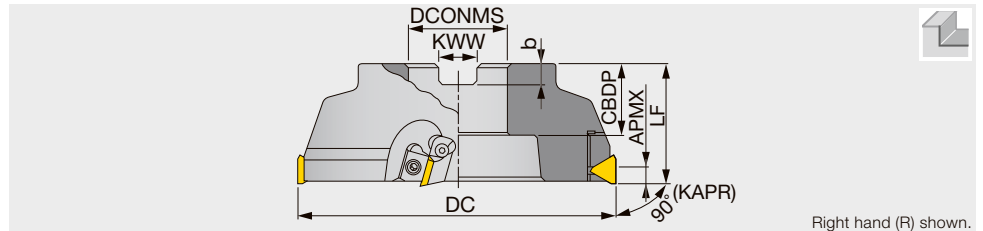

Right hand (R) shown.

Designation	APMX	DC	CICT	LF	DCONMS	CBBDP	KWW	b	WT(kg)	Insert
TSE3050R	8	50	3	40	22	20	10	6	0.3	TE*N32/TEKR1603...
TSE3050R-E	8	50	3	40	22	20	10.4	6.3	0.3	TE*N32/TEKR1603...
TSE3063R	8	63	3	40	22	20	10	6	0.5	TE*N32/TEKR1603...
TSE3063RE	8	63	3	40	22	20	10.4	6.3	0.5	TE*N32/TEKR1603...
TSE3003RIA	8	80	4	50	25.4	26	9.5	6	1	TE*N32/TEKR1603...
TSE3003RIAE	8	80	4	50	27	26	12.4	7	1	TE*N32/TEKR1603...
TSE3004RIA	8	100	6	63	31.75	32	12.7	8	2	TE*N32/TEKR1603...
TSE3004RIAE	8	100	6	63	32	32	14.4	8	2	TE*N32/TEKR1603...
TSE3005RIA	8	125	6	63	38.1	38	15.9	10	3.1	TE*N32/TEKR1603...
TSE3006RIA	8	160	8	63	50.8	38	19	11	5.2	TE*N32/TEKR1603...

TSE3050R/L and TSE3063R/L do not have variable pitch.

SPARE PARTS

Designation	Clamp set	Locator	Wedge fixing screw	Shell locking bolt	Wedge1	Wedge 2	Wrench 1	Wrench 2
TSE3050R..., 63R... ESE3020R - ESE3050R	CSL-4	-	-	-	-	-	-	P-3
TSE300*RIA (E/-E)	-	LE303R	FDS-8S	CM4X0.7X12	WF330R	-	TP-4	-
ESE3063R	-	LE302R	DS-8S	SHCM4-10	-	WP302R	TP-4	-

Recommended clamping torque : 8 N·m

Reference pages: Inserts → [H174](#)



INSERT

TECN/TEEN 32Z

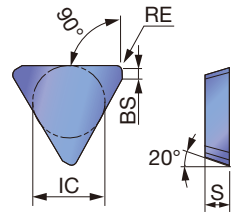

TECN32ZFR-DIA

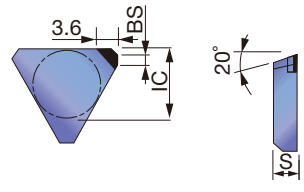

TEKR16-MS

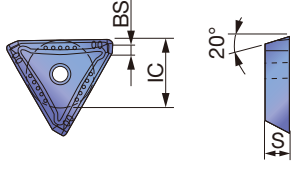

P	Steel	★	★	☆	☆	☆	★	☆	★	☆	☆	☆	☆	☆	☆	☆	☆	☆
M	Stainless	★	☆	☆	☆	☆	★	☆	★	☆	☆	☆	☆	☆	☆	☆	☆	☆
K	Cast iron	★	☆	☆	☆	☆	★	☆	★	☆	☆	☆	☆	☆	☆	☆	☆	☆
N	Non-ferrous	★	☆	☆	☆	☆	★	☆	★	☆	☆	☆	☆	☆	☆	☆	☆	☆
S	Superalloys	★	☆	☆	☆	☆	★	☆	★	☆	☆	☆	☆	☆	☆	☆	☆	☆
H	Hard materials	★	☆	☆	☆	☆	★	☆	★	☆	☆	☆	☆	☆	☆	☆	☆	☆

★ : First choice
☆ : Second choice

Designation	RE	APMX	Coated							Cermet		Uncoated		PCD	IC	S	BS	
			AH120	AH130	AH140	AH330	GH330	T1115	T3130	AH3135	T1215	T3225	NS740	N308				UX30
TECN32ZFR	-	8	★	★	★	★	★	★	★	★	●	●	●	●	●	9.525	3.18	1.37
TECN32ZTR	0.8	8	★	★	★	★	★	★	★	★	●	●	●	●	●	9.525	3.18	1
TEEN32ZFR	-	8	★	★	★	★	★	★	★	★	●	●	●	●	●	9.525	3.18	1.37
TEEN32ZTR	0.8	8	★	★	★	★	★	★	★	★	●	●	●	●	●	9.525	3.18	1
TECN32ZFR-DIA	-	2.5	★	★	★	★	★	★	★	★	●	●	●	●	●	9.525	3.18	1.37
TEKR1603PEPR-MS	-	8	★	★	★	★	★	★	★	★	●	●	●	●	●	9.525	3.18	1.49

Note: T-DIA is a diamond-based ultra high pressure sintered body. Available in 1-corner type. ● : Line up DX140: 1 piece per package

STANDARD CUTTING CONDITIONS

Please scan below.

e-catalog



ESE3000R

e-catalog



TSE3000R

ESE4000R

Square shoulder endmill, shank type, with wedge clamp system

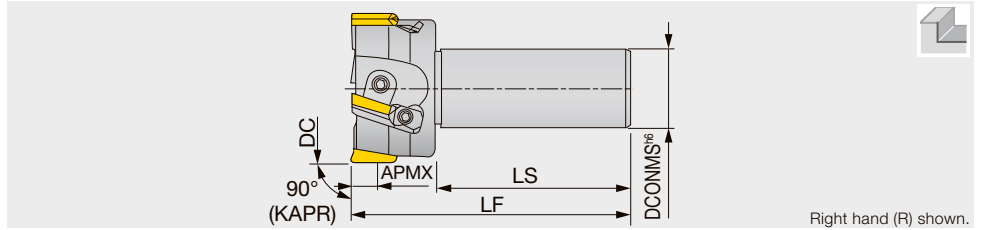

Designation	APMX	DC	CICT	DCONMS	LS	LF	Insert
ESE4050RA	10	50	3	32	80	115	TE*N43/TEKR2204...
ESE4063RA	10	63	4	32	80	115	TE*N43/TEKR2204...
ESE4003RIA-S32	10	80	4	32	80	120	TE*N43/TEKR2204...

ESE4050RA and ESE4063RA do not have variable pitch.

TSE4000RIA

Square shoulder mill, with wedge clamp system

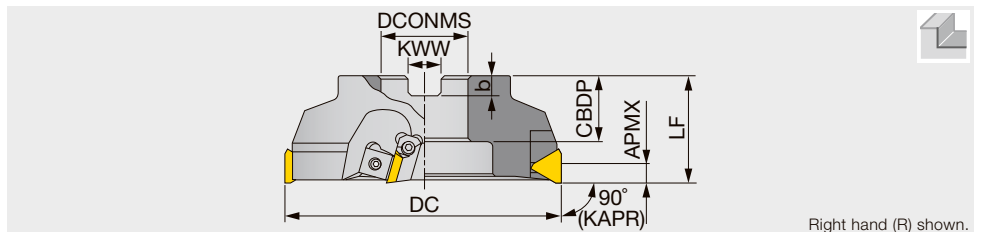

Designation	APMX	DC	CICT	LF	DCONMS	CBDP	KWW	b	WT(kg)	Arbor type
TSE4003RIA	10	80	4	50	25.4	22	9.5	60	1	A
TSE4004RIA	10	100	6	63	31.75	32	12.7	80	1.9	A
TSE4005RIA	10	125	6	63	38.1	38	15.9	100	2.9	B
TSE4006RIA	10	160	8	63	50.8	38	19	110	4.9	B
TSE4008RIA	10	200	10	63	47.625	38	25.4	140	7.4	C
TSE4010RIA	10	250	12	63	47.625	38	25.4	140	13.8	C
TSE4012RIA	10	315	14	63	47.625	38	25.4	140	22.1	D
TSE4003RIAE	10	80	4	50	27	26	12.4	70	1	A
TSE4004RIAE	10	100	6	63	32	32	14.4	80	1.9	A
TSE4005RIAE	10	125	6	63	40	32	16.4	90	2.9	B
TSE4006RIAE	10	160	8	63	40	29	16.4	90	4.9	B

Arbor type

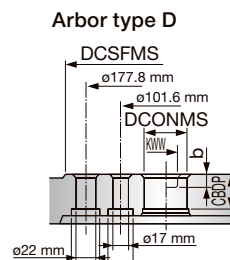
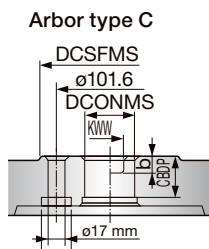
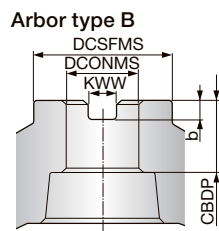
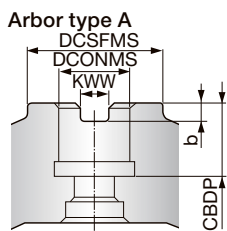

SPARE PARTS

Designation	Locator	Wedge fixing screw	Locator fixing screw	Shell locking bolt	Wedge	Wrench
ESE4050RA	LE402AR	DS-8S	-	SHCM4-10	WT402R	TP-4
ESE4063RA	LE402AR	DS-8	-	SHCM4-10	WT402R	TP-4
ESE4003RIA-S32	LE403R	FDS-8S	CM4X0.7X14	-	WF330N	TP-4
TSE4003RIA	LE403R	FDS-8S	CM4X0.7X14	CAP-CM12X1.75X30	WF330N	TP-4
TSE4004RIA	LE403R	FDS-8S	CM4X0.7X14	CAP-CM16X2.0X40	WF330N	TP-4
TSE4005 - 12...	LE405R	FDS-8S	CM4X0.7X14	-	WF500R	TP-4
TSE4003RIAE, TSE4004RIAE	LE403R	FDS-8S	CM4X0.7X14	-	WF330N	TP-4
TSE4005RIAE, TSE4006RIAE	LE405R	FDS-8S	CM4X0.7X14	-	WF500R	TP-4

Recommended clamping torque : 8 N·m

Reference pages: Inserts → **H176**

INSERT

TECN/TEEN 43Z

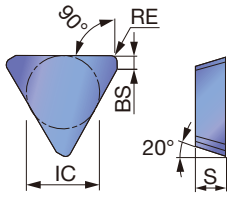

TECN43ZFR-DIA

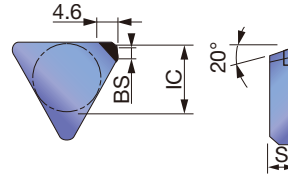

TEKR22-MS

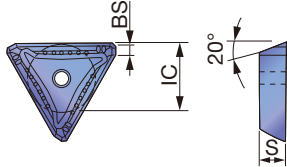

P	Steel	☆	☆	☆	☆	☆	☆	☆	☆	☆	☆	☆	☆	☆	☆	☆	☆	☆	☆	☆	☆	☆
M	Stainless	☆	★	☆	☆	☆	☆	☆	☆	☆	☆	☆	☆	☆	☆	☆	☆	☆	☆	☆	☆	☆
K	Cast iron	★	☆	☆	☆	☆	☆	☆	☆	☆	☆	☆	☆	☆	☆	☆	☆	☆	☆	☆	☆	☆
N	Non-ferrous	☆	☆	☆	☆	☆	☆	☆	☆	☆	☆	☆	☆	☆	☆	☆	☆	☆	☆	☆	☆	☆
S	Superalloys	☆	☆	☆	☆	☆	☆	☆	☆	☆	☆	☆	☆	☆	☆	☆	☆	☆	☆	☆	☆	☆
H	Hard materials	☆	☆	☆	☆	☆	☆	☆	☆	☆	☆	☆	☆	☆	☆	☆	☆	☆	☆	☆	☆	☆

★ : First choice
☆ : Second choice

Designation	RE	APMX	Coated											Cermet		Uncoated		PCD	IC	S	BS					
			AH120	AH130	AH140	AH330	GH330	T1115	T3130	AH3135	T1215	T3225	NS740	N308	UX30	TH10	DX140									
TECN43ZFR	C0.5	10																								
TECN43ZTR	1	10														●	●		●							
TEEN43ZFR	C0.5	10																								
TEEN43ZTR	1	10	●	●	●	●	●	●	●	●	●	●	●	●	●	●	●	●	●	●	●	●	●	●	●	●
TECN43ZFR-DIA	-	3.5																								●
TEKR2204PEPR-MS	-	10		●																						

Note: T-DIA is a diamond-based ultra high pressure sintered body. Available in 1-corner type.

● : Line up
DX140: 1 piece per package

STANDARD CUTTING CONDITIONS

Please scan below.

e-catalog



ESE4000R

e-catalog



TSE4000RIA

TSP4000IA

Square shoulder mill, with wedge clamp system

GAMP = +5°, GAMF = 0°

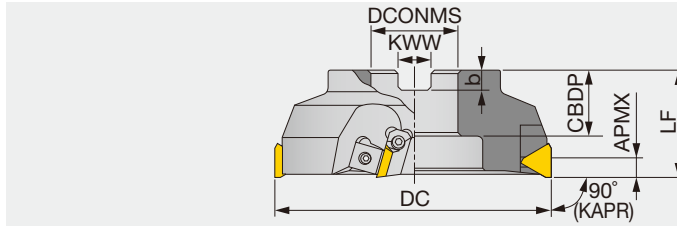

Right hand (R) shown.

Designation	APMX	DC	CICT	LF	DCONMS	CBDP	KWW	b	WT(kg)	Insert
TSP4003RIA	10	80	4	50	25.4	26	9.5	6	1.1	TP*N43 / TP*R...
TSP4004RIA	10	100	6	63	31.75	32	12.7	8	2	TP*N43 / TP*R...
TSP4005RIA	10	125	6	63	38.1	38	15.9	10	3.1	TP*N43 / TP*R...
TSP4006RIA	10	160	8	63	50.8	38	19	11	5.1	TP*N43 / TP*R...
TSP4008RIA	10	200	10	63	47.625	38	25.4	14	7.7	TP*N43 / TP*R...
TSP4010RIA	10	250	12	63	47.625	38	25.4	14	14.1	TP*N43 / TP*R...
TSP4012RIA	10	315	14	63	47.625	38	25.4	14	22.6	TP*N43 / TP*R...

SPARE PARTS

Designation	Locator	Wedge fixing screw	Locator fixing screw	Shell locking bolt	Wedge	Wrench
TSP4003RIA	LP403R	FDS-8S	CM4X0.7X14	CAP-CM12X1.75X30	WF330N	TP-4
TSP4004RIA	LP403R	FDS-8S	CM4X0.7X14	CAP-CM16X2.0X40	WF330N	TP-4
TSP40**RIA	LP405R	FDS-8S	CM4X0.7X14	-	WF500R	TP-4

Recommended clamping torque : 8 N·m

TFP4000IA

Square shoulder mill with finisher

GAMP = +5°, GAMF = 0°

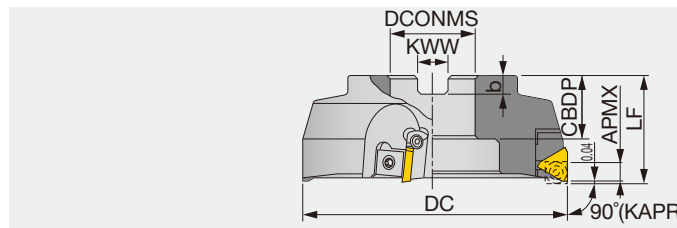

Right hand (R) shown.

Designation	APMX	DC	CICT	LF	DCONMS	CBDP	KWW	b	WT(kg)	Insert
TFP4004RIA	10	100	5	63	31.75	32	12.7	8	2	TP*N43 / TP*R...
TFP4005RIA	10	125	6	63	38.1	38	15.9	10	3.1	TP*N43 / TP*R...
TFP4006RIA	10	160	8	63	50.8	38	19	11	5.2	TP*N43 / TP*R...
TFP4008RIA	10	200	10	63	47.625	38	25.4	14	7.9	TP*N43 / TP*R...

A SPARE PARTS FOR FINISHING INSERT

Designation	Clamping screw	Locator	Wedge fixing screw	Locator fixing screw1	Locator fixing screw2	Wedge	Wrench 1	Wrench 2
TFP40...	CSTA-5S	LW400R	FDS-8S	CM4X0.7X14	CM5X0.8X16	FW-305	T-15D	TP-4

Recommended clamping torque : 8 N·m

B SPARE PARTS FOR REGULAR INSERT

Designation	Clamping screw	Wedge fixing screw	Locator fixing screw	Wedge	Wrench
TFP4004RIA	LP403R	FDS-8S	CM4X0.7X14	WF330N	TP-4
TFP4005 - 08...	LP405R	FDS-8S	CM4X0.7X14	WF500R	TP-4

Recommended clamping torque : 8 N·m

Reference pages: Inserts, → **H178**

INSERT

TPCN/TPEN/TPKN 43Z

TPKR/TPMR-MJ

SPHA-FNW

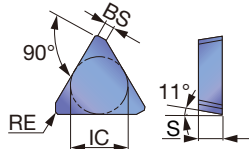

Right hand (R) shown.

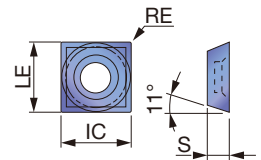
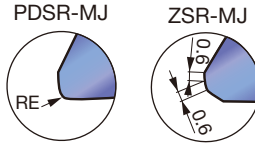
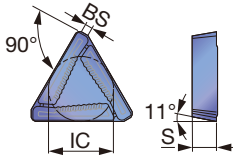

P Steel	★			☆	★	★	☆	☆						
M Stainless		★	★											
K Cast iron	★				★									
N Non-ferrous									★					
S Superalloys	★	☆												
H Hard materials														

★ : First choice
☆ : Second choice

Designation	RE	APMX	Coated					Cermet		Uncoated		IC	LE	S	BS
			AH120	AH130	AH140	GH330	T1115	T3130	NS740	N308	UX30				
TPCN43ZFR	C0.5	10								●		12.7	-	4.76	2
TPCN43ZTR	C0.5	10						● ●	●			12.7	-	4.76	2
TPEN43ZTR	C0.5	10						●				12.7	-	4.76	2
TPEN43ZTRCR	1	10										12.7	-	4.76	2
TPKN43ZFR	C0.5	10								●		12.7	-	4.76	2
TPKN43ZTR	C0.5	10	● ● ● ● ● ●					● ●		●		12.7	-	4.76	2
TPKR43ZSR-MJ	-	10				● ●						12.7	-	4.76	1.5
TPMR2204PDSR-MJ	0.8	10				● ●						12.7	-	4.76	1.2
TPKN43ZFL	C0.5	10								●		12.7	-	4.76	2
SPHA431FNW	0.4	-						●		●		12.7	12.7	4.76	-

● : Line up

STANDARD CUTTING CONDITIONS

Please scan below.

e-catalog



TSP4000IA

e-catalog



TFP4000IA

Approach angle



Others

MEMO

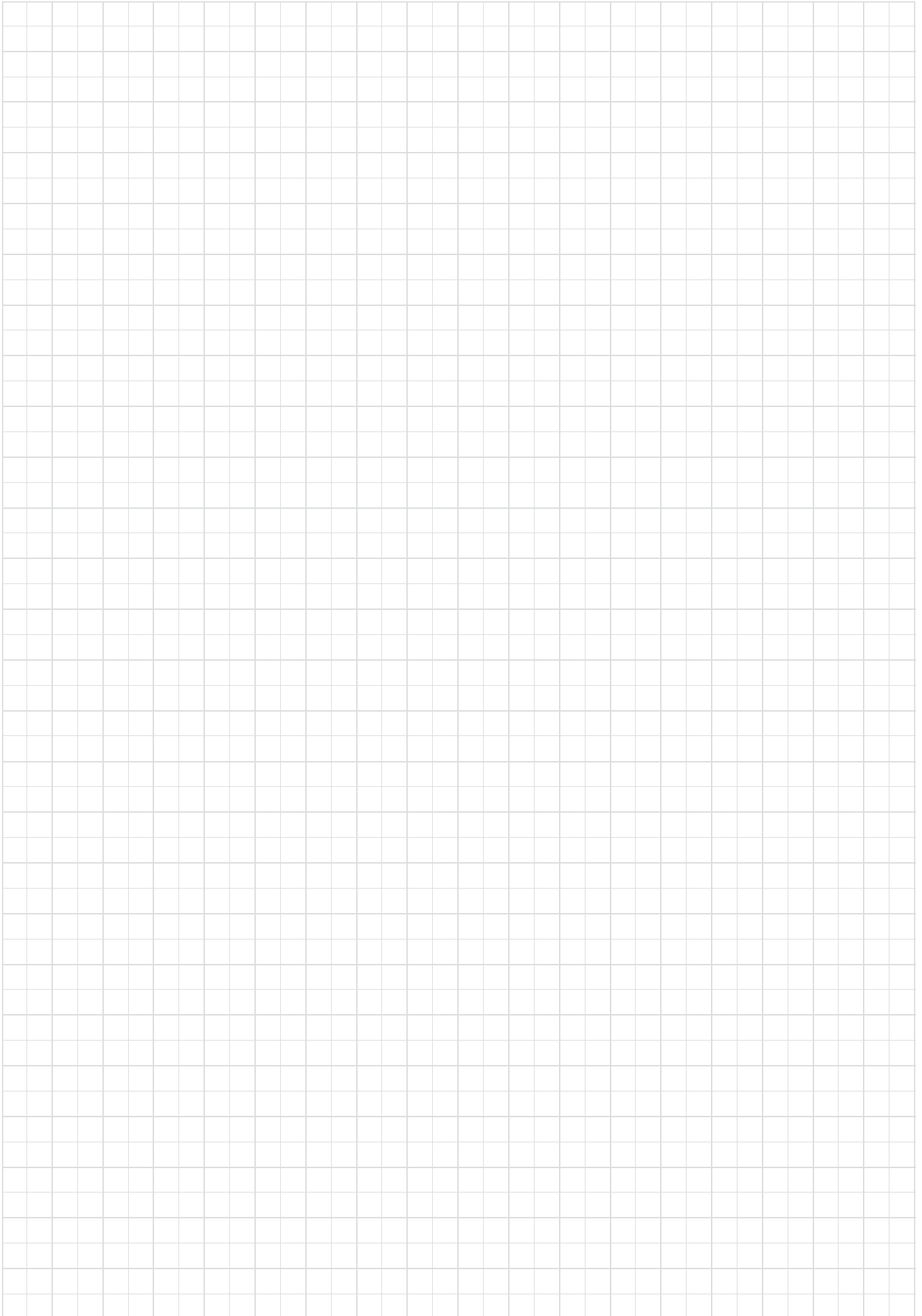
A large grid of small squares, typical of graph paper, intended for writing a memo. The grid covers most of the page below the title and above the footer.

- Grade **A**
- Insert **B**
- Ext. Toolholder **C**
- Int. Toolholder **D**
- Threading **E**
- Grooving **F**
- Miniature tool **G**
- Milling cutter** **H**
- Endmill **I**
- Drilling tool **J**
- Tooling System **K**
- User's Guide **L**
- Index **M**



TUNGUSLOT NIVERSAL

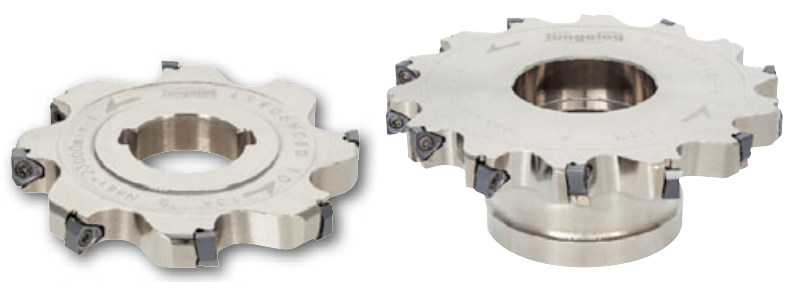

High economy by 6-corner insert with wiper
 Machining stability with the cutter design for optimum chip evacuation

High economy by 6-corner insert

6-corner insert provides economical advantage. Self-wiper edge delivers good surface quality.

TUNGUSLOT
 6 corners with wiper

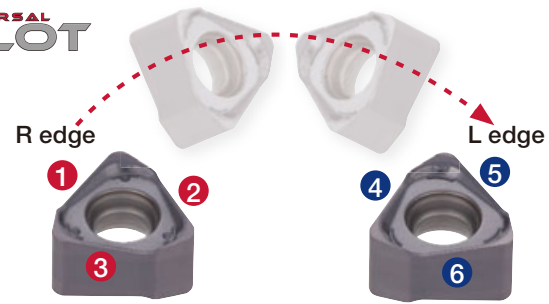

ASW / TSW
 CW = 10, 12, 14, 16 mm

Excellent chip evacuation even in deep slot milling - optimum pocket design

TUNGUSLOT

Competitor

OK



Optimum chipbreaker and big gullets create compact chip formation and smooth evacuation!

X

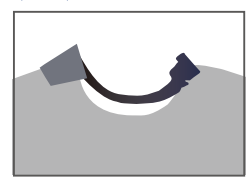

Unformed chip and narrow gullet cause chip packing.

TUNGUSLOT ASW / TSW type

P Steel S55C / C55 (200HB)
 Edge width: CW = 10 mm, Dry
 Corner radius: RE = 0.8 mm

Chips at ae = 30 mm depth

Cutter	Depth of slot: ae (mm)		
	10	20	30
TUNGUSLOT	○	○	○
Competitor A	○	○	✗



Chips are packed because of bad chip control and flow.

Packed chips

Reference pages: **H187 - H188**

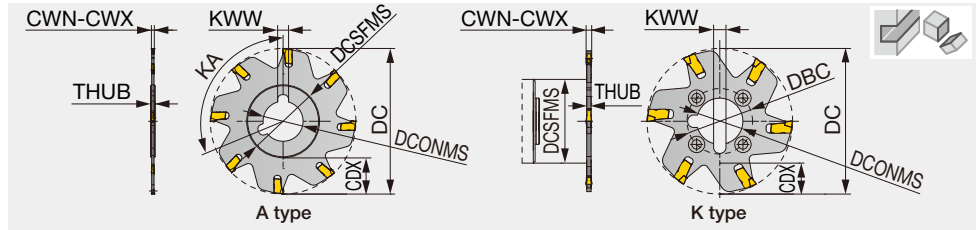

Designation	CW	CWN	CWX	DC	CICT	Seat size	CDX	DCONMS	THUB	DCSFMS	DBC	KA	KWW	SS	SS	Drive flange	Key	Insert
SSG01R063-E1.6	1.6	1.5	1.79	63	6	1	14	10	2.4	32	22	-	3	SW25-32	SW1.00-32	-	K	SSM1*N/ SSS1*N
SSG02R063-E2	2.2	1.8	2.69	63	6	2	15	10	2.4	32	22	-	3	SW25-32	SW1.00-32	-	K	SSM2*N/ SSS2*N
SSG03R063-E3	3.1	2.7	3.53	63	5	3	15	10	2.4	32	22	-	3	SW25-32	SW1.00-32	-	K	SSM3*N/ SSS3*N
SSG04R063-E4	4.1	3.54	4.52	63	5	4	15	10	3.2	32	22	-	3	SW25-32	SW1.00-32	-	K	SSM4*N/ SSS4*N
ASG01N076-1.6	1.6	1.5	1.79	76.2	8	1	14	25.4	2.4	39	-	112.5	6.35	-	-	-	A	SSM1*N/ SSS1*N
ASG02N076-2	2.2	1.8	2.69	76.2	8	2	17	25.4	2.4	39	-	112.5	6.35	-	-	-	A	SSM2*N/ SSS2*N
ASG01N080-E1.6	1.6	1.5	1.79	80	8	1	16	22	2.4	39	-	112.5	6	-	-	-	A	SSM1*N/ SSS1*N
ASG02N080-E2	2.2	1.8	2.69	80	8	2	20	22	2.4	39	-	112.5	6	-	-	-	A	SSM2*N/ SSS2*N
SSG03R080-3	3.1	2.7	3.53	80	6	3	16	25.4	2.4	46	36	-	6.35	SW32- 25.4-46-J	SW1.25-46	R1.00-46	K	SSM3*N/ SSS3*N
SSG03R080-E3	3.1	2.7	3.53	80	6	3	19 ⁽²⁾	22	2.4	40 ⁽¹⁾	32	-	6	SW32-40	-	R 22-46	K	SSM3*N/ SSS3*N
SSG04R080-4	4.1	3.54	4.52	80	6	4	16	25.4	3.2	46	36	-	6.35	SW32- 25.4-46-J	SW1.25-46	R1.00-46	K	SSM4*N/ SSS4*N
SSG04R080-E4	4.1	3.54	4.52	80	6	4	19 ⁽²⁾	22	3.2	40 ⁽¹⁾	32	-	6	SW32-40	-	R 22-46	K	SSM4*N/ SSS4*N
ASG01N100-1.6	1.6	1.5	1.79	100	10	1	30	25.4	2.4	39	-	90	6.35	-	-	-	A	SSM1*N/ SSS1*N
ASG01N100-E1.6	1.6	1.5	1.79	100	10	1	30	22	2.4	39	-	90	6	-	-	-	A	SSM1*N/ SSS1*N
ASG02N100-2	2.2	1.8	2.69	100	10	2	30	25.4	2.4	39	-	90	6.35	-	-	-	A	SSM2*N/ SSS2*N
ASG02N100-E2	2.2	1.8	2.69	100	10	2	30	22	2.4	39	-	90	6	-	-	-	A	SSM2*N/ SSS2*N
SSG03R100-3	3.1	2.7	3.53	100	6	3	26	25.4	2.4	46	36	-	6.35	SW32- 25.4-46-J	SW1.25-46	R1.00-46	K	SSM3*N/ SSS3*N
SSG03R100-E3	3.1	2.7	3.53	100	6	3	29 ⁽³⁾	22	2.4	40 ⁽¹⁾	32	-	6	SW32-40	-	R 22-46	K	SSM3*N/ SSS3*N
SSG04R100-4	4.1	3.54	4.52	100	6	4	26	25.4	3.2	46	36	-	6.35	SW32- 25.4-46-J	SW1.25-46	R1.00-46	K	SSM4*N/ SSS4*N
SSG04R100-E4	4.1	3.54	4.52	100	6	4	29 ⁽³⁾	22	3.2	40 ⁽¹⁾	32	-	6	SW32-40	-	R 22-46	K	SSM4*N/ SSS4*N
ASG01N125-1.6 ⁽⁴⁾	1.6	1.5	1.79	125	12	1	30	31.75	2.4	64	-	75	7.92	-	-	-	A	SSM1*N/ SSS1*N
ASG01N125-E1.6 ⁽⁴⁾	1.6	1.5	1.79	125	12	1	30	27	2.4	64	-	75	7	-	-	-	A	SSM1*N/ SSS1*N
ASG02N125-2 ⁽⁴⁾	2.2	1.8	2.69	125	12	2	32	31.75	2.4	60	-	75	7.92	-	-	-	A	SSM2*N/ SSS2*N
ASG02N125-E2 ⁽⁴⁾	2.2	1.8	2.69	125	12	2	32	27	2.4	60	-	75	7	-	-	-	A	SSM2*N/ SSS2*N
SSG03R125-3 ⁽⁴⁾	3.1	2.7	3.53	125	8	3	34	31.75	2.4	55	45	-	7.92	-	-	R1.25-55	K	SSM3*N/ SSS3*N
SSG03R125-E3 ⁽⁴⁾	3.1	2.7	3.53	125	8	3	34	32	2.4	55	45	-	8	S32-55	-	R 32-55	K	SSM3*N/ SSS3*N
SSG04R125-4 ⁽⁴⁾	4.1	3.54	4.52	125	8	4	34	31.75	3.2	55	45	-	7.92	-	-	R1.25-55	K	SSM4*N/ SSS4*N

(1) When using a drive flange, DCSFMS = 46 mm
 (2) When using a drive flange, CDX = 16 mm
 (3) When using a drive flange, CDX = 26 mm
 (4) Cutters ø125, only one keyway.

CW = When standard inserts are mounted.
 CWN, CWX = When special inserts are mounted.
 Since a single insert cuts the full groove width, use the insert whose width is equal to the groove width in the application.

Tolerance of slot width*

±0.1

*Just for reference

SPARE PARTS

Designation	Grip	Extractor
SSG01/02..., ASG01/02...	ESG0.5	-
SSG03/04...	-	ESG1





INSERT

SSM

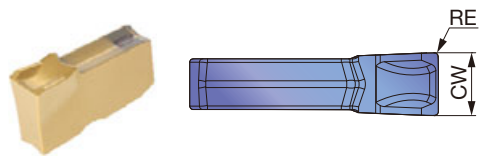

SSS

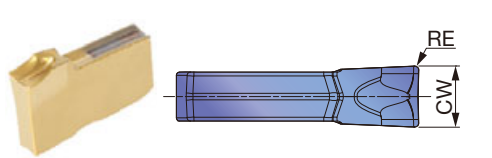

P Steel	★	
M Stainless	★	
K Cast iron	★	
N Non-ferrous		
S Superalloys		
H Hard materials		

★ : First choice
☆ : Second choice

Designation	RE	Coated										CW±0.04
		GH130										
SSM22N	0.2	●										2.2
SSM31N	0.2	●										3.1
SSM41N	0.25	●										4.1
SSS16N	0.16	●										1.6
SSS22N	0.2	●										2.2
SSS31N	0.2	●										3.1
SSS41N	0.25	●										4.1

● : Line up

STANDARD CUTTING CONDITIONS

ISO	Workpiece material	Hardness (HB)	Insert	Cutting speed Vc (m/min)	Chip thickness t (mm)
P	Low carbon steel SS400, S15C, etc. E275A, C15E4, etc.	- 200	SSM...	150 - 230	0.05 - 0.15
	High carbon steel S45C, S55C, etc. E355D, C55, etc.	200 - 300	SSM...	100 - 170	0.04 - 0.13
	Alloy steels SCM440, SCr415, etc. 42CrMo4, 20Cr4, etc.	150 - 300	SSM...	90 - 160	0.04 - 0.13
	Tool steel SKD11, SKD61, etc. X153CrMoV12, X40CrMoV5-1, etc.	- 300	SSM...	70 - 120	0.04 - 0.13
M	Stainless steel SUS304, SUS316, etc. X5CrNi18-9, X5CrNiMo17-12-3, etc.	- 200	SSS...	90 - 200	0.04 - 0.13
K	Grey cast iron FC250, FC300, etc. 250, 300, etc.	150 - 250	SSM...	100 - 200	0.05 - 0.15
	Ductile cast iron FCD400, etc. 400-15S, etc.	150 - 250	SSM...	80 - 130	0.05 - 0.15

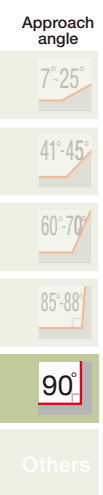

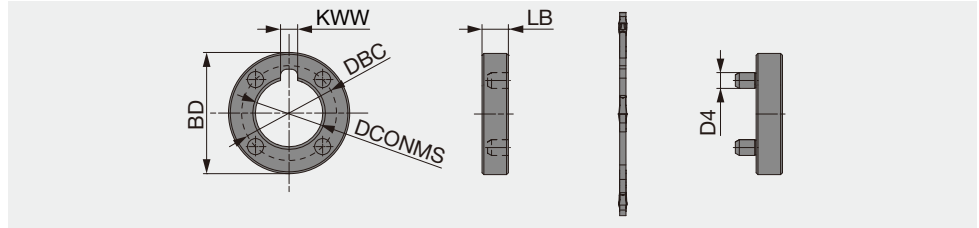

Designation	DCONMS	BD	D4	DBC	LB	KWW
R22-46	22	46	6	32	10	6
R1.00-46	25.4	46	5	36	10	6.35
R1.25-55	31.75	55	6	45	10	7.92
R32-55	32	55	6	45	10	8

SW

Drive shank for side cutters

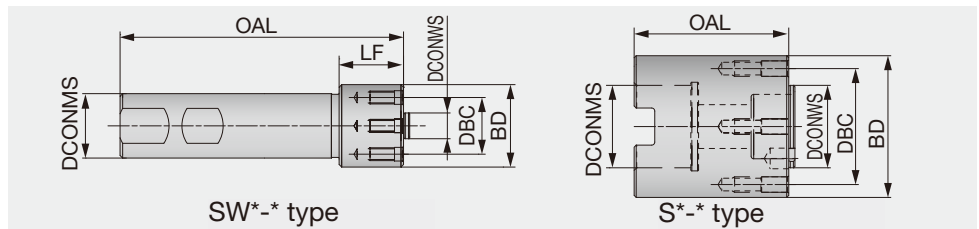

Designation	DCONMS	DCONMS	DCONWS	BD	DBC	LF	OAL
SW25-32	25	-	10	32	22	25	110
SW1.00-32	25.4	-	10	32	22	25.4	110
SW1.25-46	31.75	-	25.4	46	36	30	120
SW32-40	32	-	22	40	32	30	120
SW32-25.4-46-J	32	-	25.4	46	36	30	120
S32-55	-	32	32	55	45	-	60

SPARE PARTS



Designation	Screw	Wrench		
		Mono block type	Torx bit	Grip
SW25-32, SW1.00-32	SR76-961	SETT-15/5	-	-
SW32-40, SW32-25.4-46-J, SW1.25-46	SR76-963	SETT-15/5	-	-
S32-55	SR76-943	-	BT20M	H-TB



- High Feed Milling
- Face Milling
- Shoulder Milling
- Slot Milling
- Profile Milling
- Chamfering, Counterbore
- Finish Face Milling
- Approach angle
 - 7°-25°
 - 41°-45°
 - 60°-70°
 - 85°-88°
 - 90°
- Others

COMBINATION OF ARBORS / ATTACHMENTS

Cutter bodies : "A" type

A-type disk cutters are without clamping holes on the hub and can be mounted only by using axial drive arbors.



Axial drive arbor

Cutter bodies : "K" type

K-type disk cutters are with clamping holes on the hub and can be mounted by using intermediate shanks or shell adaptors, making it possible to use endmills / shell mill arbors.

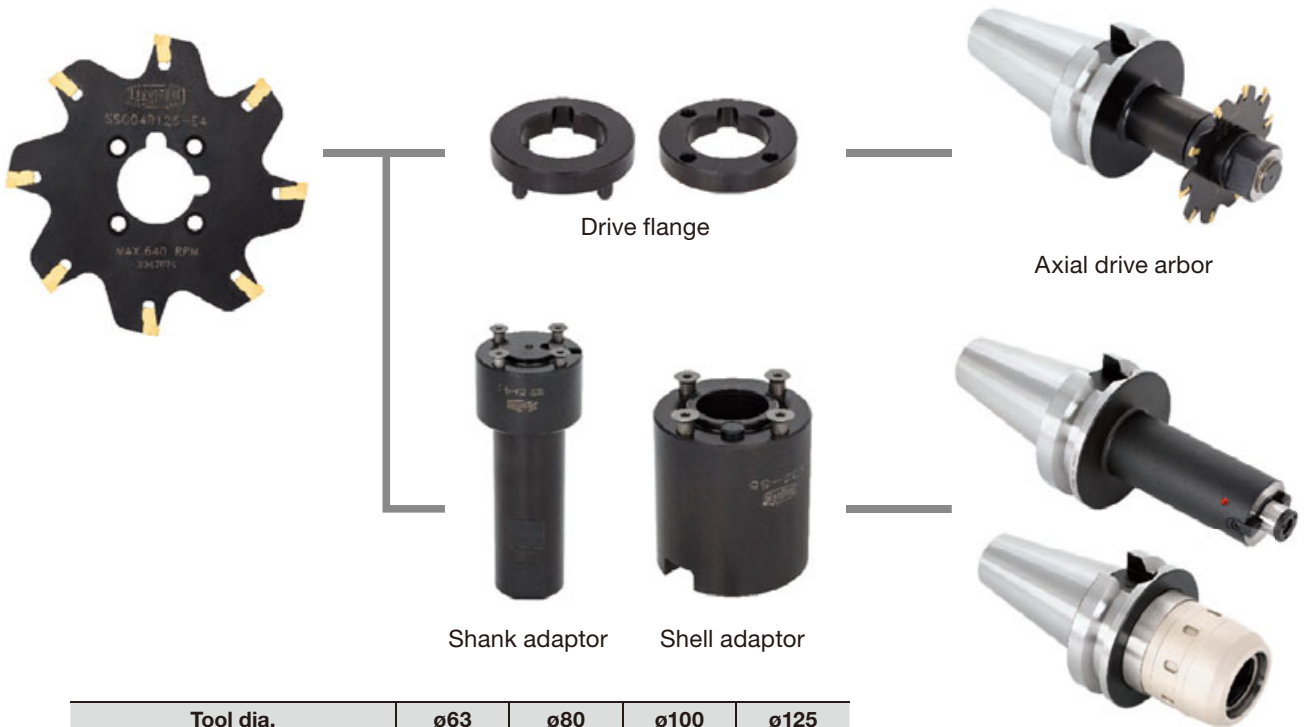

Drive flange

Axial drive arbor

Shank adaptor

Shell adaptor

Shell mill / Endmill arbor

Tool dia.	ø63	ø80	ø100	ø125
Drive flange	-	✓	✓	✓
Shank / Shell adaptor	✓	✓	✓	✓

Axial drive slot mill, for tangentially mounted inserts

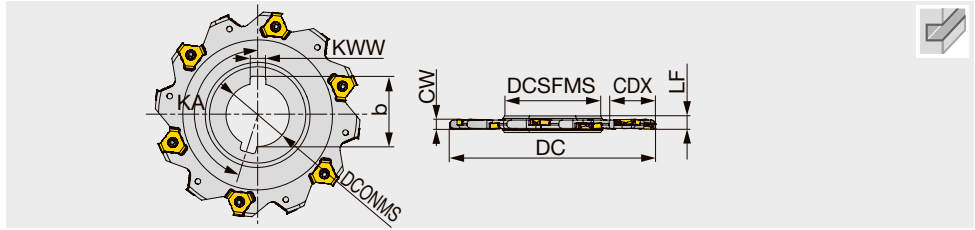

Designation	CW	DC	ZEFP/CICT	DCSFMS	DCONMS	LF	b	KWW	CDX	KA	Insert
ASV02N080-4	4	80	5/10	41	25.4	6	28	6.35	15	162	TVKX0202...
ASV02N080-E4	4	80	5/10	41	27	6	29.8	7	15	162	TVKX0202...
ASV03N080-5	5	80	5/10	41	25.4	6.5	28	6.35	15	162	TVKX03X3...
ASV03N080-E5	5	80	5/10	41	27	6.5	29.8	7	15	162	TVKX03X3...
ASV04N080-6	6	80	4/8	41	25.4	8	28	6.35	17	157.5	TVKX04H3...
ASV04N080-E6	6	80	4/8	41	27	8	29.8	7	17	157.5	TVKX04H3...
ASV05N080-8	8	80	4/8	41	25.4	10	28	6.35	17	157.5	TVKX0504...
ASV05N080-E8	8	80	4/8	41	27	10	29.8	7	17	157.5	TVKX0504...
ASV02N100-4	4	100	6/12	48	31.75	6	35.2	7.92	20	165	TVKX0202...
ASV02N100-E4	4	100	6/12	47	32	6	34.8	8	20	165	TVKX0202...
ASV03N100-5	5	100	6/12	48	31.75	6.5	35.2	7.92	20	165	TVKX03X3...
ASV03N100-E5	5	100	6/12	47	32	6.5	34.8	8	20	165	TVKX03X3...
ASV04N100-6	6	100	5/10	48	31.75	8	35.2	7.92	23.5	162	TVKX04H3...
ASV04N100-E6	6	100	5/10	47	32	8	34.8	8	23.5	162	TVKX04H3...
ASV05N100-8	8	100	5/10	48	31.75	10	35.2	7.92	23.5	162	TVKX0504...
ASV05N100-E8	8	100	5/10	47	32	10	34.8	8	23.5	162	TVKX0504...
ASV02N125-4	4	125	8/16	58	38.1	6	42.3	9.52	30	168.75	TVKX0202...
ASV02N125-E4	4	125	8/16	55	40	6	43.5	10	30	168.75	TVKX0202...
ASV03N125-5	5	125	8/16	58	38.1	6.5	42.3	9.52	30	168.75	TVKX03X3...
ASV03N125-E5	5	125	8/16	55	40	6.5	43.5	10	30	168.75	TVKX03X3...
ASV04N125-6	6	125	6/12	58	38.1	8	42.3	9.52	31	165	TVKX04H3...
ASV04N125-E6	6	125	6/12	55	40	8	43.5	10	32.5	165	TVKX04H3...
ASV05N125-8	8	125	6/12	58	38.1	10	42.3	9.52	31	165	TVKX0504...
ASV05N125-E8	8	125	6/12	55	40	10	43.5	10	32.5	165	TVKX0504...
ASV02N160-4	4	160	10/20	58	38.1	6	42.3	9.52	45	171	TVKX0202...
ASV02N160-E4	4	160	10/20	55	40	6	43.5	10	45	171	TVKX0202...
ASV03N160-5	5	160	10/20	58	38.1	6.5	42.3	9.52	45	171	TVKX03X3...
ASV03N160-E5	5	160	10/20	55	40	6.5	43.5	10	45	171	TVKX03X3...
ASV04N160-6	6	160	8/16	58	38.1	8	42.3	9.52	48.5	168.75	TVKX04H3...
ASV04N160-E6	6	160	8/16	55	40	8	43.5	10	50	168.75	TVKX04H3...
ASV05N160-8	8	160	8/16	58	38.1	10	42.3	9.52	48.5	168.75	TVKX0504...
ASV05N160-E8	8	160	8/16	55	40	10	43.5	10	50	168.75	TVKX0504...
ASV04N200-6	6	200	10/20	69	50.8	8	55.8	12.7	63	171	TVKX04H3...
ASV04N200-E6	6	200	10/20	69	50	8	53.5	12	63	171	TVKX04H3...
ASV05N200-8	8	200	10/20	69	50.8	10	55.8	12.7	63	171	TVKX0504...
ASV05N200-E8	8	200	10/20	69	50	10	53.5	12	63	171	TVKX0504...

SPARE PARTS

Designation	Clamping screw	Grip	Lubricant	Torx bit	Mono block type Torx bit
ASV02/03N...	SR114-018-L3.40	-	M-1000	-	T-6D
ASV04N...	SR14-500-L5.1	H-TB2W	M-1000	BT15S	-
ASV05N...	SR14-500-L7.0	H-TB2W	M-1000	BT15S	-

Recommended clamping torque: SR114-018-L3.40 = 0.7 N·m, SR14-500/L5.1, SR14-500-L7.0 = 3.5 N·m





INSERT

TVKX-MJ

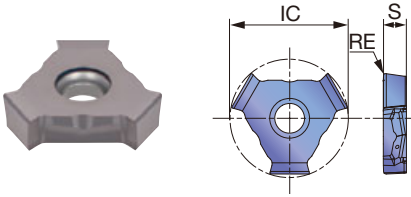

P Steel	☆	★	★	★
M Stainless	★	☆	☆	☆
K Cast iron	★	☆	☆	☆
N Non-ferrous				
S Superalloys	★	☆	★	★
H Hard materials				

★ : First choice
☆ : Second choice

Designation	RE	Coated				S	IC
		AH120	AH130	AH725	SH725		
TVKX020202TN-MJ	0.2	●	●			2.4	9.4
TVKX020202FN-MJ	0.2			●		2.4	9.4
TVKX020204TN-MJ	0.4	●	●			2.4	9.4
TVKX03X302TN-MJ	0.2	●	●			3.2	9.4
TVKX03X302FN-MJ	0.2			●		3.2	9.4
TVKX03X304TN-MJ	0.4	●	●			3.2	9.4
TVKX04H302FN-MJ	0.2			●		3.5	16.9
TVKX04H304TN-MJ	0.4	●	●	●		3.5	16.9
TVKX04H308TN-MJ	0.8	●	●	●		3.5	16.9
TVKX050402FN-MJ	0.2			●		4.5	16.9
TVKX050404TN-MJ	0.4	●	●	●		4.5	16.9
TVKX050408TN-MJ	0.8	●	●	●		4.5	16.9

● : Line up

Approach angle

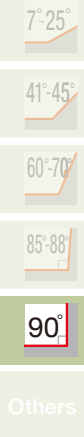

Others

STANDARD CUTTING CONDITIONS

ISO	Workpiece material	Hardness	Priority	Grade	Cutting speed Vc (m/min)	Feed per edge line: fz (mm/t)			
						ASV		ASV	
						ae / DC (mm)		ae / DC (mm)	
		10%	20%	30%	≤ 50%				
P	Low carbon steels SS400, etc. E275A, etc.	- 200 HB	First choice	AH725	90 - 180	0.08 - 0.25	0.06 - 0.19	0.05 - 0.16	0.05 - 0.15
			Fracture resistance	AH130	90 - 180	0.08 - 0.25	0.06 - 0.19	0.05 - 0.16	0.05 - 0.15
	High carbon steels S45C, etc. C45, etc.	200 - 300 HB	First choice	AH725	90 - 180	0.07 - 0.22	0.05 - 0.16	0.04 - 0.14	0.04 - 0.13
			Fracture resistance	AH130	90 - 180	0.07 - 0.22	0.05 - 0.16	0.04 - 0.14	0.04 - 0.13
	Alloy steels SCM440, etc. 42CrMo4, etc.	150 - 300 HB	First choice	AH725	90 - 180	0.07 - 0.22	0.05 - 0.16	0.04 - 0.14	0.04 - 0.13
			Fracture resistance	AH130	90 - 180	0.07 - 0.22	0.05 - 0.16	0.04 - 0.14	0.04 - 0.13
Tool steels SKD61, etc. X40CrMoV5-1, etc.	- 300 HB	First choice	AH725	90 - 180	0.07 - 0.22	0.05 - 0.16	0.04 - 0.14	0.04 - 0.13	
		Fracture resistance	AH130	90 - 180	0.07 - 0.22	0.05 - 0.16	0.04 - 0.14	0.04 - 0.13	
M	Stainless steel SUS304, etc. X5CrNi18-9, etc.	- 200 HB		AH130	90 - 200	0.07 - 0.22	0.05 - 0.16	0.04 - 0.14	0.04 - 0.13
K	Grey cast irons FC250, etc. 250, etc.	150 - 250 HB		AH120	120 - 230	0.08 - 0.25	0.06 - 0.19	0.05 - 0.16	0.05 - 0.15
	Ductile cast irons FCD400, etc. 400-15S, etc.	150 - 250 HB		AH120	90 - 150	0.08 - 0.25	0.06 - 0.19	0.05 - 0.16	0.05 - 0.15
S	Titanium alloys Ti-6Al-4V, etc.	- 40 HRC	First choice	AH725	30 - 40	0.07 - 0.12	0.05 - 0.09	0.04 - 0.07	0.04 - 0.07
			Fracture resistance	AH130	30 - 40	0.07 - 0.12	0.05 - 0.09	0.04 - 0.07	0.04 - 0.07
	Nickel-based alloys Inconel 718, etc.	- 40 HRC	First choice	AH725	20 - 35	0.07 - 0.12	0.05 - 0.09	0.04 - 0.07	0.04 - 0.07
			Fracture resistance	AH130	20 - 35	0.07 - 0.12	0.05 - 0.09	0.04 - 0.07	0.04 - 0.07

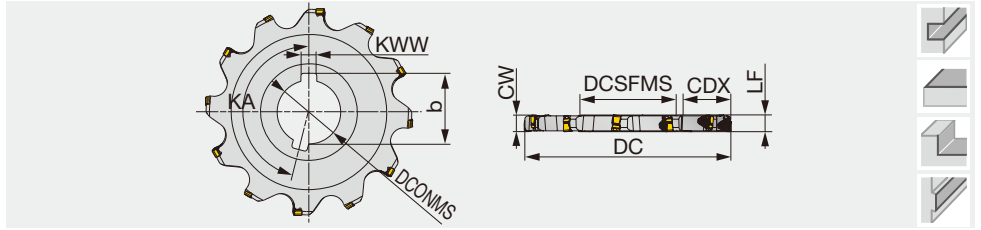

Designation	CW	DC	ZEFP/CICT	DCSFMS	DCONMS	LF	b	KWW	CDX	KA	Insert
ASW06N080-10	10	80	4/8	41	25.4	10	28	6.35	18.5	157.5	WNGU0603...
ASW06N080-E10	10	80	4/8	41	27	10	29.8	7	18.5	157.5	WNGU0603...
ASW06N100-10	10	100	5/10	48	31.75	10	35.2	7.92	25	162	WNGU0603...
ASW06N100-E10	10	100	5/10	47	32	10	34.8	8	25.5	162	WNGU0603...
ASW07N100-12	12	100	5/10	48	31.75	12	35.2	7.92	25	162	WNGU07T3...
ASW07N100-E12	12	100	5/10	47	32	12	34.8	8	25.5	162	WNGU07T3...
ASW09N100-14	14	100	5/10	48	31.75	14	35.2	7.92	25	162	WNGU0904...
ASW09N100-E14	14	100	5/10	47	32	14	34.8	8	25.5	162	WNGU0904...
ASW07N125-12	12	125	6/12	58	38.1	12	42.3	9.52	32.5	165	WNGU07T3...
ASW07N125-E12	12	125	6/12	55	40	12	43.5	10	34	165	WNGU07T3...
ASW06N125-10	10	125	6/12	58	38.1	10	42.3	9.52	32.5	165	WNGU0603...
ASW06N125-E10	10	125	6/12	55	40	10	43.5	10	34	165	WNGU0603...
ASW06N160-10	10	160	7/14	58	38.1	10	42.3	9.52	50	167.14	WNGU0603...
ASW06N160-E10	10	160	7/14	55	40	10	43.5	10	51.5	167.14	WNGU0603...
ASW07N160-12	12	160	7/14	58	38.1	12	42.3	9.52	50	167.14	WNGU07T3...
ASW07N160-E12	12	160	7/14	55	40	12	43.5	10	51.5	167.14	WNGU07T3...
ASW09N160-14	14	160	7/14	58	38.1	14	42.3	9.52	50	167.14	WNGU0904...
ASW09N160-E14	14	160	7/14	55	40	14	43.5	10	51.5	167.14	WNGU0904...
ASW09N160-16	16	160	7/14	58	38.1	16	42.3	9.52	50	167.14	WNGU0904...
ASW09N160-E16	16	160	7/14	55	40	16	43.5	10	51.5	167.14	WNGU0904...

SPARE PARTS

Designation	Clamping screw1	Clamping screw2	Grip 1	Grip 2	Lubricant	Torx bit	Wrench
ASW06N...	-	CSPB-2.5	-	-	M-1000	-	IP-8D
ASW07N100/125-...	-	CSPD-3	-	SW6-SD	M-1000	BLD IP10/S7	-
ASW07N160-...	-	CSPD-3	-	-	M-1000	-	IP-10D
ASW09N100-...	CSPB-3.5	-	H-TB2W	-	M-1000	BLDIP15/S7	-
ASW09N160-...	CSPB-3.5	-	-	-	M-1000	-	IP-15D

Recommended clamping torque: CSPB-2.5 = 1.3 N·m, CSPB-3.5 = 3.5 N·m, CSPD-3 = 2.5 N·m





Radial drive slot mill

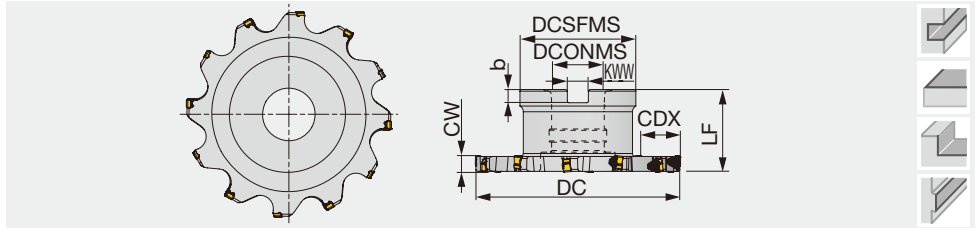

Designation	CW	DC	ZEPF/CICT	DCSFMS	DCONMS	LF	b	KWW	CDX	Insert
TSW06R100-10	10	100	5/10	50	25.4	50	6	9.5	24	WNGU0603...
TSW06R100-E10	10	100	5/10	58	27	50	7	12.4	20	WNGU0603...
TSW07R100-12	12	100	5/10	50	25.4	50	6	9.5	24	WNGU07T3...
TSW07R100-E12	12	100	5/10	58	27	50	7	12.4	20	WNGU07T3...
TSW06R125-10	10	125	6/12	70	31.75	50	8	12.7	26.5	WNGU0603...
TSW06R125-E10	10	125	6/12	66	32	50	8	14.4	28.5	WNGU0603...
TSW07R125-12	12	125	6/12	70	31.75	50	8	12.7	26.5	WNGU07T3...
TSW07R125-E12	12	125	6/12	66	32	50	8	14.4	28.5	WNGU07T3...
TSW06R160-10	10	160	7/14	100	38.1	63	10	15.9	29	WNGU0603...
TSW06R160-E10	10	160	7/14	82	40	63	9	16.4	38	WNGU0603...
TSW07R160-12	12	160	7/14	100	38.1	63	10	15.9	29	WNGU07T3...
TSW07R160-E12	12	160	7/14	82	40	63	9	16.4	38	WNGU07T3...
TSW09R160-16	16	160	7/14	100	38.1	63	10	15.9	29	WNGU0904...
TSW09R160-E16	16	160	7/14	82	40	63	9	16.4	38	WNGU0904...

SPARE PARTS

Designation	Clamping screw1	Clamping screw2	Grip	Lubricant	Torx bit	Mono block type Torx bit
TSW06R...	-	CSPB-2.5	-	M-1000	-	IP-8D
TSW07R100/125-...	-	CSPD-3	SW6-SD	M-1000	BLD IP10/S7	-
TSW07R160-...	-	CSPD-3	-	M-1000	-	IP-10D
TSW09R160-...	CSPB-3.5	-	-	M-1000	-	IP-15D

Recommended clamping torque: CSPB-2.5 = 1.3 N·m, CSPB-3.5 = 3.5 N·m, CSPD-3 = 2.5 N·m

Approach angle

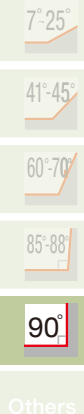

Others

INSERT

WNGU-MJ

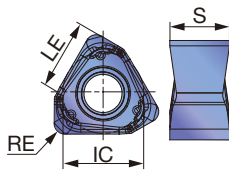

	P	M	K	N	S	H
Steel	☆		★	★		
Stainless		★	☆	★		
Cast iron	★		☆			
Non-ferrous						
Superalloys	★	☆	★			
Hard materials						

★ : First choice
☆ : Second choice

Designation	RE	Coated				LE	IC	S
		AH120	AH130	AH725	AH3135			
WNGU060304TN-MJ	0.4	●			●	5.6	6.1	4.4
WNGU060308TN-MJ	0.8	●	●	●	●	5.6	6.1	4.4
WNGU060310TN-MJ	1	●	●	●	●	5.6	6.1	4.4
WNGU060316TN-MJ	1.6	●	●	●		5.6	6.1	4.4
WNGU060320TN-MJ	2	●			●	5.6	6.1	4.4
WNGU07T304TN-MJ	0.4	●			●	6.8	7.4	5.5
WNGU07T308TN-MJ	0.8	●	●	●		6.8	7.4	5.5
WNGU07T310TN-MJ	1	●	●	●	●	6.8	7.4	5.5
WNGU07T316TN-MJ	1.6	●	●	●		6.8	7.4	5.5
WNGU07T320TN-MJ	2	●			●	6.8	7.4	5.5
WNGU090404TN-MJ	0.4	●			●	8.5	8.6	6.5
WNGU090408TN-MJ	0.8	●	●	●		8.5	8.6	6.5
WNGU090410TN-MJ	1	●	●	●	●	8.5	8.6	6.5
WNGU090416TN-MJ	1.6	●	●	●		8.5	8.6	6.5
WNGU090420TN-MJ	2	●			●	8.5	8.6	6.5

● : Line up

STANDARD CUTTING CONDITIONS

ISO	Workpiece material	Hardness	Priority	Grade	Cutting speed Vc (m/min)	Feed per edge line: fz (mm/t)			
						TSW / ASW			
						ae / DC (mm)			
		10%	20%	30%	≤ 50%				
P	Low carbon steels SS400, etc. E275A, etc.	- 200 HB	First choice	AH725	90 - 180	0.12 - 0.33	0.09 - 0.25	0.07 - 0.21	0.07 - 0.2
			Fracture resistance	AH130	90 - 180	0.12 - 0.33	0.09 - 0.25	0.07 - 0.21	0.07 - 0.2
	High carbon steels S45C, etc. C45, etc.	200 - 300 HB	First choice	AH725	90 - 180	0.12 - 0.33	0.09 - 0.25	0.07 - 0.21	0.07 - 0.2
			Fracture resistance	AH130	90 - 180	0.12 - 0.33	0.09 - 0.25	0.07 - 0.21	0.07 - 0.2
	Alloy steels SCM440, etc. 42CrMo4, etc.	150 - 300 HB	First choice	AH725	90 - 180	0.12 - 0.33	0.09 - 0.25	0.07 - 0.21	0.07 - 0.2
			Fracture resistance	AH130	90 - 180	0.12 - 0.33	0.09 - 0.25	0.07 - 0.21	0.07 - 0.2
	Tool steels SKD61, etc. X40CrMoV5-1, etc.	- 300 HB	First choice	AH725	90 - 180	0.12 - 0.33	0.09 - 0.25	0.07 - 0.21	0.07 - 0.2
			Fracture resistance	AH130	90 - 180	0.12 - 0.33	0.09 - 0.25	0.07 - 0.21	0.07 - 0.2
M	Stainless steel SUS304, etc. X5CrNi18-9, etc.	- 200 HB	First choice	AH130	90 - 200	0.12 - 0.33	0.09 - 0.25	0.07 - 0.21	0.07 - 0.2
			Fracture resistance	AH130	90 - 200	0.12 - 0.33	0.09 - 0.25	0.07 - 0.21	0.07 - 0.2
K	Grey cast irons FC250, etc. 250, etc.	150 - 250 HB	-	AH120	120 - 230	0.12 - 0.42	0.09 - 0.31	0.07 - 0.27	0.07 - 0.25
	Ductile cast irons FCD400, etc. 400-15S, etc.	150 - 250 HB	-	AH120	90 - 150	0.12 - 0.42	0.09 - 0.31	0.07 - 0.27	0.07 - 0.25
S	Titanium alloys Ti-6Al-4V, etc.	- 40 HRC	First choice	AH725	30 - 40	0.1 - 0.17	0.08 - 0.13	0.06 - 0.11	0.06 - 0.1
			Fracture resistance	AH130	30 - 40	0.1 - 0.17	0.08 - 0.13	0.06 - 0.11	0.06 - 0.1
	Nickel-based alloys Inconel 718, etc.	- 40 HRC	First choice	AH725	20 - 35	0.1 - 0.17	0.08 - 0.13	0.06 - 0.11	0.06 - 0.1
			Fracture resistance	AH130	20 - 35	0.1 - 0.17	0.08 - 0.13	0.06 - 0.11	0.06 - 0.1

TEC TANGENTIAL SLOTT ASN 10/12/15

Axial drive slot mill, for tangentially mounted inserts

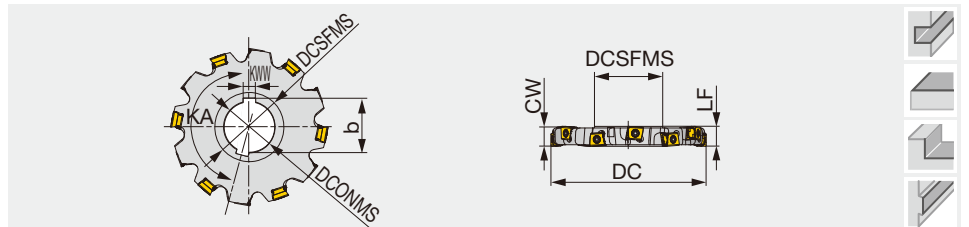

Designation	CW	DC	ZEFP	CICT	DCSFMS	DCONMS	LF	b	KWW	CDX	KA	Insert
ASN10R100M31.7-16-05	16	100	5	10	48	31.75	16	35.2	7.92	25	162	LMEU1008**ZNEN-MJ
ASN10R100M32.0E16-05	16	100	5	10	47	32	16	34.8	8	25.5	162	LMEU1008**ZNEN-MJ
ASN12R100M31.7-19-05	19	100	5	10	48	31.75	19	35.2	7.92	25	162	LMEU1206**ZNEN-MJ
ASN12R100M32.0E19-05	19	100	5	10	47	32	19	34.8	8	25.5	162	LMEU1208**ZNEN-MJ
ASN10R125M38.1-16-06	16	125	6	12	58	38.1	16	42.3	9.52	32.5	165	LMEU1008**ZNEN-MJ
ASN10R125M40.0E16-06	16	125	6	12	55	40	16	43.5	10	34	165	LMEU1008**ZNEN-MJ
ASN12R125M38.1-19-06	19	125	6	12	58	38.1	19	42.3	9.52	32.5	165	LMEU1206**ZNEN-MJ
ASN12R125M40.0E19-06	19	125	6	12	55	40	19	43.5	10	34	165	LMEU1208**ZNEN-MJ
ASN15R125M38.1-25-05	25	125	5	10	58	38.1	25	42.3	9.52	32.5	162	LMEU1509**ZNEN-MJ
ASN15R125M40.0E25-05	25	125	5	10	55	40	25	43.5	10	34	165	LMEU1509**ZNEN-MJ
ASN10R160M38.1-16-07	16	160	7	14	58	38.1	16	42.3	9.52	50	167.14	LMEU1008**ZNEN-MJ
ASN10R160M40.0E16-07	16	160	7	14	55	40	16	43.5	10	51.5	167.14	LMEU1008**ZNEN-MJ
ASN12R160M38.1-19-07	19	160	7	14	58	38.1	19	42.3	9.52	50	167.14	LMEU1206**ZNEN-MJ
ASN12R160M40.0E19-07	19	160	7	14	55	40	19	43.5	10	51.5	167.14	LMEU1208**ZNEN-MJ
ASN15R160M38.1-25-06	25	160	6	12	58	38.1	25	42.3	9.52	50	165	LMEU1509**ZNEN-MJ
ASN15R160M40.0E25-06	25	160	6	12	55	40	25	43.5	10	51.5	167.14	LMEU1509**ZNEN-MJ
ASN10R200M50.0E16-08	16	200	8	16	69	50	16	53.6	12	64.5	168.75	LMEU1008**ZNEN-MJ
ASN12R200M50.0E19-08	19	200	8	16	69	50	19	53.6	12	64.5	168.75	LMEU1208**ZNEN-MJ
ASN12R250M50.0E19-09	19	250	9	18	84	50	19	53.6	12	82	170	LMEU1208**ZNEN-MJ
ASN15R200M50.0E25-07	25	200	7	14	69	50	25	53.6	12	64.5	168.75	LMEU1509**ZNEN-MJ
ASN15R250M50.0E25-08	25	250	8	16	84	50	25	53.6	12	82	170	LMEU1509**ZNEN-MJ

SPARE PARTS

Designation	Clamping screw	Grip	Torx bit
ASN10/12R...	SM40-143-H0	H-TB	BT15S
ASN15R...	CSTB-5L159	H-TB	BT20S

Reference pages: Inserts, Standard cutting conditions
→ **H191**

Recommended clamping torque: SM40-143-H0 = 3.5 N·m, CSTB-5L159 = 5 N·m



Radial drive slot mill, for tangentially mounted inserts

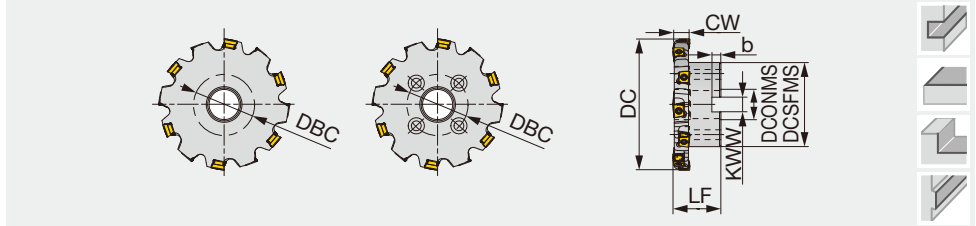
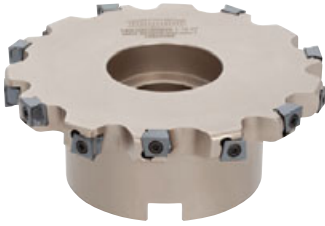

Designation	CW	DC	ZEFP	CICT	DCSFMS	DCONMS	LF	b	KWW	CDX	DBC	Insert
TSN10R100M25.4-16-05	16	100	5	10	50	25.4	50	6	9.5	24	-	LMEU1008**ZNEN-MJ
TSN10R100M27.0E16-05	16	100	5	10	58	27	50	7	12.4	20	-	LMEU1008**ZNEN-MJ
TSN12R100M25.4-19-05	19	100	5	10	50	25.4	50	6	9.5	24	-	LMEU1208**ZNEN-MJ
TSN12R100M27.0E19-05	19	100	5	10	58	27	50	7	12.4	20	-	LMEU1208**ZNEN-MJ
TSN10R125M31.7-16-06	16	125	6	12	70	31.75	50	8	12.7	26.5	-	LMEU1008**ZNEN-MJ
TSN10R125M32.0E16-06	16	125	6	12	66	32	50	8	14.4	28.5	-	LMEU1008**ZNEN-MJ
TSN12R125M31.7-19-06	19	125	6	12	70	31.75	50	8	12.7	26.5	-	LMEU1208**ZNEN-MJ
TSN12R125M32.0E19-06	19	125	6	12	66	32	50	8	14.4	28.5	-	LMEU1208**ZNEN-MJ
TSN15R125M31.7-25-05	25	125	5	10	70	31.75	50	8	12.7	26.5	-	LMEU1509**ZNEN-MJ
TSN15R125M32.0E25-05	25	125	5	10	66	32	50	8	14.4	28.5	-	LMEU1509**ZNEN-MJ
TSN10R160M38.1-16-07	16	160	7	14	100	38.1	63	10	15.9	29	-	LMEU1008**ZNEN-MJ
TSN10R160M40.0E16-07	16	160	7	14	82	40	63	9	16.4	38	-	LMEU1008**ZNEN-MJ
TSN12R160M38.1-19-07	19	160	7	14	100	38.1	63	10	15.9	29	-	LMEU1208**ZNEN-MJ
TSN12R160M40.0E19-07	19	160	7	14	82	40	63	9	16.4	38	-	LMEU1208**ZNEN-MJ
TSN15R160M38.1-25-06	25	160	6	12	100	38.1	63	10	15.9	29	-	LMEU1509**ZNEN-MJ
TSN15R160M40.0E25-06	25	160	6	12	82	40	63	9	16.4	38	-	LMEU1509**ZNEN-MJ
TSN10R200M40.0E16-08	16	200	8	16	95	40	63	9	16.4	55	66.7	LMEU1008**ZNEN-MJ
TSN10R200M47.6-16-08	16	200	8	16	135	47.625	63	14	25.4	31.5	101.6	LMEU1008**ZNEN-MJ
TSN12R200M40.0E19-08	19	200	8	16	95	40	63	9	16.4	55	66.7	LMEU1208**ZNEN-MJ
TSN12R200M47.6-19-08	19	200	8	16	135	47.625	63	14	25.4	31.5	101.6	LMEU1208**ZNEN-MJ
TSN15R200M40.0E25-07	25	200	7	14	95	40	63	9	16.4	55	66.7	LMEU1509**ZNEN-MJ
TSN15R200M47.6-25-07	25	200	7	14	135	47.625	63	14	25.4	31.5	101.6	LMEU1509**ZNEN-MJ
TSN12R250M47.6-19-09	19	250	9	18	140	47.625	63	14	25.4	54	101.6	LMEU1208**ZNEN-MJ
TSN12R250M60.0E19-09	19	250	9	18	135	60	63	14	25.7	60	101.6	LMEU1208**ZNEN-MJ
TSN15R250M47.6-25-08	25	250	8	16	140	47.625	63	14	25.4	54	101.6	LMEU1509**ZNEN-MJ
TSN15R250M60.0E25-08	25	250	8	16	135	60	63	14	25.7	60	101.6	LMEU1509**ZNEN-MJ

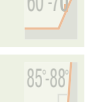
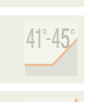

SPARE PARTS

Designation	Clamping screw	Grip	Torx bit
TSN10/12R...	SM40-143-H0	H-TB	BT15S
TSN15R...	CSTB-5L159	H-TB	BT20S

Recommended clamping torque: SM40-143-H0 = 3.5 N·m, CSTB-5L159 = 5 N·m

INSERT

LMEU-MJ

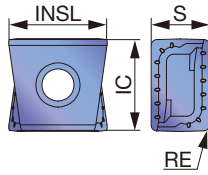

P Steel	☆	☆	★
M Stainless		☆	★
K Cast iron	★	☆	
N Non-ferrous			
S Superalloys	★	★	
H Hard materials			

★ : First choice
☆ : Second choice

Designation	RE	Coated				INSL	IC	S
		AH120	AH140	AH725	AH3135			
LMEU100808ZNEN-MJ	0.8	●	●	●	●	12.7	10.5	8
LMEU100810ZNEN-MJ	1	●			●	12.7	10.5	8
LMEU100816ZNEN-MJ	1.6	●	●	●	●	12.5	10.5	8
LMEU100820ZNEN-MJ	2	●			●	12.4	10.5	8
LMEU100824ZNEN-MJ	2.4	●	●	●	●	12.4	10.5	8
LMEU100830ZNEN-MJ	3	●			●	12.2	10.5	8
LMEU100832ZNEN-MJ	3.2	●	●	●	●	12.2	10.5	8
LMEU120808ZNEN-MJ	0.8	●	●	●	●	13.6	12.7	8
LMEU120816ZNEN-MJ	1.6	●	●	●	●	13.4	12.7	8
LMEU120820ZNEN-MJ	2	●			●	13.3	12.7	8
LMEU120824ZNEN-MJ	2.4	●	●	●	●	13.2	12.7	8
LMEU120830ZNEN-MJ	3	●			●	13.1	12.7	8
LMEU120832ZNEN-MJ	3.2	●	●	●	●	13.1	12.7	8
LMEU150908ZNEN-MJ	0.8	●	●	●	●	15.6	15	9.5
LMEU150916ZNEN-MJ	1.6	●	●	●	●	15.4	15	9.5
LMEU150920ZNEN-MJ	2	●			●	15.4	15	9.5
LMEU150924ZNEN-MJ	2.4	●	●	●	●	15.3	15	9.5
LMEU150930ZNEN-MJ	3	●			●	15.2	15	9.5
LMEU150932ZNEN-MJ	3.2	●	●	●	●	15.1	15	9.5
LMEU150940ZNEN-MJ*	4	●			●	14.9	15	9.5
LMEU150950ZNEN-MJ*	5	●			●	14.7	15	9.5

* Please note that LMEU150940 and LMEU150950 inserts are for special cutter bodies only and do not fit standard versions.

● : Line up

STANDARD CUTTING CONDITIONS

ISO	Workpiece material	Hardness	Priority	Grade	Cutting speed Vc (m/min)	Feed per edge line: fz (mm/t)			
						TSN / ASN			
						10%	20%	30%	≤ 50%
P	Low carbon steels S450, etc. E275A, etc.	- 200 HB	First choice	AH3135	90 - 180	0.22 - 0.42	0.16 - 0.31	0.14 - 0.27	0.13 - 0.25
			Fracture resistance	AH725	90 - 180	0.22 - 0.42	0.16 - 0.31	0.14 - 0.27	0.13 - 0.25
	High carbon steels S45C, etc. C45, etc.	200 - 300 HB	First choice	AH3135	90 - 180	0.22 - 0.42	0.16 - 0.31	0.14 - 0.27	0.13 - 0.25
			Fracture resistance	AH725	90 - 180	0.22 - 0.42	0.16 - 0.31	0.14 - 0.27	0.13 - 0.25
	Alloy steels SCM440, etc. 42CrMo4, etc.	150 - 300 HB	First choice	AH3135	90 - 180	0.22 - 0.42	0.16 - 0.31	0.14 - 0.27	0.13 - 0.25
			Fracture resistance	AH725	90 - 180	0.22 - 0.42	0.16 - 0.31	0.14 - 0.27	0.13 - 0.25
Tool steels SKD61, etc. X40CrMoV5-1, etc.	- 300 HB	First choice	AH3135	90 - 180	0.22 - 0.42	0.16 - 0.31	0.14 - 0.27	0.13 - 0.25	
		Fracture resistance	AH725	90 - 180	0.22 - 0.42	0.16 - 0.31	0.14 - 0.27	0.13 - 0.25	
M	Stainless steel SUS304, etc. X5CrNi18-9, etc.	- 200 HB	-	AH3135	90 - 200	0.22 - 0.42	0.16 - 0.31	0.14 - 0.27	0.13 - 0.25
K	Grey cast irons FC250, etc. 250, etc.	150 - 250 HB	-	AH120	120 - 230	0.22 - 0.5	0.16 - 0.38	0.14 - 0.32	0.13 - 0.3
	Ductile cast irons FCD400, etc. 400-15S, etc.	150 - 250 HB	-	AH120	90 - 150	0.22 - 0.33	0.16 - 0.25	0.14 - 0.21	0.13 - 0.2
S	Titanium alloys Ti-6Al-4V, etc.	- 40 HRC	First choice	AH725	30 - 40	0.12 - 0.22	0.09 - 0.16	0.07 - 0.14	0.07 - 0.13
	Nickel-based alloys Inconel 718, etc.	- 40 HRC	First choice	AH725	20 - 35	0.12 - 0.22	0.09 - 0.16	0.07 - 0.14	0.07 - 0.13



ADD^{FORCE}BARREL



Barrel-shaped inserts for profile milling with productivity boost!

Large R cutting edge and multi-flute design for unparalleled productivity



Large R for small cusp height



Close pitch design

ADD^{FORCE}BARREL
DCX = 20 mm, PRFRAD = 30 mm



Large pitch

Cusp height

Ball endmill
DCX = 20 mm, R = 10 mm



Small pitch

Cusp height

AddForceBarrel reduces the number of passes by 40% compared to ball endmill with 10 mm radius without compromising the surface quality (cusp height).

Excellent clamping reliability with dove-tail back support

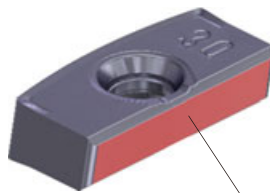

Wide contact surface

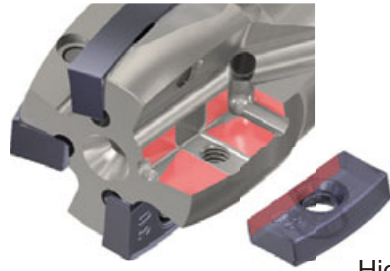

High clamping rigidity



Dove-tail clamping

Reference pages: **H198 - H199**

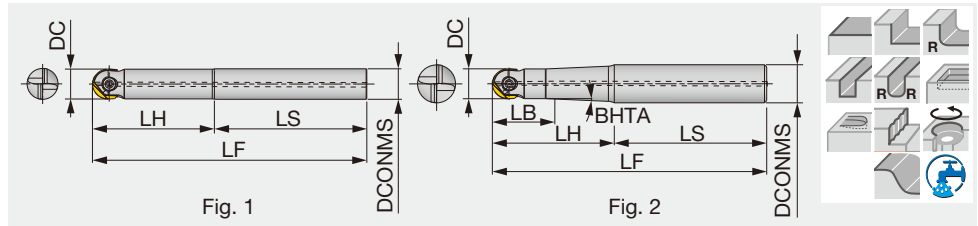

Designation	DC	DCONMS	LS	LH	LF	LB	BHTA	Air hole	Fig.	Shank material	Insert
EBFM08T12S100	8	12	80	20	100	10	9.5°	With	2	Steel	ZFBM080...
EBFM08S08C100	8	8	70	30	100	-	-	Without	1	Carbide	ZFBM080...
EBFM08S08C140	8	8	75	65	140	-	-	Without	1	Carbide	ZFBM080...
EBFM10T12S100	10	12	75	25	100	15	5°	With	2	Steel	ZFBM100...
EBFM10S10C140	10	10	65	75	140	-	-	Without	1	Carbide	ZFBM100...
EBFM10S10C220	10	10	80	140	220	-	-	Without	1	Carbide	ZFBM100...
EBFM12S12S110	12	12	80	30	110	-	-	With	1	Steel	ZF*M120..., ZFCBM120...
EBFM12S12C160	12	12	70	90	160	-	-	Without	1	Carbide	ZF*M120..., ZFCBM120...
EBFM12S12C220	12	12	70	150	220	-	-	Without	1	Carbide	ZF*M120..., ZFCBM120...
EBFM16T20S130	16	20	80	50	130	15.5	1.5°	With	2	Steel	ZF*M160..., ZFCBM160...
EBFM16S16C160	16	16	80	80	160	-	-	Without	1	Carbide	ZF*M160..., ZFCBM160...
EBFM16S16C220	16	16	70	150	220	-	-	Without	1	Carbide	ZF*M160..., ZFCBM160...
EBFM20T25S180	20	25	100	80	180	24	2.5°	With	2	Steel	ZF*M200..., ZFCBM200...
EBFM20S20C220	20	20	100	120	220	-	-	Without	1	Carbide	ZF*M200..., ZFCBM200...
EBFM20S20C300	20	20	80	220	300	-	-	Without	1	Carbide	ZF*M200..., ZFCBM200...
EBFM25T32S200	25	32	100	100	200	32	1.5°	With	2	Steel	ZFBM250..., ZFCBM250...
EBFM25S25C220	25	25	100	120	220	-	-	Without	1	Carbide	ZFBM250..., ZFCBM250...
EBFM25S25C300	25	25	80	220	300	-	-	Without	1	Carbide	ZFBM250..., ZFCBM250...
EBFM30T32S220	30	32	120	100	220	35	0.5°	With	2	Steel	ZFBM300..., ZFCBM300...
EBFM30S32C250	30	32	100	150	250	-	-	Without	1	Carbide	ZFBM300..., ZFCBM300...
EBFM30S32C350	30	32	100	250	350	-	-	Without	1	Carbide	ZFBM300..., ZFCBM300...
EBFM32S32S250	32	32	150	100	250	-	-	With	1	Steel	ZFBM320...
EBFM32S32C300	32	32	80	220	300	-	-	Without	1	Carbide	ZFBM320...

SPARE PARTS

Designation	Clamping screw	Torx bit	Grip	Wrench
EBFM08...	TS 25F080A	-	-	T-8D
EBFM10...	TS 30F100A	-	-	T-10D
EBFM12...	TS 40F120A	-	-	T-15D
EBFM16...	TS 50F160A	BT20S	H-TB2W	-
EBFM20...	TS 60F200A	BLDT25/M7	H-TB2W	-
EBFM25...	TS 70F250A	BLDT25/M7	H-TB2W	-
EBFM30...	TS 80F300A	-	-	T-T30
EBFM32...	TS 80F300A	-	-	T-T30

Recommended clamping torque: TS 25F080A = 1.3 N-m, TS 30F100A = 2.5 N-m, TS 40F120A = 3.5 N-m, TS 50F160A = 5 N-m, TS 60F200A, TS 70F250A = 7 N-m, TS 80F300A = 10 N-m





BALLFINISH HBFM

High precision finishing endmill, modular type (TungFlex), with screw clamp system

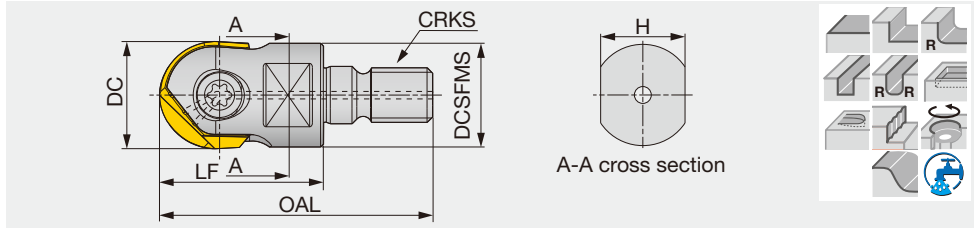

Designation	DC	OAL	LF	H	DCSFMS	CRKS	Air hole	Insert
HBFM10M06	10	34.5	20	7	9.7	M6	With	ZFBM100...
HBFM12M06	12	37.5	23	7	11.5	M6	With	ZF*M120..., ZFCBM120...
HBFM12M08	12	40	23	10	13	M8	With	ZF*M120..., ZFCBM120...
HBFM16M08	16	47	30	10	13	M8	With	ZF*M160..., ZFCBM160...
HBFM20M10	20	49	30	15	19	M10	With	ZF*M200..., ZFCBM200...
HBFM25M12	25	57	35	17	24	M12	With	ZFBM250..., ZFCBM250...
HBFM30M16	30	66	43	22	29	M16	With	ZFBM300..., ZFCBM300...
HBFM32M16	32	66	43	22	29.5	M16	With	ZFBM320...

SPARE PARTS

Designation	Clamping screw	Torx bit	Grip	Wrench
HBFM10...	TS 30F100A	-	-	T-10D
HBFM12...	TS 40F120A	-	-	T-15D
HBFM16...	TS 50F160A	BT20S	H-TB2W	-
HBFM20...	TS 60F200A	BLDT25/M7	H-TB2W	-
HBFM25...	TS 70F250A	BLDT25/M7	H-TB2W	-
HBFM30..., HBFM32...	TS 80F300A	-	-	T-T30

Recommended clamping torque :

TS 25F080A = 1.3 N·m, TS 30F100A = 2.5 N·m,

TS 40F120A = 3.5 N·m, TS 50F160A = 5 N·m,

TS 60F200A, TS 70F250A = 7 N·m, TS 80F300A = 10 N·m

Approach angle

7°-25°

41°-45°

60°-70°

85°-88°

90°

Others

Reference pages: TungFlex → **H036 - H037**

INSERT

ZFBM-MJ

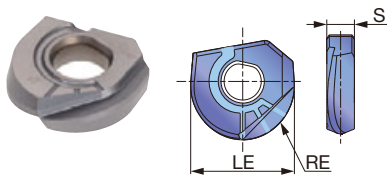

ZFRM-MJ

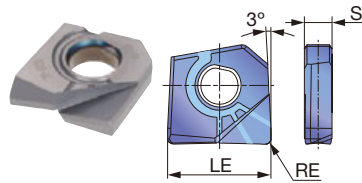

ZFCBM-MM

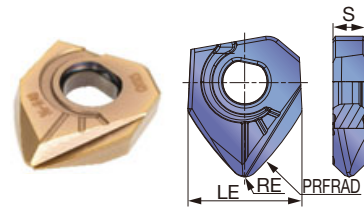

P	Steel	★	☆	★
M	Stainless	★		☆
K	Cast iron	★	★	☆
N	Non-ferrous	☆		☆
S	Superalloys	★		★
H	Hard materials	★	★	☆

★ : First choice
☆ : Second choice

Designation	PRFRAD	RE	Coated			LE	S
			CH315	AH710	AH725		
ZFBM080R00-MJ	-	4	●	●		8	2.4
ZFBM100R00-MJ	-	5	●	●		10	2.9
ZFBM120R00-MJ	-	6	●	●		12	3.4
ZFBM160R00-MJ	-	8	●	●		16	4.4
ZFBM200R00-MJ	-	10	●	●		20	5.4
ZFBM250R00-MJ	-	12.5	●	●		25	6.4
ZFBM300R00-MJ	-	15	●	●		30	7.4
ZFBM320R00-MJ	-	16	●	●		32	7.4
ZFRM120R05-MJ	-	0.5	●	●		12	3.4
ZFRM120R10-MJ	-	1	●	●		12	3.4
ZFRM160R05-MJ	-	0.5	●	●		16	4.4
ZFRM160R10-MJ	-	1	●	●		16	4.4
ZFRM160R15-MJ	-	1.5	●	●		16	4.4
ZFRM200R10-MJ	-	1	●	●		20	5.4
ZFRM200R15-MJ	-	1.5	●	●		20	5.4
ZFCBM120R300-MM	30	1.5	●			12	3.4
ZFCBM160R400-MM	40	2	●			16	4.4
ZFCBM200R500-MM	50	2.5	●			20	5.4
ZFCBM250R625-MM	62.5	3	●			25	6.4
ZFCBM300R750-MM	75	3.5	●			30	7.4

With ZFCBM insert, the functional length (LF) of the EBFM and HBFM cutters becomes longer for the amount as indicated below: ● : Line up

For E/HBFM12, +2.6 mm; E/HBFM16, +4 mm; E/HBFM20, +4.4 mm; E/HBFM25, +5.8 mm; and E/HBFM30, +5.9 mm.

ZFBM080/100/120/160... : 5 piece per package, ZFBM200/250/300/320... : 1 piece per package

ZFRM120/160... : 5 piece per package, ZFRM200... : 1 piece per package



STANDARD CUTTING CONDITIONS

ZF*M-MJ



ISO	Workpiece materials	Hardness	Priority	Grades	Max. depth of cut (mm)	Cutting speed Vc (m/min)	Feed per tooth: fz (mm/t)							
							D8	D10	D12	D16	D20	D25	D30	D32
P	Low carbon steel, alloy steel	85 - 180 HB	First choice	AH725	≤ 0.04D	180 - 260	0.15	0.2	0.2	0.25	0.25	0.3	0.35	0.35
		85 - 180 HB	Wear resistance	AH710	≤ 0.04D	180 - 260	0.15	0.2	0.2	0.25	0.25	0.3	0.35	0.35
	High carbon steel, alloy steel	180 - 280 HB	First choice	AH725	≤ 0.03D	150 - 230	0.15	0.2	0.2	0.25	0.25	0.3	0.35	0.35
		180 - 280 HB	Wear resistance	AH710	≤ 0.03D	180 - 230	0.15	0.2	0.2	0.25	0.25	0.3	0.35	0.35
	Prehardened steel Die & mold tool steel	40 - 48 HRC	First choice	AH710	≤ 0.03D	180 - 300	0.15	0.15	0.2	0.2	0.25	0.25	0.3	0.3
		40 - 48 HRC	Fracture resistance	AH725	≤ 0.03D	180 - 300	0.15	0.15	0.2	0.2	0.25	0.25	0.3	0.3
M	Stainless steel	135 - 200 HB	First choice	AH725	≤ 0.03D	100 - 250	0.1	0.15	0.2	0.2	0.25	0.25	0.3	0.3
K	Cast iron	150 - 240 HB	First choice	AH710	≤ 0.04D	90 - 350	0.2	0.2	0.25	0.3	0.3	0.35	0.4	0.4
		150 - 240 HB	Fracture resistance	AH725	≤ 0.04D	90 - 350	0.2	0.2	0.25	0.3	0.3	0.35	0.4	0.4
N	Aluminium	-	First choice	AH725	≤ 0.03D	200 - 400	0.25	0.25	0.35	0.35	0.35	0.4	0.4	0.45
S	Titanium alloy	- 40 HRC	First choice	AH725	≤ 0.03D	30 - 80	0.08	0.08	0.1	0.12	0.15	0.18	0.2	0.2
	Heat-resistance alloys	- 40 HRC	First choice	AH725	≤ 0.03D	20 - 60	0.08	0.08	0.1	0.12	0.15	0.18	0.2	0.2
H	High hardened steel	48 - 65 HRC	First choice	AH710	≤ 0.02D	50 - 180	0.08	0.08	0.1	0.13	0.15	0.2	0.2	0.25

- Remove excessive chip accumulation with an air blast.
- For the operation with depth of cut which varies (ex.casting skin) and machining of workpiece materials with interrupted surface, the feed per tooth (fz) should be set to the lower recommended value shown in the above table.
- Cutting conditions maybe limited depending on machine power, workpiece rigidity, and spindle output. When the cutting width, depth, or overhang length is large, set Vc and fz to the lower recommended values and check the machine power and vibration.

How to clamp the insert

1. Clear chips and dust from the pocket.
2. Place the insert in the pocket. The insert can be placed only in one direction.
3. Tighten the screw while pressing the insert into the pocket.

How to check the run-out

1. Clamp the insert on the shank.
 2. Clamp the shank on a high-precision arbor.
 3. Measure the run-out on tool presetter or by dial gauge.
- Notes:
1. Due to the helical cutting edge, it is important that the run-out is inspected with the insert clamped on the shank.
 2. Do not use micrometer or caliper to inspect the insert diameter as inaccurate dimensions may be provided.

STANDARD CUTTING CONDITIONS

ZFCBM-MM

ISO	Workpiece materials	Hardness	Cutting speed Vc (m/min)	Feed per tooth fz (mm/t)	Width of cut ae (mm)
P	Low carbon steel S15C, SS400, etc. C15E4, E275A, etc.	- 200HB	100 - 600	0.05 - 0.3	< 0.3
	Carbon steel S45C, S55C, etc. C45, C55, etc.	- 300HB	100 - 600	0.05 - 0.3	< 0.3
	Prehardened steel NAK80, PX5, etc.	30 - 40HRC	100 - 600	0.05 - 0.3	< 0.3
M	Austenitic stainless steel SUS304, SUS316, etc. X5CrNi18-9, X5CrNiMo17-12-2, etc.	- 200HB	100 - 600	0.05 - 0.3	< 0.3
	Precipitation hardening stainless steel SUS630, etc. X5CrNiCuNb16-4, etc.	- 45HRC	100 - 300	0.05 - 0.25	< 0.2
K	Grey cast iron FC250, FC300, etc. 250, 300, etc.	150 - 250HB	100 - 600	0.05 - 0.3	< 0.3
	Ductile cast iron FCD400, etc. 400-15, 600-3, etc.	150 - 250HB	100 - 600	0.05 - 0.3	< 0.3
S	Titanium alloys Ti-6Al-4V, etc.	- 45HRC	40 - 120	0.05 - 0.2	< 0.2
	Superalloys Inconel718, etc.	- 45HRC	20 - 80	0.05 - 0.2	< 0.2
H	Hardened steel SKD61, etc. X40CrMoV5-1, etc.	40 - 55HRC	50 - 300	0.05 - 0.2	< 0.2

■ Cusp height and pitch

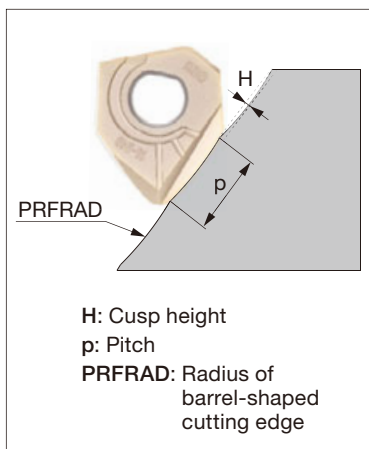

To obtain the pitch (p) from the given cusp height (H)

PRFRAD (mm)	H (mm)							
	0.001	0.002	0.003	0.004	0.005	0.01	0.015	0.02
30 (ZFCBM120R300...)	0.49	0.69	0.85	0.98	1.1	1.55	1.9	2.19
40 (ZFCBM160R400...)	0.57	0.8	0.98	1.13	1.26	1.79	2.19	2.53
50 (ZFCBM200R500...)	0.63	0.89	1.1	1.26	1.41	2	2.45	2.83
62.5 (ZFCBM250R625...)	0.71	1	1.22	1.41	1.58	2.24	2.74	3.16
75 (ZFCBM300R750...)	0.77	1.1	1.34	1.55	1.73	2.45	3	3.46

$$p = \sqrt{8 \times H \times \text{PRFRAD}}$$

(mm)

To obtain the cusp height (H) from the given pitch (p)

PRFRAD (mm)	p (mm)						
	0.5	0.75	1	1.25	1.5	1.75	2
30 (ZFCBM120R300...)	0.001	0.002	0.004	0.007	0.009	0.013	0.017
40 (ZFCBM160R400...)	0.001	0.002	0.003	0.005	0.007	0.01	0.013
50 (ZFCBM200R500...)	0.001	0.001	0.003	0.004	0.006	0.008	0.01
62.5 (ZFCBM250R625...)	0.001	0.001	0.002	0.003	0.005	0.006	0.008
75 (ZFCBM300R750...)	< 0.001	0.001	0.002	0.003	0.004	0.005	0.007

$$H = \frac{p^2}{8 \times \text{PRFRAD}}$$

(mm)



Profiling endmill, modular type (TungFlex)

GAMP = +7.1° ~ +9.2°, GAMF = -20.8° ~ -17.9°



with ZNHU1003R30-MM

with ZNHU1003R20-MM

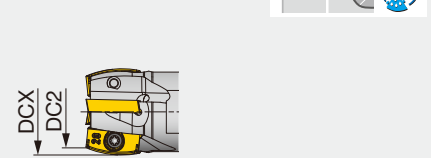
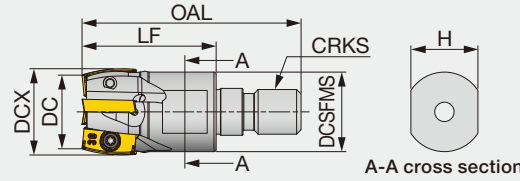

Designation	DCX	CICT	DC	DC2	OAL	LF	DCSFMS	CRKS	H	WT(kg)	Air hole	Insert
HFZN10M016M08R03	16	3	13	12.5	42	25	14.5	M8	10	0.02	With	ZNHU1003...
HFZN10M020M10R04	20	4	17	16.5	49	30	17.8	M10	15	0.05	With	ZNHU1003...
HFZN10M025M12R05	25	5	22	21.5	57	35	23	M12	17	0.1	With	ZNHU1003...
HFZN10M035M16R07	35	7	31.9	31.4	63	40	28.8	M16	22	0.22	With	ZNHU1003...
HFZN10M040M16R08	40	8	36.9	36.4	63	40	28.8	M16	22	0.25	With	ZNHU1003...

SPARE PARTS

Designation	Clamping screw	Wrench
HFZN10...	SR-M2.5X0.45-L6IP7	IP-7D

Recommended clamping torque: 1 N·m

INSERTS

ZNHU1003R20-MM

ZNHU1003R30-MM

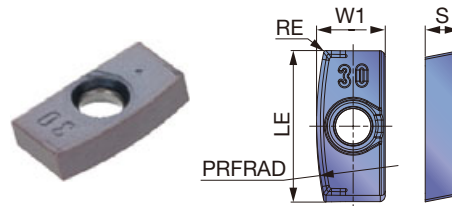
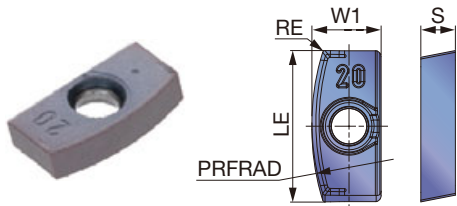

Material	Steel	Stainless	Cast iron	Non-ferrous	Superalloy	Hard materials
★	★	★	★	★	★	☆

★ : First choice
☆ : Second choice

Designation	PRFRAD	RE	Coated							LE	W1	S
			AH9130									
ZNHU1003R20-MM	20	0.2	●							11.5	5.61	2.8
ZNHU1003R30-MM	30	0.2	●							11.5	5.56	2.8

● : Line up

STANDARD CUTTING CONDITIONS

ISO	Workpiece materials	Hardness	Cutting speed Vc (m/min)	Feed per tooth fz (mm/t)	Width of cut ae (mm)
P	Low carbon steel S15C, SS400, etc. C15E4, E275A, etc.	- 200 HB	100 - 600	0.05 - 0.3	< 0.4
	Carbon steel S45C, S55C, etc. C45, C55, etc.	- 300 HB	100 - 600	0.05 - 0.3	< 0.3
	Prehardened steel NAK80, PX5, etc.	30 - 40 HRC	100 - 600	0.05 - 0.3	< 0.3
M	Austenitic stainless steel SUS304, SUS316, etc. X5CrNi18-9, X5CrNiMo17-12-2, etc.	- 200 HB	100 - 500	0.05 - 0.3	< 0.3
	Precipitation hardening stainless steel SUS630, etc. X5CrNiCuNb16-4, etc.	- 45 HRC	100 - 300	0.05 - 0.25	< 0.2
K	Grey cast iron FC250, FC300, etc. 250, 300, etc.	150 - 250 HB	100 - 600	0.05 - 0.3	< 0.3
	Ductile cast iron FCD400, etc. 400-15, 600-3, etc.	150 - 250 HB	100 - 600	0.05 - 0.3	< 0.3
S	Titanium alloys Ti-6Al-4V, etc.	- 45 HRC	40 - 120	0.05 - 0.2	< 0.2
	Superalloys Inconel718, etc.	- 45 HRC	20 - 80	0.05 - 0.2	< 0.2
H	Hardened steel SKD61, etc. X40CrMoV5-1, etc.	40 - 55 HRC	50 - 300	0.05 - 0.2	< 0.2

■ Cusp height and pitch

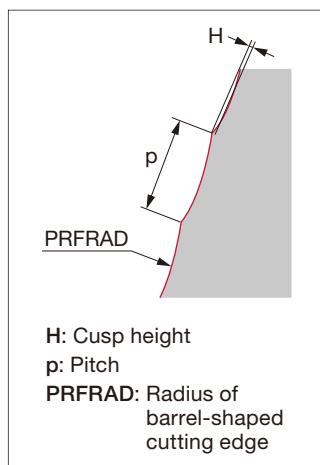

To obtain the pitch (p) from the given cusp height (H)

H (mm)	0.001	0.002	0.003	0.004	0.005	0.01	0.015	0.02
PRFRAD (mm)								
20 (ZNHU1003R20...)	0.4	0.57	0.69	0.8	0.89	1.26	1.55	1.79
30 (ZNHU1003R30...)	0.49	0.69	0.85	0.98	1.1	1.55	1.9	2.19

$$p = \sqrt{8 \times H \times \text{PRFRAD}}$$

(mm)

To obtain the cusp height (H) from the given pitch (p)

p (mm)	0.5	0.75	1	1.25	1.5	1.75	2
PRFRAD (mm)							
20 (ZNHU1003R20...)	0.002	0.004	0.006	0.01	0.014	0.019	0.025
30 (ZNHU1003R30...)	0.001	0.002	0.004	0.007	0.009	0.013	0.017

$$H = \frac{p^2}{8 \times \text{PRFRAD}}$$

(mm)





Small-radius finishing endmill, modular type (TungFlex)

GAMP = 0°, GAMF = -14°

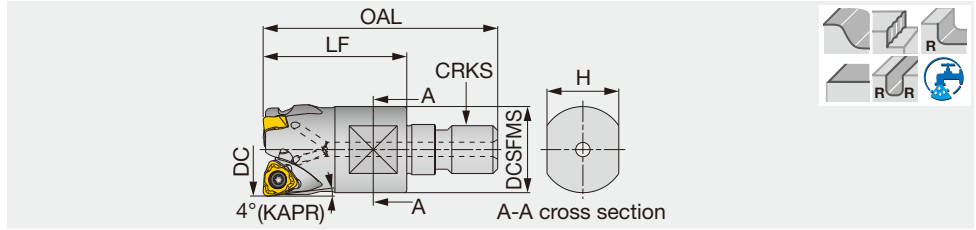

Designation	DC	CICT	OAL	LF	H	DCSFMS	CRKS	WT(kg)	Air hole	Insert
HFWX04M016M08R02	16	2	42	25	10	13	M8	0.03	With	WXHU04...
HFWX04M020M10R03	20	3	49	30	15	18	M10	0.05	With	WXHU04...
HFWX04M025M12R04	25	4	52	30	17	21	M12	0.09	With	WXHU04...

SPARE PARTS

Designation	Clamping screw	Lubricant	Wrench
HFWX04M...	SR34-514	M-1000	T-7F

Recommended clamping torque: 0.9 N·m

INSERT

WXHU-MJ

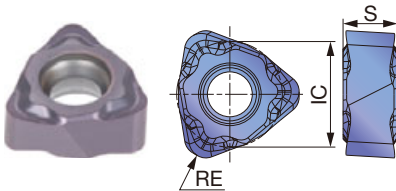

P Steel	★	
M Stainless		
K Cast iron		
N Non-ferrous		
S Superalloys		
H Hard materials	★	

★ : First choice
☆ : Second choice

Designation	RE	APMX	Coated		IC	S
			AH110			
WXHU040305R-MJ	0.5	0.5	●		6.35	3.18
WXHU040310R-MJ	1	1	●		6.35	3.18

* For plunging, the maximum cutting width is 2 mm.

●: Line up

STANDARD CUTTING CONDITIONS

ISO	Workpiece material	Hardness	Grade	Cutting speed Vc (m/min)	Feed per tooth fz (mm/t)
P	High carbon steel S45C, S55C, etc. C45, C55, etc. Alloy steel	200 - 300 HB	AH110	100 - 300	0.1 - 0.3
	SCM440, etc. 42CrMo4, SCr145, etc.	150 - 300 HB	AH110	100 - 300	0.1 - 0.3
	Prehardened steel NAK80, PX5, etc.	30 - 40 HRC	AH110	100 - 300	0.05 - 0.3
H	Hardened steel	SKD61, etc. X40CrMoV5-1, etc.	AH110	80 - 130	0.1 - 0.3
		SKD11, etc. X153CrMoV12, etc.	AH110	50 - 100	0.05 - 0.15

Reference pages: TungFlex → **H036 - H037**

Ball nose endmill for semi-roughing, shank type, with screw clamp system

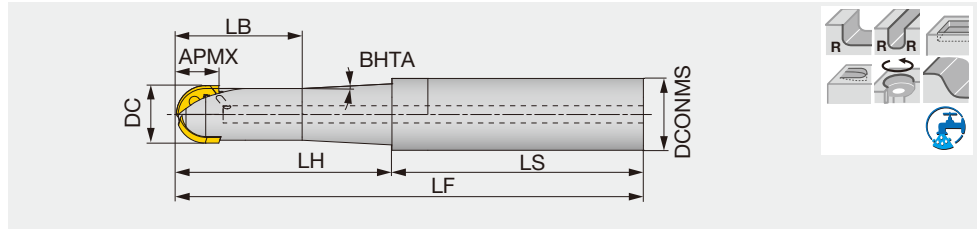

Designation	APMX	DC	CICT	DCONMS	LS	LF	LH	LB	BHTA	WT(kg)	Air hole	Insert
EBRM16T20S130	11.8	16	2	20	70	130	60	35	3	0.235	With	ZRBM160...
EBRM16T20S200	11.8	16	2	20	140	200	60	35	3	0.395	With	ZRBM160...
EBRM20T25S160	13.6	20	2	25	85	160	75	45	3	0.455	With	ZRBM200...
EBRM20T25S220	13.6	20	2	25	135	220	85	60	5	0.655	With	ZRBM200...
EBRM25T32S200	17.7	25	2	32	115	200	85	55	6	0.965	With	ZRBM250...
EBRM25T32S300	17.7	25	2	32	180	300	120	70	4	1.505	With	ZRBM250...

HBRM...

Ball nose endmill for semi-roughing, modular type (TungFlex), with screw clamp system

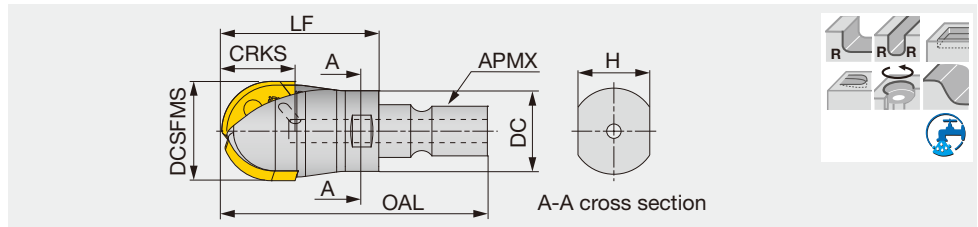

Designation	APMX	DC	CICT	OAL	LF	H	DCSFMS	CRKS	WT(kg)	Air hole	Insert
HBRM16M08	11.8	16	2	42.5	25	10	13	M8	0.025	With	ZRBM160...
HBRM20M10	13.6	20	2	50	30	15	18	M10	0.05	With	ZRBM200...
HBRM25M12	17.7	25	2	57	35	17	21	M12	0.08	With	ZRBM250...

SPARE PARTS



Designation	Clamping screw	Wrench
EBRM16..., HBRM16...	TS25064I	T-8D
EBRM20..., HBRM20...	TS30085I/HG	T-9D
EBRM25..., HBRM25...	TS35085I/HG	T-15D

Recommended clamping torque: TS25064I = 1.3 N·m, TS30085I/HG = 2.3 N·m, TS35085I/HG = 3.5 N·m



INSERT

ZRBM...

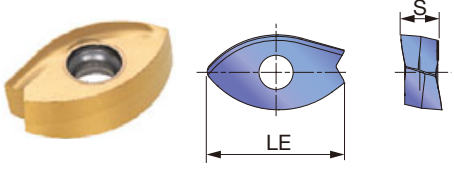

P Steel	★																			
M Stainless	☆																			
K Cast iron	☆																			
N Non-ferrous																				
S Superalloys	☆																			
H Hard materials	☆																			

★ : First choice
☆ : Second choice

Designation	RE	Coated										LE	S	
		APH730												
ZRBM160-MM	8	●											12.4	3.7
ZRBM200-MM	10	●											14.9	4.8
ZRBM250-MM	12.5	●											18.9	5.9

● : Line up
5 piece per package

STANDARD CUTTING CONDITIONS

ISO	Workpiece materials	Hardness	Selection criteria	Recommended grade	Chip-breaker	Cutting speed Vc (m/min)	Feed per tooth fz (mm/t)
P	Low carbon steel S15C, etc. C15, etc.	- 300HB	First choice	APH730	MM	150 - 350	0.08 - 0.6
	High carbon and alloy steel S55C, SCM440, etc. C55, 42CrMo4, etc.	- 300HB	First choice	APH730	MM	120 - 320	0.05 - 0.5
	Prehardened steels NAK80, PX5 etc.	30 - 40HRC	First choice	APH730	MM	100 - 200	0.05 - 0.5
M	Austenitic stainless steel SUS304, SUS316, etc. X5CrNi18-9, X5CrNiMo17-12-3, etc.	- 200HB	First choice	APH730	MM	100 - 280	0.05 - 0.6
	Martensitic stainless steel SUS420J1, etc. X20Cr13, etc.	- 200HB	First choice	APH730	MM	100 - 300	0.05 - 0.6
K	Gray cast irons FC250, etc. 250, etc.	150 - 250HB	First choice	APH730	MM	120 - 380	0.08 - 0.6
	Ductile cast iron FCD600, etc. 600-3, etc.	150 - 250HB	First choice	APH730	MM	100 - 280	0.08 - 0.6
S	Titanium alloy Ti-6Al-4V, etc.	- 40HRC	First choice	APH730	MM	20 - 80	0.05 - 0.6
	Heat-resistance alloys Inconel718, etc.	- 40HRC	First choice	APH730	MM	20 - 60	0.05 - 0.4
H	Hardened steel SKD61, etc. X40CrMoV51, etc.	40 - 50HRC	First choice	APH730	MM	40 - 80	0.05 - 0.2
	Hardened steel SKD11, etc. X153CrMoV12, etc.	50 - 60HRC	First choice	APH730	MM	30 - 60	0.04 - 0.14

The above cutting parameters are for reference. Adjustments may be required depending on applications, machine powers and rigidity, and/or workpiece fixture/clamping methods.

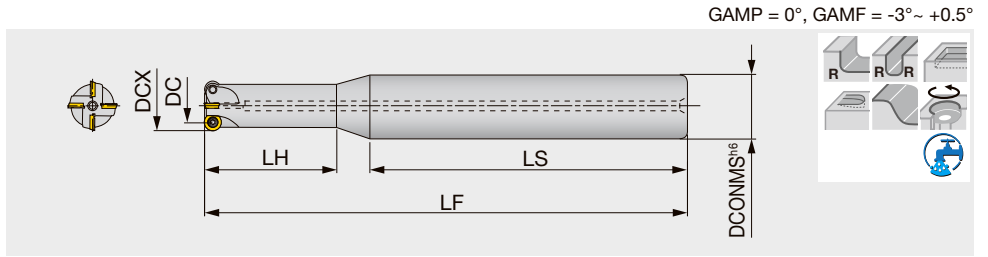

Designation	APMX	DC	CICT	DCX	DCONMS	LS	LH	LF	Air hole	Insert
EWD05010R	2.5	5	2	10	20	80	20	130	With	RDMW05...
EWD05012R	2.5	7	3	12	20	80	20	130	With	RDMW05...
EWD07015R	3.5	8	3	15	20	100	40	150	With	RDMW07...
EWD05015R	2.5	10	4	15	20	100	40	150	With	RDMW05...
EWD10020R	5.0	10	2	20	25	120	40	170	With	RDMW10...
EWD07020R	3.5	13	4	20	25	120	40	170	With	RDMW07...
EWD05020R	2.5	15	5	20	25	120	40	170	With	RDMW05...
EWD10025R	5.0	15	3	25	32	125	45	195	With	RDMW10...
EWD07025R	3.5	18	5	25	32	125	45	195	With	RDMW07...

HWD07-M

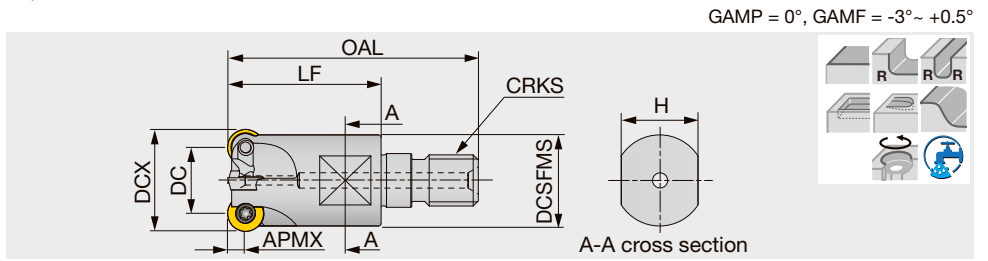

Designation	APMX	DC	CICT	DCX	OAL	LF	H	DCSFMS	CRKS	WT(kg)	Air hole
HWD07R015MM08-03	3.5	8	3	15	42	25	10	12.8	M8	0.03	With
HWD07R020MM10-04	3.5	13	4	20	49	30	15	17.8	M10	0.06	With
HWD07R025MM12-05	3.5	18	5	25	57	35	17	20.8	M12	0.1	With
HWD07R030MM16-05	3.5	23	5	30	63	40	22	28.8	M16	0.2	With

SPARE PARTS



Designation	Clamping screw	Lubricant	Wewnch
EWD050**R	CSTD-1.8	M-1000	T-6D
EWD070**R, HWD07**M...	CSTB-2.5S	M-1000	T-8D
EWD100**R	CSTB-3.5H	M-1000	T-15D

Recommended clamping torque: CSTD-1.8 = 0.7 N·m, CSTB-2.5S = 1.3 N·m, CSTB-3.5H = 3.5 N·m





INSERT

RDMW05/07/10

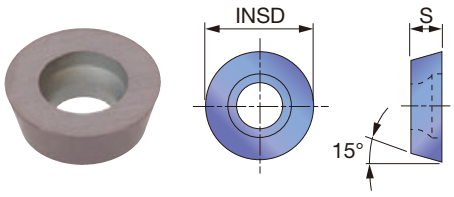

P	Steel	★								
M	Stainless									
K	Cast iron	★								
N	Non-ferrous									
S	Superalloys	★								
H	Hard materials									

★ : First choice
☆ : Second choice

Designation	APMX	Coated		INSD	S
		AH120			
RDMW0501M0	2.5	●		5	1.4
RDMW0702M0	3.5	●		7	2.38
RDMW1003M0	5.0	●		10	3.18

● : Line up

STANDARD CUTTING CONDITIONS

Please scan below.

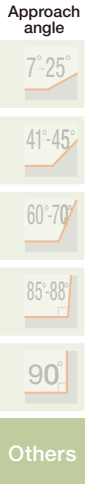
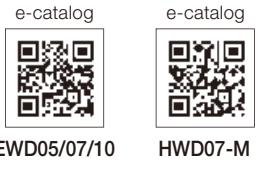

APPLICATION RANGE

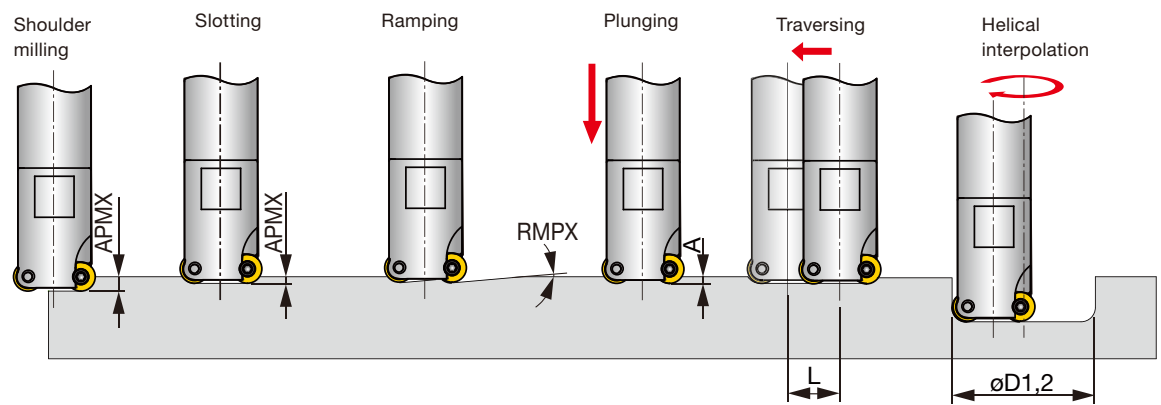

Designation	Tool-ø	Max. depth of cut	Max. ramping	Max. plunging depth	Machining length for removing uncut portion	Max. machining	*Max. machining
	DCX	APMX	RMPX	A	L	øD1	øD2
HWD07R015MM08-03	15	3.5	25°	2	øDc - 6	23	28
HWD07R020MM10-04	20	3.5	11°	2	øDc - 6	33	38
HWD07R025MM12-05	25	3.5	7°	2	øDc - 6	43	48
HWD07R030MM16-05	30	3.5	5.5°	2	øDc - 6	53	58

*For flat bottom hole

TBN1000

Ball nose endmill for semi-finishing

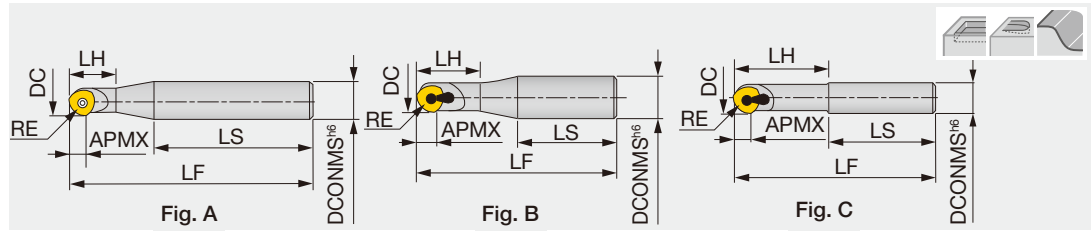

Designation	APMX	DC	CICT	DCONMS	LS	LH	LF	RE	Insert	Fig.
TBN1100S	5	10	1	16	60	15	90	5	ZNCA1002FN2	A
TBN1120S	6	12	1	16	70	20	110	6	ZNCA1203FN	A
TBN1160S	8	16	1	20	85	25	130	8	ZNCA1603FN	A
TBN1200S	10	20	1	25	100	35	160	10	ZN**2004...	A
TBN1250S	12.5	25	1	32	100	45	175	12.5	ZN**2505...	B
TBN1300S	15	30	1	32	100	90	190	15	ZN**3005...	C

SPARE PARTS

Designation	Clamping screw	Clamp	Adjusting screw	Wewnch
TBN1100S	CSTB-2.5B	-	-	T-8D
TBN1120S	CSTB-3S	-	-	T-9D
TBN1160S	CSTB-4S	-	-	T-15D
TBN1200S	CSTA-5SS	-	-	T-15D
TBN1250S, 1300S	CSTA-5S	CP536	DS-6T	T-15D

Recommended clamping torque: CSTB-2.5B = 1.3 N·m, CSTB-3S = 2.3 N·m, CSTB-4S/CSTA-5S/CSTA-5SS = 3.5 N·m

INSERT

ZNCA-FN

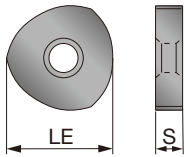

ZNCA-FN2

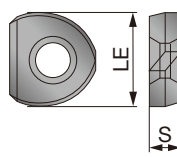

ZNMM-EN

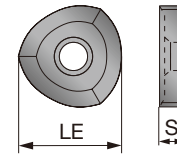

P Steel	★									
M Stainless										
K Cast iron		★								
N Non-ferrous										
S Superalloys										
H Hard materials										

★ : First choice
☆ : Second choice

Designation	Uncoated		LE	S
	UX30	TH10		
ZNCA1002FN2	●	●	7.958	2.5
ZNCA1203FN	●	●	9.735	3
ZNCA1603FN	●	●	12.772	3.5
ZNCA2004FN	●	●	15.862	4
ZNCA2505FN	●	●	19.826	5
ZNCA3005FN	●	●	23.618	5
ZNMM2004EN	●		15.862	4
ZNMM2505EN	●		19.826	5
ZNMM3005EN	●		23.618	5.5

● : Line up

STANDARD CUTTING CONDITIONS

Please scan below.

e-catalog



TBN1000



GUIDELINES FOR SELECTING DEPTH OF CUT AND FEED

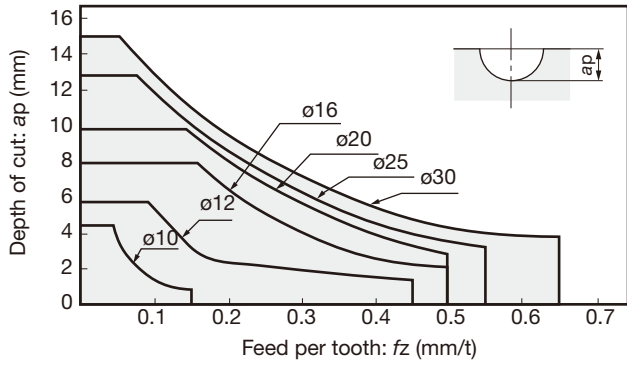

Workpiece material: Carbon steel (S55C, C55)
 Insert grade: UX30
 Machine power: ø10 - ø16: 7.5 kW
 ø20 - ø30: 22.5 kW
 No. of revolutions: ø10 - ø16: 2000 min⁻¹
 ø20 - ø30: 1500 min⁻¹

EBP

Ball nose endmill for semi-finishing

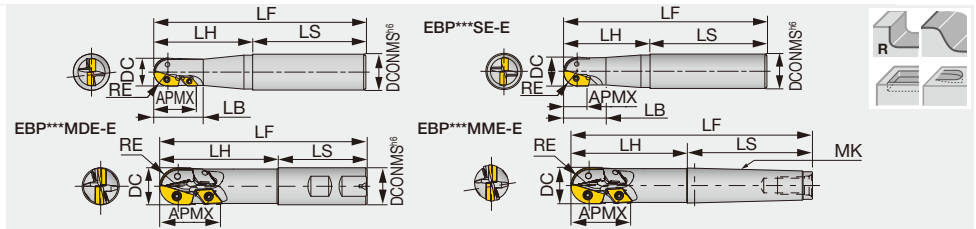

Designation	APMX	DC	CICT	DCONMS	LS	LH	LF	LB	RE	MK	Insert 1	Insert 2
EBP020SD-E	16	20	2	20	56	60	116	-	10	-	ZPET2004-MJ	-
EBP020SS	16	20	2	25	80	60	140	30	10	-	ZPET2004-MJ	-
EBP020MDE-E	29.5	20	2 (4)	20	56	70	126	-	10	-	ZPET2004-MJ	DCMW070204TN
EBP020MME-E	29.5	20	2 (4)	-	69	70	139	-	10	MK2	ZPET2004-MJ	DCMW070204TN
EBP020MSE	29.5	20	2 (4)	25	80	70	150	35	10	-	ZPET2004-MJ	DCMW070204TN
EBP020LSE	29.5	20	2 (4)	25	180	70	250	35	10	-	ZPET2004-MJ	DCMW070204TN
EBP025SD-E	21	25	2	25	60	70	130	-	12.5	-	ZPET2505-MJ	-
EBP025SS	21	25	2	32	80	70	150	35	12.5	-	ZPET2505-MJ	-
EBP025MDE-E	41	25	2 (4)	25	60	80	140	-	12.5	-	ZPET2505-MJ	DCMW11T304TN
EBP025MME-E	41	25	2 (4)	-	86	-	166	-	12.5	MK3	ZPET2505-MJ	DCMW11T304TN
EBP025MSE	41	25	2 (4)	32	100	80	180	50	12.5	-	ZPET2505-MJ	DCMW11T304TN
EBP025LSE	41	25	2 (4)	32	220	80	300	50	12.5	-	ZPET2505-MJ	DCMW11T304TN
EBP030SS	24	30	2	32	80	80	160	40	15	-	ZPET3006-MJ	-
EBP030MSE	45	30	2 (4)	32	100	100	200	55	15	-	ZPET3006-MJ	DCMW11T304TN
EBP030LSE	45	30	2 (4)	32	250	100	350	55	15	-	ZPET3006-MJ	DCMW11T304TN
EBP032SD-E	25	32	2	32	60	-	140	-	16	-	ZPET3206-MJ	-
EBP032MDE-E	46	32	2 (4)	32	60	100	160	-	16	-	ZPET3206-MJ	DCMW11T304TN
EBP032MME-E	46	32	2 (4)	-	109	100	209	-	16	MK4	ZPET3206-MJ	DCMW11T304TN

SPARE PARTS

Designation	Clamping screw for Insert 1	Clamping screw for Insert 2	Lubricant	Wewnch 1 for Insert 1	Wewnch 2 for Insert 2
EBP020SS/SD-E	CSTD-3T	-	M-1000	T-10D	-
EBP025SS/SD-E, EBP025*SE/M*E-E	CSTB-4S	-	M-1000	T-15D	-
EBP030SS/032SD-E	CSTB-5S	-	M-1000	T-20D	-
EBP020*SE/M*E-E	CSTB-2.5S	CSTD-3T	M-1000	T-10D	T-8D
EBP030*SE/032M*E-E	CSTB-4S	CSTB-5S	M-1000	T-15D	T-20D

Recommended clamping torque :
 CSTB-2.5S = 1.3 N·m, CSTD-3T = 2.5 N·m,
 CSTB-4S = 3.5 N·m, CSTB-5S = 5 N·m

Reference pages: Inserts → **H207**

INSERT

ZPET-MJ (For R edge)

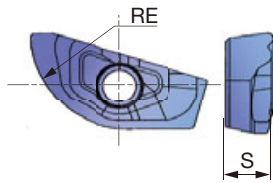

DCMW-TN (For P edge)

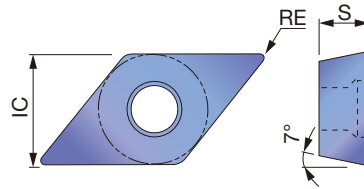

P	Steel	☆	★										
M	Stainless												
K	Cast iron		★										
N	Non-ferrous												
S	Superalloys												
H	Hard materials	☆											

★ : First choice
☆ : Second choice

Designation	RE	Coated										IC	S	
		AH120	AH330											
ZPET2004-MJ	10	●	●										-	4.5
ZPET2505-MJ	12.5	●	●										-	5.63
ZPET3006-MJ	15	●	●										-	6.75
DCMW070204TN	0.4	●	●										6.4	2.4
DCMW11T304TN	0.4	●	●										9.5	4

● : Line up
ZPET30... : 5 piece per package

STANDARD CUTTING CONDITIONS

Please scan below.

e-catalog



Machining types

(1) Grooving	(2) Shouldering at shallow depth of cut	(3) Shouldering at deep depth of cut

Grade
Insert
Ext. Toolholder
Int. Toolholder
Threading
Grooving
Miniature tool
Milling cutter
Endmill
Drilling tool
Tooling System
User's Guide
Index





EBB

Ball nose endmill for semi-finishing, for CBN inserts

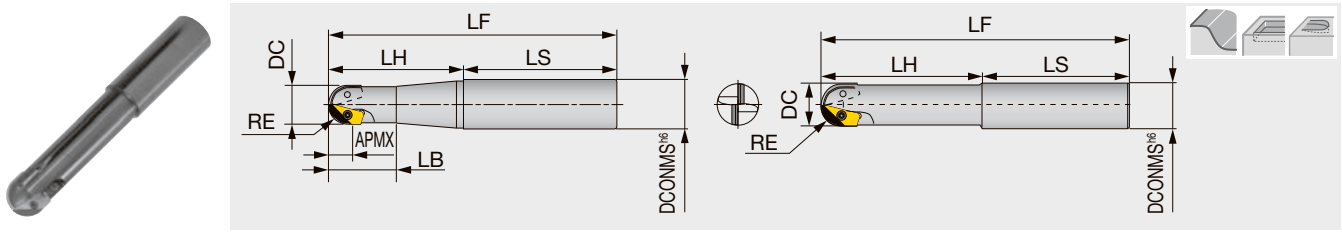

Designation	APMX	DC	CICT	DCONMS	LS	LH	LF	LB	RE	Insert
EBB020MS	12	20	2	25	80	70	150	35	10	ZPCW2003-QBN
EBB025MS	15.5	25	2	32	100	80	180	50	12.5	ZPCW25H3-QBN
EBB030MS	18	30	2	32	100	100	200	-	15	ZPCW30T3-QBN
EBB040MS	23	40	2	42	100	150	250	-	20	ZPCW4004-QBN
EBB050MS	28	50	2	50	100	150	250	-	25	ZPCW5004-QBN

SPARE PARTS

Designation	Clamping screw	Lubricant	Wrench	Clamp set
EBB020MS	CSTB-3S	M-1000	T-9D	-
EBB025MS	CSTB-3.5	M-1000	T-15D	-
EBB030MS	CSTB-4S	M-1000	T-15D	-
EBB040MS, EBB050MS	CSTB-5	M-1000	T-20D	CSP22

Recommended clamping torque: CSTB-3S = 2.3 N·m, CSTB-3.5/CSTB-4S = 3.5 N·m, CSTB-5 = 5 N·m

INSERT

ZPCW-QBN

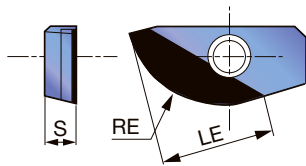

P Steel										
M Stainless										
K Cast iron			★							
N Non-ferrous										
S Superalloys										
H Hard materials										

★ : First choice
☆ : Second choice

Designation	RE	CBN										S	LE	
		BX480												
ZPCW2003-QBN	10	●											3.18	12
ZPCW25H3-QBN	12.5	●											3.5	15.5
ZPCW30T3-QBN	15	●											3.97	18
ZPCW4004-QBN	20	●											4.76	23
ZPCW5004-QBN	25	●											4.76	28

● : Line up
BX480 : 1 piece per package

STANDARD CUTTING CONDITIONS

Please scan below.

e-catalog



EBB

EBD

Ball nose endmill for roughing

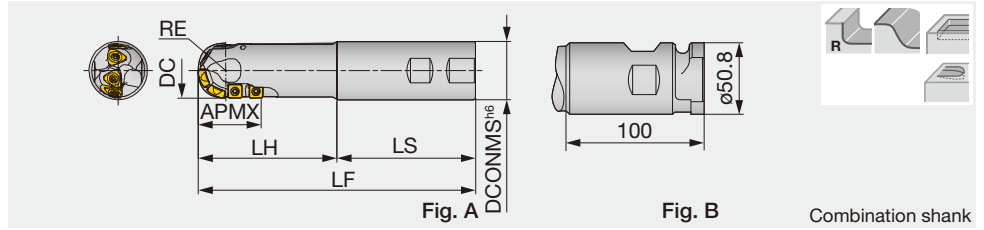

Designation	APMX	DC	CICT	DCONMS	LS	LH	LF	RE	Fig.	Insert R	Insert P
EBD040SSE	45	40	4 (7)	42	100	100	200	20	A	ZDMT4005-MJ	SCMT09T308-23
EBD040MSE	45	40	4 (7)	42	100	150	250	20	A	ZDMT4005-MJ	SCMT09T308-23
EBD050SSE	59	50	4 (7)	42	100	100	200	25	A	ZDMT5006-MJ	SCMT120408-23
EBD050MSE	59	50	4 (7)	42	100	150	250	25	A	ZDMT5006-MJ	SCMT120408-23
EBD050SCE	59	50	4 (7)	50.8	100	100	200	25	B	ZDMT5006-MJ	SCMT120408-23
EBD050MCE	59	50	4 (7)	50.8	100	150	250	25	B	ZDMT5006-MJ	SCMT120408-23

SPARE PARTS

Designation	Clamping screw	Lubricant	Wewnch
EBD040*SE	CSTB-4M	M-1000	T-15T
EBD050**E	CSTB-5	M-1000	T-20T

Recommended clamping torque : CSTB-4M = 3.5 N·m, CSTB-5 = 5 N·m

INSERT

ZDMT-MJ (For R edge)

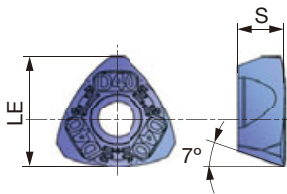

SCMT-23 (For P edge)

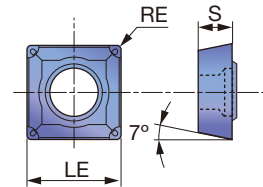

Material	Symbol	Choice
P Steel	☆	Second choice
M Stainless	☆	Second choice
K Cast iron	★	First choice
N Non-ferrous	☆	Second choice
S Superalloys	☆	Second choice
H Hard materials	☆	Second choice

Designation	RE	Coated								LE	S
		AH120									
ZDMT4005-MJ	-	●								13	5.5
ZDMT5006-MJ	-	●								16.2	6.5
SCMT09T308-23	0.8	●								9.525	3.97
SCMT120408-23	0.8	●								12.7	4.76

●: Line up

STANDARD CUTTING CONDITIONS

Please scan below.

e-catalog



EBD

Grade
Insert
Ext. Toolholder
Int. Toolholder
Threading
Grooving
Miniature tool
Milling cutter
Endmill
Drilling tool
Tooling System
User's Guide
Index

A
B
C
D
E
F
G
H
I
J
K
L
M

- High Feed Milling
- Face Milling
- Shoulder Milling
- Slot Milling
- Profile Milling
- Chamfering, Counterbore
- Finish Face Milling
- Approach angle
- 7°-25°
- 41°-45°
- 60°-70°
- 85°-88°
- 90°
- Others

TUNGQUAD

EASD05

Chamfering endmill

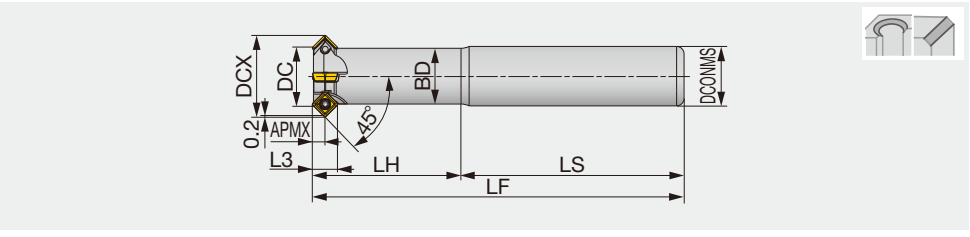

GAMP = +5°, GAMF = -7° ~ +12°

Designation	DCX	CICT	DC*	BD	APMX	DCONMS	LH	L3	LS	LF	Air hole	Insert
EASD05M006C12.0R01	12	1	5.7	7.5	3	12	40	6.8	60	100	Without	SD*T0502...
EASD05M008C12.0R02	14	2	7.8	9.1	3	12	40	6.8	60	100	Without	SD*T0502...
EASD05M016C16.0R04	22	4	15.7	15	3	16	40	6.8	60	100	Without	SD*T0502...

The minimum chamfering diameter (DC) measures up to the point where the insert's nose radius ends. This will offset the total tool length by shortening 0.3 mm.

SPARE PARTS

Designation	Clamping screw	Wrench
EASD05...	CSPB-2L043	IP-6DB

Recommended clamping torque: 0.7 N·m

INSERT

SDMT05-MJ

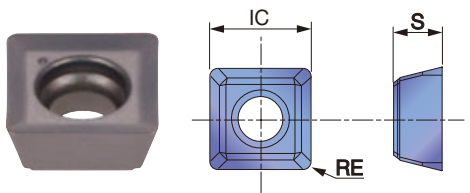

SDHT05-AJ

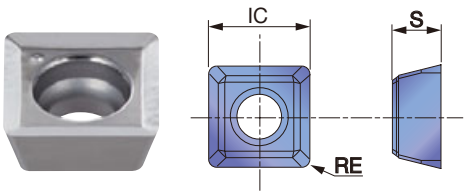

P	Steel		★								
M	Stainless	★	☆								
K	Cast iron		★								
N	Non-ferrous				★						
S	Superalloys		★								
H	Hard materials										

★ : First choice
☆ : Second choice

Designation	RE	APMX	Coated		Uncoated	S	IC
			AH140	AH725			
SDMT050204PN-MJ	0.4	4	●	●		2.38	5.09
SDHT050204FN-AJ	0.4	4			●	2.39	5.09

● : Line up

CUTTING PERFORMANCE

Chamfering & countersinking

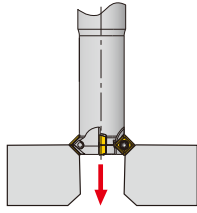

■ C2.5 (45° x 2.5 mm)

Workpiece material: S55C / C55

Designation	Cutting speed Vc (m/min)	Feed rate fz (mm/z)
EASD05M006C12.0R01	80 - 120	0.03 - 0.08
EASD05M008C12.0R02	80 - 120	0.03 - 0.08
EASD05M016C16.0R04 (*z=2)	80 - 120	0.03 - 0.08

Interpolated chamfering

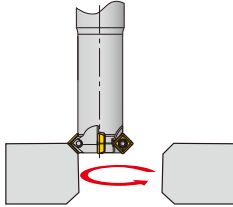

■ C2.5 (45° x 2.5 mm)

Workpiece material: S55C / C55

Designation	Cutting speed Vc (m/min)	Feed rate fz (mm/z)
EASD05M006C12.0R01	80 - 120	0.08 - 0.12
EASD05M008C12.0R02	80 - 120	0.08 - 0.12
EASD05M016C16.0R04	80 - 120	0.08 - 0.12

Back chamfering

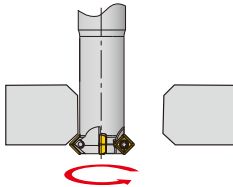

■ C1.0 (45° x 1.0 mm)

Workpiece material: S55C / C55

Designation	Cutting speed Vc (m/min)	Feed rate fz (mm/z)
EASD05M006C12.0R01	80 - 120	0.08 - 0.12
EASD05M008C12.0R02	80 - 120	0.08 - 0.12
EASD05M016C16.0R04	80 - 120	0.08 - 0.12

STANDARD CUTTING CONDITIONS

■ Interpolated or back chamfering type

ISO	Workpiece material	Brinell hardness (HB)	Grade	Cutting speed Vc (m/min)	Feed per tooth fz (mm/t)
P	Low carbon steels S15C, etc. C15E4, etc.	- 200	AH725	230 ~ 320	0.04 ~ 0.1
	High carbon steels S45C, etc. C45, etc.	200 - 300	AH725	150 ~ 230	0.04 ~ 0.1
	Alloyed steels SCM440, etc. 42CrMo4, etc.	150 - 300	AH725	150 ~ 230	0.04 ~ 0.1
	Tool steels SKD11, etc. X153CrMoV12, etc.	- 300	AH725	110 ~ 130	0.03 ~ 0.09
M	Stainless steels SUS304, etc. X5CrNi18-9, etc.	-	AH140	100 ~ 200	0.03 ~ 0.09
K	Grey cast irons FC250, etc. 250, etc.	150 - 250	AH725	150 ~ 250	0.05 ~ 0.12
	Ductile cast irons FCD450, etc. 450-10S, etc.	150 - 250	AH725	100 ~ 180	0.05 ~ 0.12
N	Aluminium alloys Si < 13%	-	TH10	350 ~ 500	0.05 ~ 0.15
	Copper alloys	-	TH10	100 ~ 200	0.05 ~ 0.15

STANDARD CUTTING CONDITIONS

Front chamfering type

ISO	Workpiece material	Brinell hardness (HB)	Grade	Cutting speed Vc (m/min)	Feed per tooth fz (mm/t)
P	Low carbon steels S15C, etc. C15E4, etc.	- 200	AH725	160 ~ 220	0.04 ~ 0.1
	High carbon steels S45C, etc. C45, etc.	200 - 300	AH725	110 ~ 160	0.04 ~ 0.1
	Alloyed steels SCM440, etc. 42CrMo4, etc.	150 - 300	AH725	110 ~ 160	0.04 ~ 0.1
M	Tool steels SKD11, etc. X153CrMoV12, etc.	- 300	AH725	80 ~ 90	0.03 ~ 0.09
K	Stainless steels SUS304, etc. X5CrNi18-9, etc.	-	AH140	70 ~ 140	0.03 ~ 0.09
K	Grey cast irons FC250, etc. 250, etc.	150 - 250	AH725	110 ~ 180	0.05 ~ 0.12
	Ductile cast irons FCD450, etc. 450-10S, etc.	150 - 250	AH725	70 ~ 130	0.05 ~ 0.12
N	Aluminium alloys Si < 13%	-	TH10	250 ~ 350	0.05 ~ 0.15
	Copper alloys	-	TH10	70 ~ 140	0.05 ~ 0.15

* When chamfering over C1.0 (45° x 1.0 mm), decrease the cutting parameters to 70% of the above parameters.

APPLICATION RANGE

Front chamfering

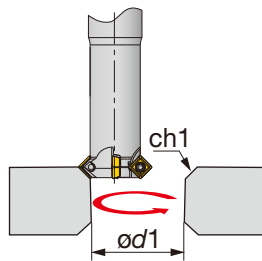

Back chamfering

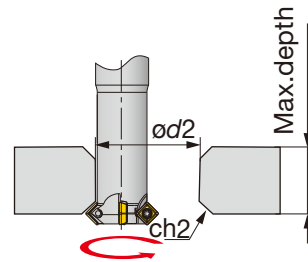

Designation	Minimum hole diameter to be chamfered (mm)		Maximum chamfer dimension (at 45°) (mm)		Maximum reachable hole distance when back chamfering (mm)
	Front-chamfer ød1	Back-chamfer ød2	Front ch1	Back ch2	Max. depth
EASD05M006C12.0R01	5.7	12.5	2.9 x 2.9	2 x 2	18.2
EASD05M008C12.0R02	7.8	14.5	2.9 x 2.9	1.5 x 1.5	33.2
EASD05M016C16.0R04	15.8	22.5	2.9 x 2.9	2.8 x 2.8	43.2

ECP4400R

Chamfering endmill, screw clamp system, for square inserts

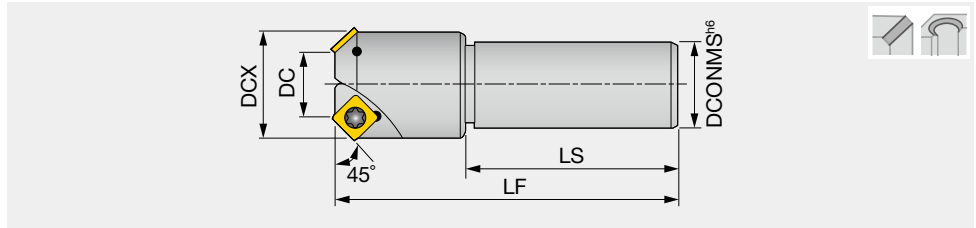

Designation	DC	CICT	DCX	DCONMS	LF	LS	Insert
ECP440AR	10	1	27.5	32	130	80	SPMA422*N
ECP4423R	23	2	40.3	32	130	80	SPMA422*N
ECP4436R	36	3	53.3	32	130	80	SPMA422*N

SPARE PARTS



Designation	Clamping screw	Wrench
ECP44...	CSTA-4	T-15D

Recommended clamping torque: 3.5 N·m

INSERT

SPMA42

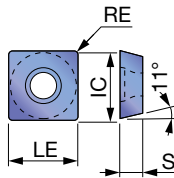

	P	M	K	N	S	H
Steel	★	☆		☆		
Stainless						
Cast iron			★			
Non-ferrous						
Superalloys						
Hard materials						

★ : First choice
☆ : Second choice

Designation	RE	Cermet		Uncoated		LE	IC	S
		NS740	N308	UX30	TH10			
SPMA422TN	0.8	●	●	●		12.7	12.7	3.18
SPMA422FN	0.8			●		12.7	12.7	3.18

● : Line up

STANDARD CUTTING CONDITIONS

Please scan below.

e-catalog



ECP4400R



ECC31

Chamfering endmill, screw clamp system, for large parallelogram inserts

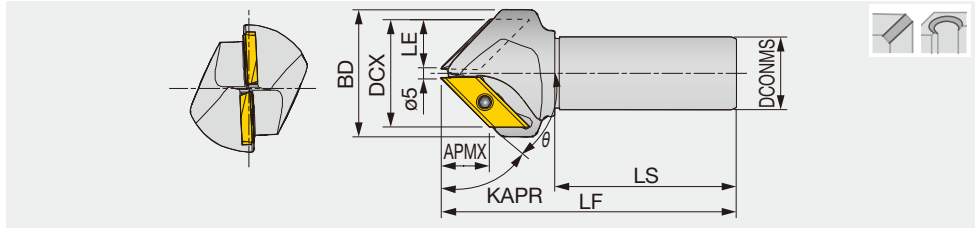

Designation	DCX	CICT	θ	KAPR	BD	LE	APMX	DCONMS	LS	LF	Insert
ECC31005R-30	34	1	30°	60°	40	14.5	25.5	32	80	130.2	XCET3104...
ECC31005R-45	46	2	45°	45°	56	20.5	20.5	32	80	130.1	XCET3104...
ECC31005R-60	55	2	60°	30°	72	25.5	14.5	32	80	130.1	XCET3104...

SPARE PARTS

Designation	Clamping screw	Lubricant	Wrench
ECC31...	CSTB-5S	M-1000	T-20D

* Recommended clamping torque: CSTB-5S=5

INSERT

XCET31

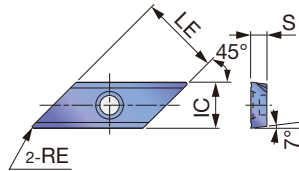

	P	M	K	N	S	H
Steel	★☆☆	★☆☆	★☆☆	★☆☆	★☆☆	★☆☆
Stainless	★☆☆	★☆☆	★☆☆	★☆☆	★☆☆	★☆☆
Cast iron	★☆☆	★☆☆	★☆☆	★☆☆	★☆☆	★☆☆
Non-ferrous	★☆☆	★☆☆	★☆☆	★☆☆	★☆☆	★☆☆
Superalloys	★☆☆	★☆☆	★☆☆	★☆☆	★☆☆	★☆☆
Hard materials	★☆☆	★☆☆	★☆☆	★☆☆	★☆☆	★☆☆

★ : First choice
☆ : Second choice

Designation	RE	Coated		Cermet	Un-coated	LE	IC	S
		AH3135	AH330	AH120	NS740			
XCET310404ER	0.4	●	●	●	●	22	12.7	4.5

●: Line up

STANDARD CUTTING CONDITIONS

ISO	Workpiece material	Hardness (HB)	Grade	No. of revolutions: n (min-1)	Feed per tooth: fz (mm/t)
P	Carbon steels, Alloy steels S55C, C55, etc. SCM440, 42CrMo4, etc.	< 300	NS740	1000 - 3000 - 7000	0.1 - 0.25
			UX30	700 - 2000 - 4900	0.1 - 0.25
	Die steels SKD61, etc. X40CrMoV5-1, etc.	< 300	AH3135	1000 - 3000 - 7000	0.1 - 0.2
M	Stainless steels SUS304, etc. X5CrNi18-10, etc.	< 250	AH3135	1000 - 3000 - 7000	0.1 - 0.25
K	Cast irons FC250, etc. 250, etc.	150 - 250	AH330	1000 - 3000 - 7000	0.1 - 0.25

Notes:

- When the hole diameter to be chamfered is small or the cutting edges near the front end of tool are used, use at higher side of the revolution range shown in the Table.
In contrast, when the hole diameter to be chamfered is large or the cutting edges far from the tool's front end are used, use the lower side of the revolution range shown in the Table.

- When chamfering a small diameter hole (smaller than ø10 mm) in a plungemilling mode, peck-feeding should not be used.
- When the hole diameter to be chamfered is smaller than ø10 mm or the cutting edges near the tool's front end are used, the feed should be set within 0.15 mm/t.

Guidelines for programming

Z-axis plunging depth Z_d (mm) in 45° chamfering of hole

Hole dia. ød (mm)	Size of chamfering C (mm)						
	0.5	1	1.5	2	3	4	5
5	0.7	1.2	1.7	2.2	3.2	-	-
6	1.2	1.7	2.2	2.7	3.7	-	-
6.8	1.6	2.1	2.6	3.1	4.1	-	-
8	2.2	2.7	3.2	3.7	4.7	-	-
8.5	2.4	2.9	3.4	3.9	4.9	-	-
10	3.2	3.7	4.2	4.7	5.7	6.7	7.7
10.2	3.3	3.8	4.3	4.8	5.8	6.8	7.8
12	4.2	4.7	5.2	5.7	6.7	7.7	8.7
14	5.2	5.7	6.2	6.7	7.7	8.7	9.7
16	6.2	6.7	7.2	7.7	8.7	9.7	10.7
17.5	6.9	7.4	7.9	8.4	9.4	10.4	11.4
20	8.2	8.7	9.2	9.7	10.7	11.7	12.7
21	8.7	9.2	9.7	10.2	11.2	12.2	13.2
24	10.2	10.7	11.2	11.7	12.7	13.7	14.7
30	13.2	13.7	14.2	14.7	15.7	16.7	17.7
33	14.7	15.2	15.7	16.2	17.2	18.2	19.2
36	16.2	16.7	17.2	17.7	18.7	19.7	-
42	19.2	19.7	20.2	-	-	-	-

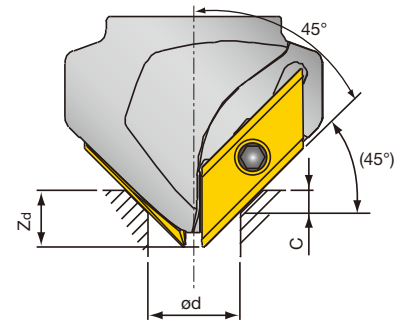

Tool: ECC31005R-45

Note: When the hole depth is smaller than the Z-axis plunging depth (Z_d), special care should be taken to avoid an interference between the tool's front end and the bottom of the hole.

Z-axis plunging depth Z_d (mm) in 30° chamfering of hole

Hole dia. ød (mm)	Size of chamfering C (mm)						
	0.5	1	1.5	2	2.5	3	3.5
5	0.6	1.1	1.6	2.1	-	-	-
6	0.9	1.4	1.9	2.4	-	-	-
6.8	1.1	1.6	2.1	2.6	-	-	-
8	1.4	1.9	2.4	2.9	-	-	-
8.5	1.6	2.1	2.6	3.1	-	-	-
10	2	2.5	3	3.5	4	4.5	5
10.2	2.1	2.6	3.1	3.6	4.1	4.6	5.1
12	2.6	3.1	3.6	4.1	4.6	5.1	5.6
16	3.7	4.2	4.7	5.2	5.7	6.2	6.7
17.5	4.2	4.7	5.2	5.7	6.2	6.7	7.2
20	4.9	5.4	5.9	6.4	6.9	7.4	7.9
21	5.2	5.7	6.2	6.7	7.2	7.7	8.2
24	6.1	6.6	7.1	7.6	8.1	8.6	9.1
30	7.8	8.3	8.8	9.3	9.8	10.3	10.8
33	8.7	9.2	9.7	10.2	10.7	11.2	11.7
36	9.5	10	10.5	11	11.5	12	12.5
38	10.1	10.6	11.1	11.6	12.1	12.6	13.1
42	11.2	11.7	12.2	12.7	13.2	13.7	14.2
46	12.4	12.9	13.4	13.9	14.4	-	-
48	13	13.5	14	14.5	-	-	-
52	14.1	-	-	-	-	-	-

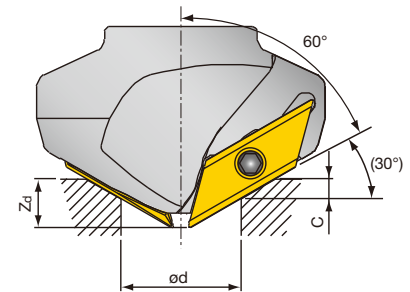

Tool: ECC31005R-60

Note: When the hole depth is smaller than the Z-axis plunging depth (Z_d), special care should be taken to avoid an interference between the tool's front end and the bottom of the hole.

Z-axis plunging depth Z_d (mm) in 60° chamfering of hole

Hole dia. ød (mm)	Size of chamfering C (mm)							
	0.5	1	1.5	2	2.5	3	3.5	4
5	0.8	1.3	1.8	2.3	2.8	-	-	-
6	1.7	2.2	2.7	3.2	3.7	-	-	-
6.8	2.4	2.9	3.4	3.9	4.4	-	-	-
8	3.4	3.9	4.4	4.9	5.4	-	-	-
8.5	3.8	4.3	4.8	5.3	5.8	-	-	-
10	5.1	5.6	6.1	6.6	7.1	7.6	8.1	8.6
10.2	5.3	5.8	6.3	6.8	7.3	7.8	8.3	8.8
12	6.9	7.4	7.9	8.4	8.9	9.4	9.9	10.4
16	10.3	10.8	11.3	11.8	12.3	12.8	13.3	13.8
17.5	11.6	12.1	12.6	13.1	13.6	14.1	14.6	15.1
20	13.7	14.2	14.7	15.2	15.7	16.2	16.7	17.2
21	14.6	15.1	15.6	16.1	16.6	17.1	17.6	18.1
24	17.2	17.7	18.2	18.7	19.2	19.7	20.2	20.7
30	22.4	22.9	23.4	23.9	24.4	24.9	25.4	-
33	24.9	25.4	-	-	-	-	-	-

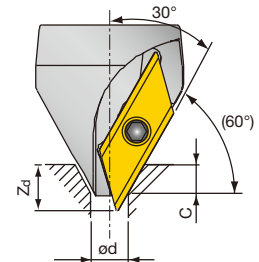

Tool: ECC31005R-30

Note: When the hole depth is smaller than the Z-axis plunging depth (Z_d), special care should be taken to avoid an interference between the tool's front end and the bottom of the hole.



TCB

Counterboring endmill, monoblock type

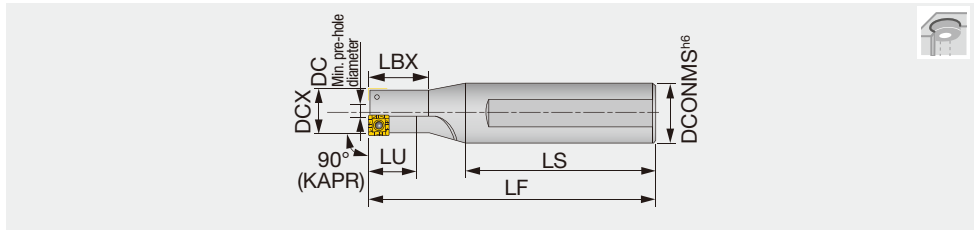

Designation	DCX	CICT	DC	LU	LBX	LF	LS	DCONMS	Insert
TCB100F16	10	1	2.8	13	17	86	60	16	SPMP771...
TCB110F16	11	1	2.8	14	18.7	87	60	16	SPMP771...
TCB120F20	12	1	3.6	15	20.5	89	60	20	SPMP771...
TCB130F20	13	2	4.5	16	22.2	91	60	20	SPMP771...
TCB-140	14	1	4	11	18	117	80	25	SPMP831...
TCB140F25	14	2	5.5	18	24	113	80	25	SPMP771...
TCB150F25	15	2	6.5	19	25.7	114	80	25	SPMP771...
TCB160F25	16	2	7.5	20	27.5	116	80	25	SPMP771...
TCB170F25	17	2	6.6	13	21	114	80	25	SPMP831...
TCB175F25	17.5	2	7.1	14	22	115	80	25	SPMP831...
TCB180F25	18	2	7.5	15	23	116	80	25	SPMP831...
TCB190F25	19	2	8.5	15	24	118	80	25	SPMP831...
TCB-200	20	2	8.2	16	25	120	80	25	SPMP042...
TCB200F25	20	2	8.2	16	25	120	80	25	SPMP042...
TCB210F25	21	2	9	17	26	122	80	25	SPMP042...
TCB220F25	22	2	10	18	28	124	80	25	SPMP042...
TCB-230	23	2	11	19	29	126	80	25	SPMP042...
TCB230F25	23	2	11	19	29	126	80	25	SPMP042...
TCB240F25	24	2	12	20	-	128	80	25	SPMP042...
TCB250F25	25	2	13	25	-	130	80	25	SPMP042...
TCB-260	26	2	14	21	33	132	80	32	SPMP042...
TCB-290	29	2	14	23	36	138	80	32	SPMM322...
TCB-320	32	2	16.9	40	-	144	80	32	SPMM322...
TCB-350	35	2	14	43	-	150	80	32	SPMM432...
TCB-390	39	2	17.9	48	-	158	80	32	SPMM432...
TCB-430	43	2	21.7	53	-	171	85	42	SPMM432...

Tool diameter tolerance	Applicable tolerance range of hole diameter
+0.2 / 0	+0.3 / 0

Countersink dimensions of bolt hole

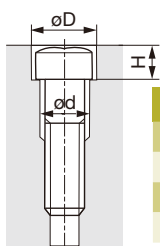

Thread size	M6	M8	M10	M12	M14	M16	M18	M20	M22	M24	M27
øD (mm)	11	14	17.5	20	23	26	29	32	35	39	43
H (mm)	6.5	8.6	10.8	13	15.2	17.5	19.5	21.5	23.5	25.5	29
ød (mm)	6	9	11	14	16	18	20	22	24	26	30
Applicable tool	TCB110	TCB140	TCB175	TCB200	TCB230	TCB260	TCB290	TCB320	TCB350	TCB390	TCB430

SPARE PARTS



Designation	Clamping screw	Wrench
TCB100... - TCB160...	CSTB-2L040	T-6D
TCB-140...	CSTB-2.2S	T-7D
TCB170... - TCB190...	CSTB-2.2	T-7D
TCB200... - TCB260...	CSTA-NO3	T-9D
TCB-290 - TCB-320	CSTA-NO5	T-9D
TCB-350 - TCB-430	CSTA-4	T-15D

Recommended clamping torque: CSTB-2L040 = 0.7 N·m, CSTB-2.2S / CSTB-2.2 = 1 N·m, CSTA-NO3 / CSTA-NO5 = 2.3 N·m, CSTA-4 = 3.5 N·m

Reference pages: Inserts → [H219](#), Standard cutting conditions → [H219 - H220](#)

TCB

Counterboring endmill, cartridge type

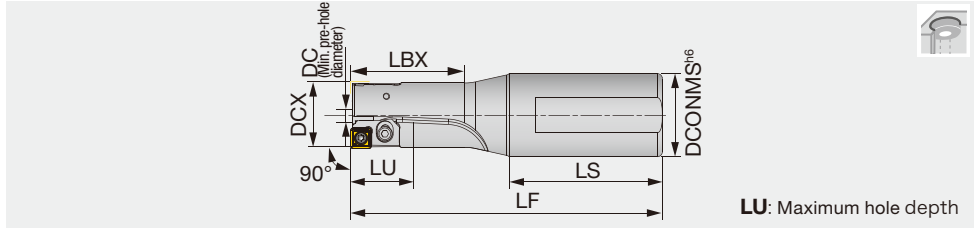

Body Designation	DCX	DCONMS	DC	LU	LS	LBX	LF	WT(kg)	Cartridge set Designation	Shim plate Designation	Shim plate Thickness	Insert
TCB260-290F32	26	32	13.2	40	59	43	120	0.6	TCB04CA-26-29	-	-	SPMP042...
TCB260-290F32	27	32	14.2	40	59	43	120	0.6	TCB04CA-26-29	AP16050	0.5	SPMP042...
TCB260-290F32	28	32	15.2	40	59	43	120	0.6	TCB04CA-26-29	AP16100	1	SPMP042...
TCB260-290F32	29	32	16.2	40	59	43	120	0.6	TCB04CA-26-29	AP16150	1.5	SPMP042...
TCB300-340F32	30	32	14.2	45	59	55	130	0.6	TCB32CA-30-39	-	-	SPMM322...
TCB300-340F32	31	32	15.2	45	59	55	130	0.6	TCB32CA-30-39	AP16050	0.5	SPMM322...
TCB300-340F32	32	32	16.2	45	59	55	130	0.6	TCB32CA-30-39	AP16100	1	SPMM322...
TCB300-340F32	33	32	17.2	45	59	55	130	0.6	TCB32CA-30-39	AP16150	1.5	SPMM322...
TCB300-340F32	34	32	18.2	45	59	55	130	0.6	TCB32CA-30-39	AP16200	2	SPMM322...
TCB350-390F32	35	32	19	50	59	70	140	0.7	TCB32CA-30-39	-	-	SPMM322...
TCB350-390F32	36	32	20	50	59	70	140	0.7	TCB32CA-30-39	AP16050	0.5	SPMM322...
TCB350-390F32	37	32	21	50	59	70	140	0.7	TCB32CA-30-39	AP16100	1	SPMM322...
TCB350-390F32	38	32	22	50	59	70	140	0.7	TCB32CA-30-39	AP16150	1.5	SPMM322...
TCB350-390F32	39	32	23	50	59	70	140	0.7	TCB32CA-30-39	AP16200	2	SPMM322...
TCB400-440F32	40	32	18	55	59	80	150	1	TCB43CA-40-59	-	-	SPMM432...
TCB400-440F32	41	32	19	55	59	80	150	1	TCB43CA-40-59	AP21050	0.5	SPMM432...
TCB400-440F32	42	32	20	55	59	80	150	1	TCB43CA-40-59	AP21100	1	SPMM432...
TCB400-440F32	43	32	21	55	59	80	150	1	TCB43CA-40-59	AP21150	1.5	SPMM432...
TCB400-440F32	44	32	22	55	59	80	150	1	TCB43CA-40-59	AP21200	2	SPMM432...
TCB450-490F32	45	32	23	65	59	90	160	1.2	TCB43CA-40-59	-	-	SPMM432...
TCB450-490F32	46	32	24	65	59	90	160	1.2	TCB43CA-40-59	AP21050	0.5	SPMM432...
TCB450-490F32	47	32	25	65	59	90	160	1.2	TCB43CA-40-59	AP21100	1	SPMM432...
TCB450-490F32	48	32	26	65	59	90	160	1.2	TCB43CA-40-59	AP21150	1.5	SPMM432...
TCB450-490F32	49	32	27	65	59	90	160	1.2	TCB43CA-40-59	AP21200	2	SPMM432...
TCB500-540F32	50	32	28	70	59	97	165	1.5	TCB43CA-40-59	-	-	SPMM432...
TCB500-540F32	51	32	29	70	59	97	165	1.5	TCB43CA-40-59	AP21050	0.5	SPMM432...
TCB500-540F32	52	32	30	70	59	97	165	1.5	TCB43CA-40-59	AP21100	1	SPMM432...
TCB500-540F32	53	32	31	70	59	97	165	1.5	TCB43CA-40-59	AP21150	1.5	SPMM432...
TCB500-540F32	54	32	32	70	59	97	165	1.5	TCB43CA-40-59	AP21200	2	SPMM432...
TCB550-590F32	55	32	33	75	59	105	175	1.9	TCB43CA-40-59	-	-	SPMM432...
TCB550-590F32	56	32	34	75	59	105	175	1.9	TCB43CA-40-59	AP21050	0.5	SPMM432...
TCB550-590F32	57	32	35	75	59	105	175	1.9	TCB43CA-40-59	AP21100	1	SPMM432...
TCB550-590F32	58	32	36	75	59	105	175	1.9	TCB43CA-40-59	AP21150	1.5	SPMM432...
TCB550-590F32	59	32	37	75	59	105	175	1.9	TCB43CA-40-59	AP21200	2	SPMM432...

The cartridge sets and shim plates are included.

Tool diameter tolerance	Applicable tolerance range of hole diameter
+0.2 / 0	+0.3 / 0

Countersink dimensions of bolt hole

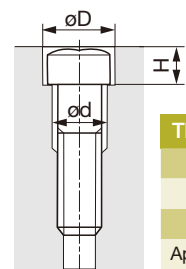

Thread size	M16	M18	M20	M22	M24	M27	M30	M33	M36
øD (mm)	26	29	32	35	39	43	48	54	58
H (mm)	17.5	19.5	21.5	23.5	25.5	29	32	35	38
ød (mm)	18	20	22	24	26	30	33	36	39
Applicable tool	TCB260	TCB290	TCB320	TCB350	TCB390	TCB430	TCB480	TCB540	TCB580

Reference pages: Inserts → [H219](#), Standard cutting conditions → [H219 - H220](#)





Body SPARE PARTS

Designation	① Cartridge screw	② Shim plate	② Shim plate	② Shim plate	② Shim plate	Wrench for cartridge	③ Washer
TCB260-290F32	CM3×0.5×6	AP16050	AP16100	AP16150		P-2.5	3.2X6X0.5
TCB300-340F32	CM3×0.5×6	AP16050	AP16100	AP16150	AP16200	P-2.5	3.2X6X0.5
TCB350-390F32	CM3×0.5×6	AP16050	AP16100	AP16150	AP16200	P-2.5	3.2X6X0.5
TCB400-440F32	CM4×0.7×10	AP21050	AP21100	AP21150	AP21200	P-3	4.3X8X0.5
TCB450-490F32	CM4×0.7×10	AP21050	AP21100	AP21150	AP21200	P-3	4.3X8X0.5
TCB500-540F32	CM4×0.7×10	AP21050	AP21100	AP21150	AP21200	P-3	4.3X8X0.5
TCB550-590F32	CM4×0.7×10	AP21050	AP21100	AP21150	AP21200	P-3	4.3X8X0.5

Cartridge set SPARE PARTS

Designation	④ Insert screw	Wrench
TCB04CA-26-29	CSTA-NO3	T-9D
TCB32CA-30-39	CSTA-NO5	T-9D
TCB32CA-30-39	CSTA-NO5	T-9D
TCB43CA-40-59	CSTA-4	T-15D
TCB43CA-40-59	CSTA-4	T-15D
TCB43CA-40-59	CSTA-4	T-15D
TCB43CA-40-59	CSTA-4	T-15D

Recommended clamping torque: CSTA-NO3 / CSTA-NO5 = 2.3 N·m, CSTA-4 = 3.5 N·m

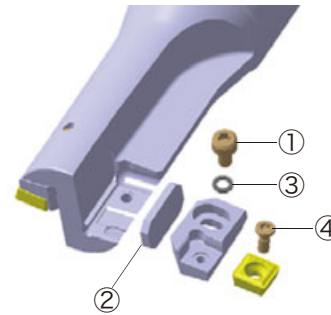

Fine adjustment shim plates (sold separately)

SPARE PARTS

Designation	Thickness
AP16005	0.05
AP16020	0.2
AP21005	0.05
AP21020	0.2

Cautions in preparing the cartridge type cutter

- Firmly press the cartridge in the arrowed direction while tightening the screw to install the cartridge on the cutter body. (Fig.1)
- Ensure that the shim plates thickness are always the same on both sides to equalize the tool diameter. (Fig.2)
- Ensure to locate the shim plate fit within the cartridge pocket. (Fig.2)
- Use thin shim plates (not included) for fine diameter adjustments in $\varnothing 0.1$ mm increments. (Fig.3)
- When using multiple shim plates in one pocket for a diameter adjustment, always use the thinnest shim plates at the bottom to prevent them from dislocating during machining. (Fig.3)
- Ensure that the top shim is always in contact with the rim of the cartridge pocket to prevent it from dislocation during machining. (Fig.4)



Fig.1



Fig.2

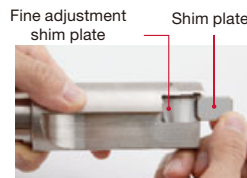

Fig.3



Fig.4

CUSTOM-BUILT TOOL SERVICE

Tungaloy also designs and fabricates semi-standard or tailor-made tools with the TCB inserts according to the desired tool specifications. Contact your Tungaloy representative for further details.

INSERT

SPMP/SPMM

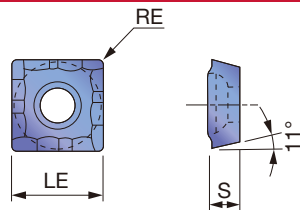

SPMP/SPMM-CG

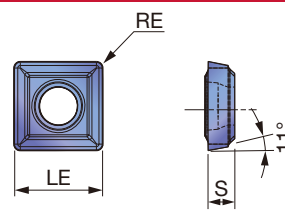

P	Steel	☆	★	★
M	Stainless	☆	★	★
K	Cast iron	☆	★	★
N	Non-ferrous	☆	☆	☆
S	Superalloys	☆	☆	☆
H	Hard materials	☆	☆	☆

★ : First choice
☆ : Second choice

Designation	RE	Coated			LE	S
		T313W	AH6030	AH6225		
SPMP771-CG	0.4	▲	●		5.4	1.61
SPMP831-CG	0.4	▲	●		6.35	2.38
SPMP831DS	0.4	●			6.35	2.38
SPMP832-CG	0.8		●		6.35	2.38
SPMP041ER-CG	0.4		●		7.94	3.18
SPMP042ER-CG	0.8	▲	●		7.94	3.18
SPMP042ERD	0.8	●			7.94	3.18
SPMM321ER-CG	0.4		●		9.53	3.18
SPMM322ER-CG	0.8	▲	●		9.53	3.18
SPMM322ERD	0.8	●			9.53	3.18
SPMM431ER-CG	0.4		●		12.7	4.76
SPMM432ER-CG	0.8	▲	●		12.7	4.76
SPMM432ERD	0.8	●			12.7	4.76

● : Line up
▲ : To be discontinued

STANDARD CUTTING CONDITIONS

Counterboring

ISO	Workpiece material	Hardness	Cutting speed Vc (m/min)	Feed : f (mm/rev)	
				ø10 - 12 (z = 1)	ø13 - 59 (z = 2)
P	Carbon steel	- 300 HB	80 - 200	0.03 - 0.08	0.1 - 0.3
M	Stainless steel	- 200 HB	80 - 150	0.03 - 0.05	0.06 - 0.15
K	Grey cast iron	150 - 250 HB	80 - 200	0.05 - 0.1	0.1 - 0.4
N	Non-ferrous	-	100 - 300	0.05 - 0.2	0.1 - 0.4
S	Superalloys	- 40 HRC	50 - 80	0.03 - 0.05	0.06 - 0.15
H	Hard materials	- 50 HRC	50 - 80	0.03 - 0.05	0.06 - 0.15

Milling

ISO	Workpiece material	Hardness	Cutting speed Vc (m/min)	Feed per tooth fz (mm/t)
P	Carbon steel	- 300 HB	80 - 200	0.05 - 0.15
M	Stainless steel	- 200 HB	80 - 150	0.05 - 0.1
K	Grey cast iron	150 - 250 HB	80 - 200	0.05 - 0.2
N	Non-ferrous	-	100 - 300	0.1 - 0.2
S	Superalloys	- 40 HRC	50 - 80	0.05 - 0.08
H	Hard materials	- 50 HRC	50 - 80	0.05 - 0.08





Internal boring (With one cutting edge)

ISO	Workpiece material	Hardness	Cutting speed Vc (m/min)	Depth of cut ap (mm)	Feed : f (mm/rev)
P	Carbon steel	- 300 HB	80 - 200	0.5 -	0.05 - 0.15
M	Stainless steel	- 200 HB	80 - 150	0.5 -	0.05 - 0.1
K	Grey cast iron	150 - 250 HB	80 - 200	0.5 -	0.05 - 0.2
N	Non-ferrous	-	100 - 300	0.5 -	0.1 - 0.2
S	Superalloys	- 40 HRC	50 - 80	0.5 -	0.05 - 0.08
H	Hard materials	- 50 HRC	50 - 80	0.5 -	0.05 - 0.08

APPLICATION

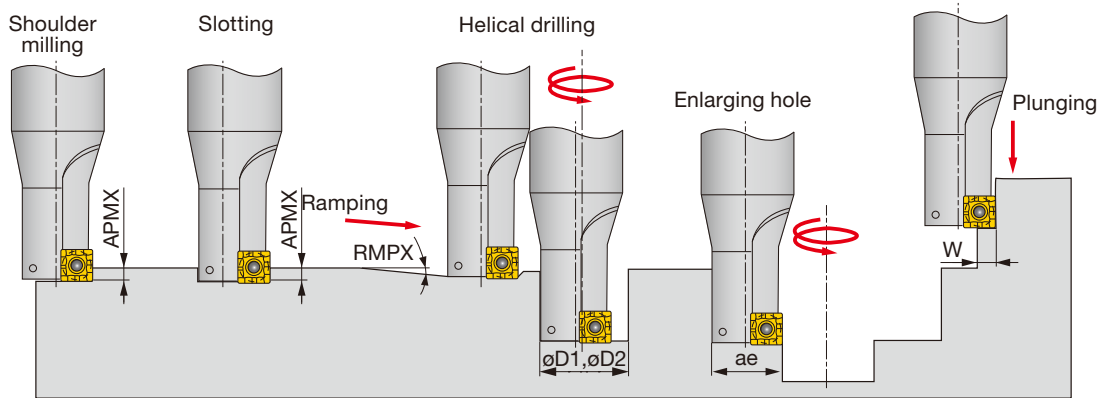

Designation	Tool dia. DCX	Max. depth of cut APMX	Max. ramping angle RMPX	Max. cutting width in plunging W	Min. machinable hole dia. øD1	Max. machinable hole dia. øD2	Max. cutting width in enlarging hole ae
TCB100F16	10	4	-	4	-	-	-
TCB110F16	11	4	2.1°	4	12	20	10
TCB120F20	12	4	2.1°	4	14	22	11
TCB130F20	13	4	2.1°	4	17	24	12
TCB-140	14	5	3°	5	20	25	13
TCB140F25	14	4	1.9°	4	19	26	13
TCB150F25	15	4	1.6°	4	21	28	14
TCB160F25	16	4	1.3°	4	23	30	15
TCB170F25	17	5	2.5°	5	25	32	16
TCB175F25	17.5	5	2.2°	5	25.5	33	16.5
TCB180F25	18	5	2°	5	26	34	17
TCB190F25	19	5	1.5°	5	27	36	18
TCB200F25	20	6	3°	6	29	38	19
TCB210F25	21	6	2.5°	6	30	40	20
TCB220F25	22	6	2°	6	31	42	21
TCB230F25	23	6	1.6°	6	32	44	22
TCB240F25	24	6	1.3°	6	33	46	23
TCB250F25	25	6	1.1°	6	34	48	24.5
TCB-260	26	6	1°	6	35	50	25
TCB-290	29	8	3°	8	37	56	28
TCB-320	32	8	2.5°	8	40	62	31
TCB-350	35	10	2.5°	10	45	68	34
TCB-390	39	10	2°	10	49	76	38
TCB-430	43	10	1.5°	10	53	84	42

The insert can be used for a maximum 2 indexings. (full 4 indexing for a plunging application.)

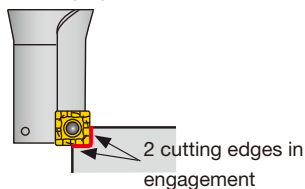

Cautions in shouldering operation

The cutter is design so that the insert provides 1° taper relief on the periphery. The wall, therefore, will be 89° when milled.

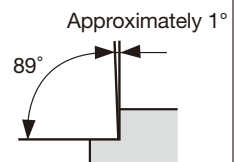

Multi-function endmill, shank type, with center cutting edge

GAMP: Center insert $-2.6^{\circ} \sim -4.4^{\circ}$, Peripheral insert $+6.1^{\circ} \sim +7.1^{\circ}$
GAMF: Center insert $+0.2^{\circ} \sim +1.3^{\circ}$, Peripheral insert $-15.7^{\circ} \sim -15^{\circ}$

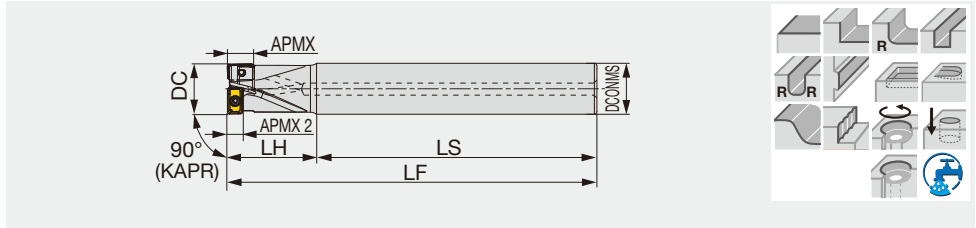

Designation	APMX	APMX 2	DC	CICT	DCONMS	LS	LH	LF	WT(kg)	Air hole	Insert
EVLX08M016C16.0R02	7	4	16	2	16	100	30	130	0.18	With	LXMU08...
EVLX08M016C16.0R02L	7	4	16	2	16	130	50	180	0.25	With	LXMU08...
EVLX08M017C16.0R02L	7	4	17	2	16	155	25	180	0.26	With	LXMU08...
EVLX10M020C20.0R02	9	4	20	2	20	110	35	145	0.31	With	LXMU10...
EVLX10M020C20.0R02L	9	4	20	2	20	130	60	190	0.41	With	LXMU10...
EVLX10M021C20.0R02L	9	4	21	2	20	160	30	190	0.42	With	LXMU10...
EVLX12M025C25.0R02	11	6	25	2	25	105	45	150	0.51	With	LXMU12...
EVLX12M025C25.0R02L	11	6	25	2	25	150	75	225	0.77	With	LXMU12...
EVLX12M026C25.0R02L	11	6	26	2	25	190	35	225	0.8	With	LXMU12...

HVLX08/10/12-M

Multi-function endmill, modular type (TungFlex), with center cutting edge

GAMP: Center insert $-2.6^{\circ} \sim -4.4^{\circ}$, Peripheral insert $+6.1^{\circ} \sim +7.1^{\circ}$
GAMF: Center insert $+0.2^{\circ} \sim +1.3^{\circ}$, Peripheral insert $-15.7^{\circ} \sim -15^{\circ}$

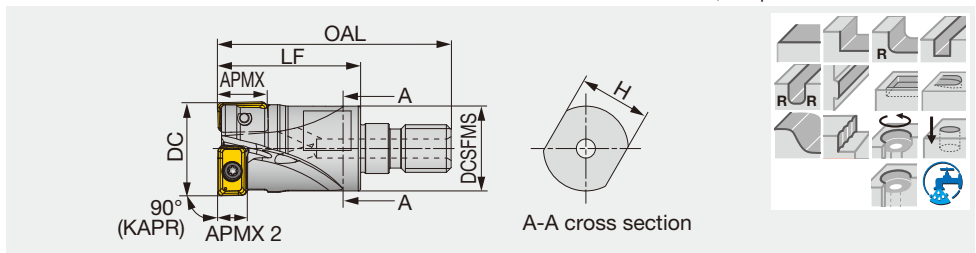

Designation	APMX	APMX 2	DC	CICT	OAL	LF	H	DCSFMS	CRKS	WT(kg)	Air hole	Insert
HVLX08M016M08R02	7	4	16	2	42	25	10	14.5	M8	0.03	With	LXMU08...
HVLX08M017M08R02	7	4	17	2	42	25	10	14.5	M8	0.04	With	LXMU08...
HVLX10M020M10R02	9	4	20	2	49	30	15	17.8	M10	0.05	With	LXMU10...
HVLX10M021M10R02	9	4	21	2	49	30	15	17.8	M10	0.06	With	LXMU10...
HVLX12M025M12R02	11	6	25	2	57	35	17	23	M12	0.1	With	LXMU12...
HVLX12M026M12R02	11	6	26	2	57	35	17	23	M12	0.1	With	LXMU12...

SPARE PARTS



Designation	Clamping screw	Wrench
E/HVLX08...	CSPB-2.2	IP-7D
E/HVLX10...	SR-M2.5x0.45-L6IP7	IP-7D
E/HVLX12...	TS30100I/HG-P	IP-9D

Recommended clamping torque: CSPB-2.2, SR-M2.5x0.45-L6IP7 = 1 N·m, TS30100I/HG-P = 2 N·m



INSERT

LXMU-MM

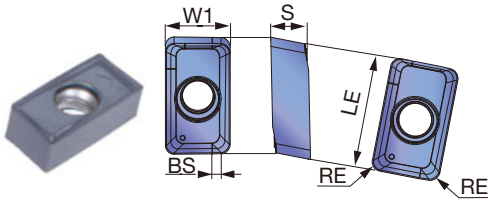

P	Steel	★	☆						
M	Stainless	★							
K	Cast iron		☆	★					
N	Non-ferrous								
S	Superalloys	☆		★					
H	Hard materials			★					

★ : First choice
☆ : Second choice

Designation	RE	APMX	Coated			LE	W1	S	BS
			AH3225	AH120	AH8015				
LXMU080304PER-MM	0.4	7	●	●	●	7.7	5	2.8	0.8
LXMU10T304PER-MM	0.4	9	●	●		10	6	3.2	1.2
LXMU10T308PER-MM	0.8	9	●	●	●	10	6	3.2	0.8
LXMU120404PER-MM	0.4	11	●	●		12.2	7.1	4.2	1.2
LXMU120408PER-MM	0.8	11	●	●	●	12.2	7.1	4.2	0.8

● : Line up

STANDARD CUTTING CONDITIONS

ISO	Workpiece materials	Hardness	Grades	Cutting speed Vc (m/min)	Drilling (ZEFP = 1)* Feed per revolution f (mm/rev)	Shouldering / Helical interpolation*	
						Feed per tooth fz (mm/t)	
						08	10 / 12
P	Low carbon steel S15C, SS400, etc. C15E4, E275A, etc.	- 200 HB	AH3225	100 - 300	0.03 - 0.08	0.05 - 0.25	0.05 - 0.3
	Carbon steel and alloy steel S55C, SCM440, etc. C55, 42CrMo4, etc.	- 300 HB	AH3225	100 - 250	0.03 - 0.08	0.05 - 0.25	0.05 - 0.3
	Prehardened steel NAK80, PX5, etc.	30 - 40 HRC	AH3225	100 - 200	0.03 - 0.06	0.05 - 0.2	0.05 - 0.25
M	Stainless steel SUS304, SUS316, etc. X5CrNi18-9, X5CrNiMo17-12-3, etc.	-	AH3225	80 - 180	0.03 - 0.08	0.05 - 0.2	0.05 - 0.22
K	Grey cast iron FC250, FC300, etc. 250, 300, etc.	150 - 250 HB	AH120, AH8015	100 - 300	0.03 - 0.1	0.05 - 0.25	0.05 - 0.3
	Ductile cast iron FCD400, FCD600, etc. 400-15S, 600-3, etc.	150 - 250 HB	AH120, AH8015	100 - 250	0.03 - 0.08	0.05 - 0.2	0.05 - 0.25
S	Titanium alloys Ti-6Al-4V, etc.	-	AH3225	20 - 60	0.03 - 0.06	0.04 - 0.15	0.04 - 0.15
	Superalloys Inconel 718, etc.	-	AH8015	20 - 40	0.03 - 0.06	0.04 - 0.15	0.04 - 0.15
H	Hardened steel	SKD61, etc. X40CrMoV5-1, etc.	40 - 50 HRC	AH8015	50 - 150	0.03 - 0.05	0.04 - 0.15
		SKD11, etc. X153CrMoV12, etc.	50 - 60 HRC	AH8015	40 - 70	0.03 - 0.05	0.04 - 0.15

*In the following cases, feed as if the cutter has a single effective cutting edge (ZEFP = 1):
 - Hole making
 - Helical interpolating for holes with a hole diameter (øD) ≤ 1.25x the tool diameter (DC)
 - The axial D.O.C. exceeds APMX2 (See next page for APMX2)

APPLICATION RANGE

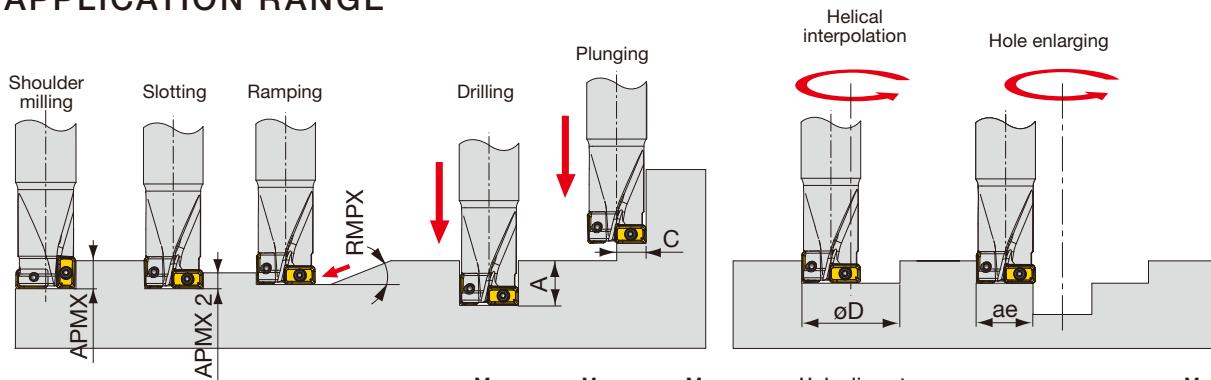

Designation	DC	Max. depth of cut		Max. drilling depth*	Max. cutting width in plunging	Max. ramping angle	Hole diameters (w/ flat bottom) machinable		Hole diameters machinable		Max. cutting width engagement
		APMX	APMX 2				A	C	RMPX	ϕD_{min}	
E/HVLX08M016...	16	7	4	12	8	90°	17	30.75	16	31.75	14
E/HVLX08M017...	17	7	4	12	8.5	90°	19	32.75	17	33.75	15
E/HVLX10M020...	20	9	4	15	10	90°	22	37.95	20	39.15	18
E/HVLX10M021...	21	9	4	15	10.5	90°	23.35	39.95	21	40.95	19
E/HVLX12M025...	25	11	6	18.5	12.5	90°	26.65	47.85	25	48.95	23
E/HVLX12M026...	26	11	6	18.5	13	90°	28.65	49.85	26	50.95	24

*Use pecking or dwelling method when drilling holes deeper than 5 mm.

HOLE BOTTOM PROFILE AFTER DRILLING

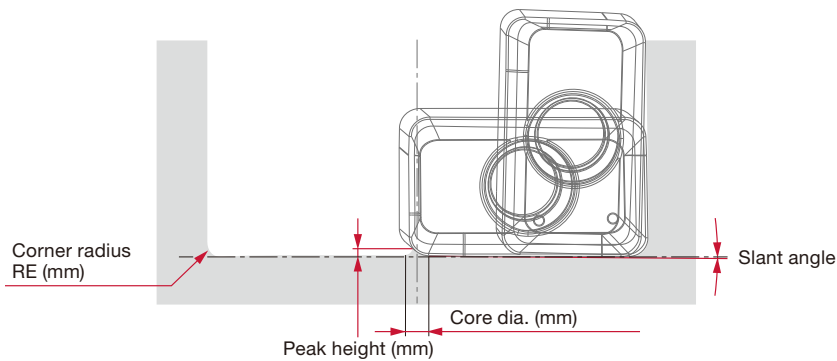

DC	D16		D17		D20		D21		D25		D26	
Insert	LXMU08...		LXMU10...		LXMU10...		LXMU10...		LXMU12...		LXMU12...	
RE (mm)	0.4		0.4		0.8		0.4		0.8		0.4	
Peak height (mm)	0.43		0.86		0.1		0.24		0.86		0.86	
Core dia. (mm)	0.9		1.9		0.21		1.02		1.22		2.02	
Slant angle	Conical shape with $\approx 0.3^\circ$ slant angle											

Grade

Insert

Ext. Toolholder

Int. Toolholder

Threading

Grooving

Miniature tool

Milling cutter

Endmill

Drilling tool

Tooling System

User's Guide

Index



EVX

Multi purpose endmill, shank type, with center cutting edge

Standard type GAMP = +2°~ +5°, GAMF = -10°~ -3.5°
Long type GAMP = +5°, GAMF = -4°~ -2°

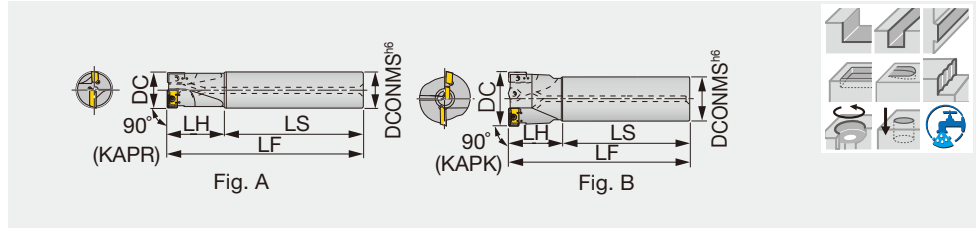

Designation	APMX	DC	CICT	DCONMS	LS	LH	LF	Coolant hole	Fig.	Insert
EVX08016RSA	7	16	2	16	90	30	120	With	A	XXMU08...
EVX08016RS	7	16	2	16	90	30	120	Without	A	XXMU08...
EVX08016RLA	7	16	2	16	135	40	175	With	A	XXMU08...
EVX08016RL	7	16	2	16	135	40	175	Without	A	XXMU08...
EVX10020RSA	9	20	2	20	90	30	120	With	A	XXMU10...
EVX10020RS	9	20	2	20	90	30	120	Without	A	XXMU10...
EVX10020RLA	9	20	2	20	135	50	185	With	A	XXMU10...
EVX10020RL	9	20	2	20	135	50	185	Without	A	XXMU10...
EVX12025RSA	11.5	25	2	25	100	40	140	With	A	XXMU12...
EVX12025RS	11.5	25	2	25	100	40	140	Without	A	XXMU12...
EVX12025RLA	11.5	25	2	25	150	70	220	With	A	XXMU12...
EVX12025RL	11.5	25	2	25	150	70	220	Without	A	XXMU12...
EVX16032RSA	15	32	2	32	110	50	160	With	A	XXMU16...
EVX16032RS	15	32	2	32	110	50	160	Without	A	XXMU16...
EVX16032RLA	15	32	2	32	175	80	255	With	A	XXMU16...
EVX16032RL	15	32	2	32	175	80	255	Without	A	XXMU16...
EVX12040RSA	11.5	40	2	42	120	60	180	With	B	XXMU12, WCMT05...
EVX12040RS	11.5	40	2	42	120	60	180	Without	B	XXMU12, WCMT05...
EVX12040RLA	11.5	40	2	42	210	100	310	With	B	XXMU12, WCMT05...
EVX12040RL	11.5	40	2	42	210	100	310	Without	B	XXMU12, WCMT05...
EVX16050RSA	15	50	2	42	160	50	210	With	B	XXMU16, WCMT06...
EVX16050RS	15	50	2	42	160	50	210	Without	B	XXMU16, WCMT06...
EVX16050RLA	15	50	2	42	310	50	360	With	B	XXMU16, WCMT06...
EVX16050RL	15	50	2	42	310	50	360	Without	B	XXMU16, WCMT06...
EVX16063RSA	15	63	2	42	190	50	240	With	B	XXMU16, WCMT06...
EVX16063RS	15	63	2	42	190	50	240	Without	B	XXMU16, WCMT06...
EVX16063RLA	15	63	2	42	310	50	360	With	B	XXMU16, WCMT06...
EVX16063RL	15	63	2	42	310	50	360	Without	B	XXMU16, WCMT06...

SPARE PARTS

Designation	Clamping screw 1	Clamping screw 2	Lubricant	Wrench 1	Wrench 2
EVX08016R...	-	CSPB-2.2	M-1000	IP-7D	-
EVX10020R...	-	CSPB-2.5	M-1000	IP-8D	-
EVX12025R...	-	CSPD-3	M-1000	IP-10D	-
EVX16032R...	CSPB-3.5	-	M-1000	IP-15D	-
EVX12040R...	-	CSPD-3	M-1000	IP-10D	-
EVX16050, 63R...	CSPB-3.5	CSTB-3.5D	M-1000	IP-15D	T-9D

Recommended clamping torque: CSPB-2.2 = 1 N·m, CSPB-2.5 = 1.3 N·m, CSPB-3.5 = 3.5 N·m, CSPD-3 = 2.5 N·m, CSTB-3.5D = 2.3 N·m

INSERT

XXMU-MJ

WCMT-D4

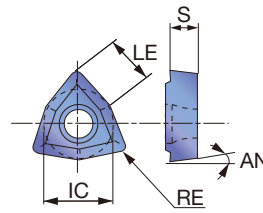
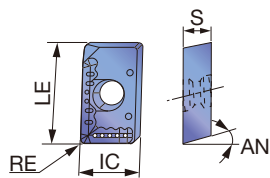

P	Steel	★	★					
M	Stainless	★		★				
K	Cast iron		★					
N	Non-ferrous							
S	Superalloys							
H	Hard materials	★						

★ : First choice
☆ : Second choice

Designation	RE	Coated			LE	IC	S	AN
		AH3135	AH120	AH140				
XXMU08T204PR-MJ	0.4	●	●	●	8.2	5.6	2.78	10°
XXMU10H308PR-MJ	0.8	●	●	●	10.6	6.8	3.5	11°
XXMU12X408PR-MJ	0.8	●	●	●	13.2	7.9	4.2	11°
XXMU16X508PR-MJ	0.8	●	●	●	16.8	11.1	5	11°
WCMT050308-D4	0.8		●	●	5.4	7.94	3.18	7°
WCMT06T308-D4	0.8		●	●	6.5	9.525	3.97	7°

● : Line up

STANDARD CUTTING CONDITIONS

Please scan below.

e-catalog



EVX

APPLICATION RANGE

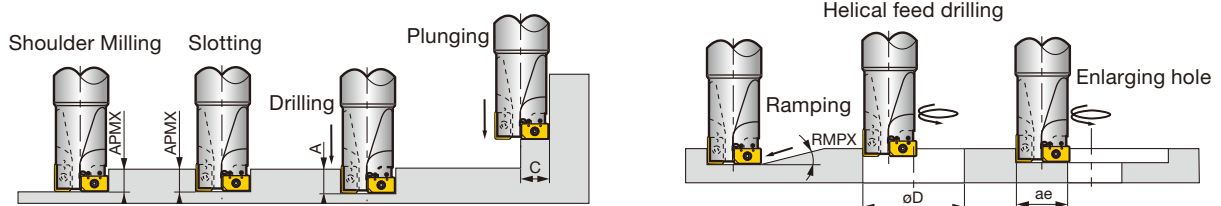

Designation	Tool dia. DC	Max. depth of cut APMX	Max. drilling depth A	Max. cutting width in plunging C	Max. ramping angle RMPX	Min. machining hole dia. øDmin	Max. machining hole dia. øDmax	Max. cutting width in enlarging hole ae
EVX08016R...	16	7	8	8	3°	19.2	30	14
EVX10020R...	20	9	10	10	3°	24	38	18
EVX12025R...	25	11.5	12.5	12.5	3°	30	48	23
EVX16032R...	32	15	16	16	3°	38.4	62	30
EVX12040RS/L (A)	40	11.5	20	20	3°	48	78	38
EVX16050RS/L (A)	50	15	25	25	3°	60	98	48
EVX16063RS/L (A)	63	15	31.5	31.5	3°	75.6	124	61





Z-FEEDMILL

TZP12

Plunge mill for roughing, with screw clamp system

GAMP = +26°, GAMF = -2°

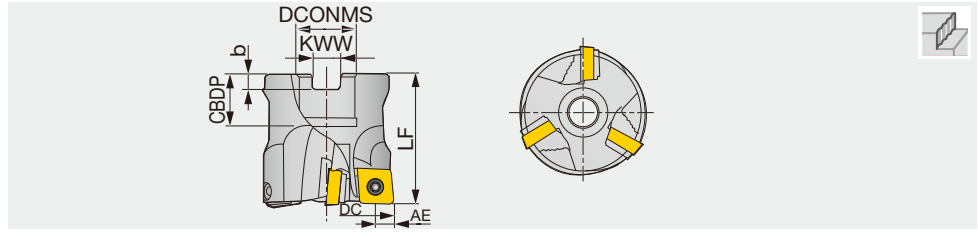

Designation	DC	CICT	DCONMS	CBDP	LF	b	KWW	WT(kg)	Insert
TZP12050R	50	3	22	20	50	6	10	0.38	APMT120416PR-MJ
TZP12050R-E	50	3	22	20	50	6.3	10.4	0.38	APMT120416PR-MJ
TZP12063R	63	3	22	20	50	6	10	0.72	APMT120416PR-MJ
TZP12063R-E	63	3	22	20	50	6.3	10.4	0.72	APMT120416PR-MJ
TZP12080R	80	4	31.75	32	63	8	12.7	1.51	APMT120416PR-MJ

SPARE PARTS

Designation	Clamping screw	Lubricant	Shim screw	Shim	Wewnch1	Wewnch2
TZP12	CSTB-3.5T	M-1000	DTS5-3.5SS	ZSA1102	T-20D	P-3.5

Recommended clamping torque: 5 N·m

INSERT

APMT120416-MJ

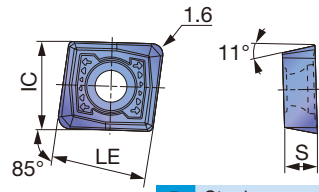

	P	M	K	N	S	H
Steel						☆ ★
Stainless						
Cast iron						★
Non-ferrous						
Superalloys						
Hard materials						

★ : First choice
☆ : Second choice

Designation	RE	AE	Coated		IC	LE	S
			AH120	T3130			
APMT120416PR-MJ	1.6	10	●	●	12.7	13.5	4.76

●: Line up

STANDARD CUTTING CONDITIONS

Please scan below.

e-catalog



TZP12

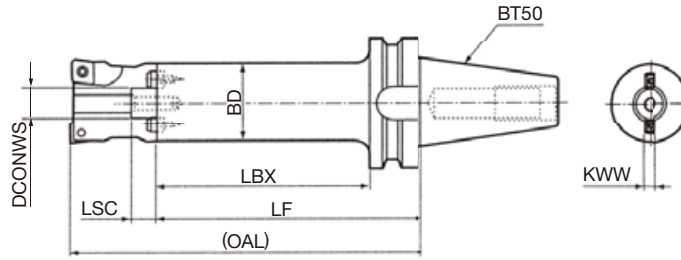

Designation	Dimension (mm)							WT (kg)	Applicable mill
	LF	LBX	(OAL)	BD	DCONWS	LSC	KWW		
BT50-FMC22-343-47	343	305	393	47	22	18	10	7.9	TZP12050R...
BT50-FMC22-293-47	293	255	343	47	22	18	10	7.2	TZP12050R...
BT50-FMC22-243-47	243	205	293	47	22	18	10	6.5	TZP12050R...
BT50-FMC22-433-59	433	395	483	59	22	18	10	12.2	TZP12063R...
BT50-FMC22-373-59	373	335	423	59	22	18	10	10.9	TZP12063R...
BT50-FMC22-308-59	308	270	358	59	22	18	10	9.5	TZP12063R...
BT50-FMA31.75-455-76	455	417	518	76	31.75	30	12.7	18.6	TZP12080R...
BT50-FMA31.75-375-76	375	337	438	76	31.75	30	12.7	15.8	TZP12080R...
BT50-FMA31.75-295-76	295	257	358	76	31.75	30	12.7	12.9	TZP12080R...

Note: (GL) is a length with TZP12 cutter mounted.

Grade
Insert
Ext. Toolholder
Int. Toolholder
Threading
Grooving
Miniature tool
Milling cutter
Endmill
Drilling tool
Tooling System
User's Guide
Index



- High Feed Milling
- Face Milling
- Shoulder Milling
- Slot Milling
- Profile Milling
- Chamfering, Counterbore
- Finish Face Milling
- Approach angle
- Others

TZP19

Plunge mill for roughing, with wedge clamp system

GAMP = +16°, GAMF = -2°

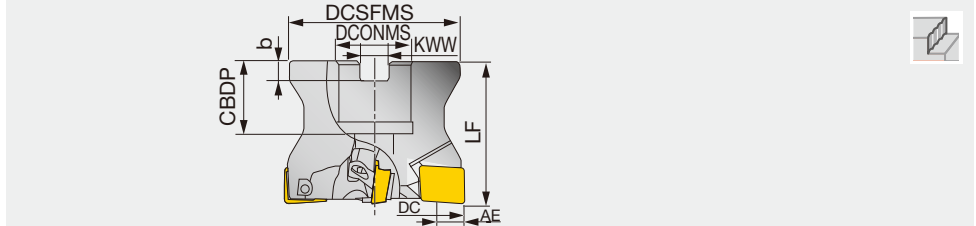

Designation	DC	CICT	DCSFMS	DCONMS	CBDP	LF	b	KWW	WT(kg)	Insert
TZP19080R	80	4	76	31.75	32	63	8	12.7	1.32	APMR190616PR-MJ
TZP19100R	100	5	96	31.75	32	63	8	12.7	2.41	APMR190616PR-MJ
TZP19125R	125	6	98	38.1	38	63	10	15.9	3.17	APMR190616PR-MJ

SPARE PARTS

Designation	Clamping screw	Adjusting screw	Shim	Wedge	Wewnch1	Wewnch 2
TZP19	CSTA-4	FDS-8ST	ZSA1502	WPP16R	T-15D	T-27T

Recommended clamping torque: 3.5 N·m

INSERT

APMR190616-MJ

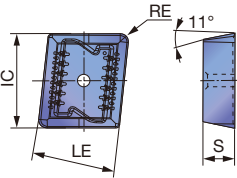

	P Steel	M Stainless	K Cast iron	N Non-ferrous	S Superalloys	H Hard materials
	☆	☆	☆	☆	☆	☆
	★	★	★	★	★	★

★ : First choice
☆ : Second choice

Designation	RE	AE	Coated		IC	LE	S
			AH120	T3130			
APMR190616PR-MJ	1.6	17	●	●	19.05	15.875	6.35

●: Line up

STANDARD CUTTING CONDITIONS

Please scan below.

e-catalog



TZP19

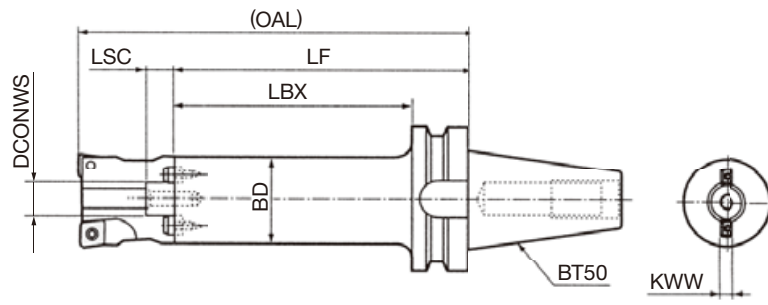

Designation	Dimension (mm)							WT (kg)	Applicable mill
	LF	LBX	(OAL)	BD	DCONWS	LSC	KWW		
BT50-FMA31.75-455-76	455	417	518	76	31.75	30	12.7	18.6	TZP19080R
BT50-FMA31.75-375-76	375	337	438	76	31.75	30	12.7	15.8	TZP19080R
BT50-FMA31.75-295-76	295	257	358	76	31.75	30	12.7	12.9	TZP19080R
BT50-FMA31.75-375-96	375	337	438	96	31.75	30	12.7	23	TZP19100R
BT50-FMA38.1-375-98	375	337	438	98	38.1	34	15.9	23.8	TZP19125R

Note: (GL) is a length with TZP19 cutter mounted.

Grade **A**

Insert **B**

Ext. Toolholder **C**

Int. Toolholder **D**

Threading **E**

Grooving **F**

Miniature tool **G**

Milling cutter **H**

Endmill **I**

Drilling tool **J**

Tooling System **K**

User's Guide **L**

Index **M**



TZF11

High precision plunge mill

GAMP = 0°, GAMF = -6° ~ 0°

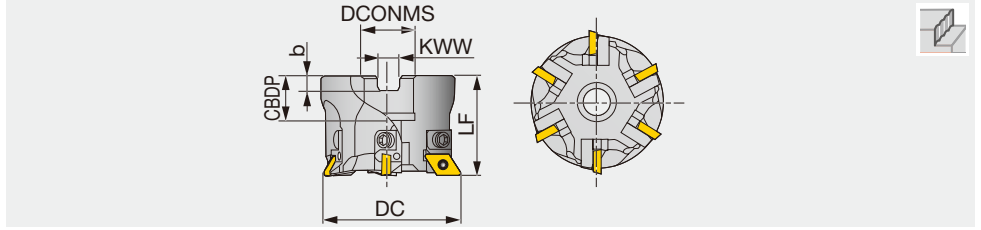

Designation	CICT	DC	DCONMS	CBDF	LF	b	KWW	WT(kg)	Insert
TZF11050R	4	50	22	20	45	6	10	0.38	DPCW11T3ZFR
TZF11050R-E	4	50	22	20	45	6.3	10.4	0.38	DPCW11T3ZFR
TZF11063R	6	63	22	20	45	6	10	0.72	DPCW11T3ZFR
TZF11063R-E	6	63	22	20	45	6.3	10.4	0.72	DPCW11T3ZFR
TZF11080R	7	80	31.75	32	63	8	12.7	1.51	DPCW11T3ZFR

SPARE PARTS

Designation	Clamping screw	Cartridge	Lubricant	Cartridge fixing screw	Cartridge fixing screw	Shell locking bolt	Wewnch	Wewnch 1	Wewnch 2
TZF11050R*	CSTB-4S	SDUPR09CZ-11	M-1000	CM4X0.7X12	SSHM3-10	FSHM10-40	T-15D	P-1.5	P-3
TZF11063R*, TZF11080R	CSTB-4S	SDUPR09CZ-11	M-1000	CM4X0.7X12	SSHM3-10	-	T-15D	P-1.5	P-3

Recommended clamping torque: 3.5 N·m

INSERT

DPCW11T3 (High precision ground insert for plunging)

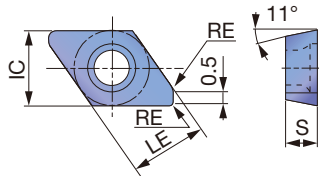

P	Steel	☆	★						
M	Stainless								
K	Cast iron	★	☆						
N	Non-ferrous								
S	Superalloys								
H	Hard materials	☆							

★ : First choice
☆ : Second choice

Designation	RE	Coated		Cermet	LE	IC	S
		AH120	AH740	NS740			
DPCW11T3ZFR	1	●	●	●	9.525	9.525	3.97

● : Line up

STANDARD CUTTING CONDITIONS

Please scan below.

e-catalog



ARBOR

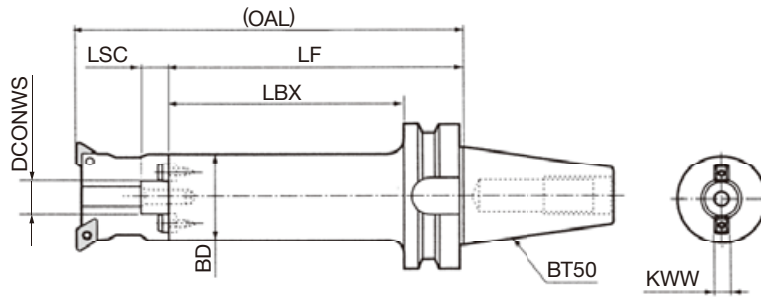

Designation	Dimension (mm)							WT (kg)	Applicable mill
	LF	LBX	(OAL)*	BD	DCONWS	LSC	KWW		
BT50-FMC22-343-47	343	305	388	47	22	18	10	7.9	TZF11050R...
BT50-FMC22-293-47	293	255	338	47	22	18	10	7.2	TZF11050R...
BT50-FMC22-243-47	243	205	288	47	22	18	10	6.5	TZF11050R...
BT50-FMC22-433-59	433	395	478	59	22	18	10	12.2	TZF11063R...
BT50-FMC22-373-59	373	335	418	59	22	18	10	10.9	TZF11063R...
BT50-FMC22-308-59	308	270	353	59	22	18	10	9.5	TZF11063R...
BT50-FMA31.75-455-76	455	417	518	76	31.75	30	12.7	18.6	TZF11080R...
BT50-FMA31.75-375-76	375	337	438	76	31.75	30	12.7	15.8	TZF11080R...
BT50-FMA31.75-295-76	295	257	358	76	31.75	30	12.7	12.9	TZF11080R...

Note: (OAL) is a length with TZF1 1 cutter mounted.

Grade
Insert
Ext. Toolholder
Int. Toolholder
Threading
Grooving
Miniature tool
Milling cutter
Endmill
Drilling tool
Tooling System
User's Guide
Index





High Feed Milling

NMS09

High precision finishing face mill

GAMP = 10°, GAMF = -30°



Face Milling

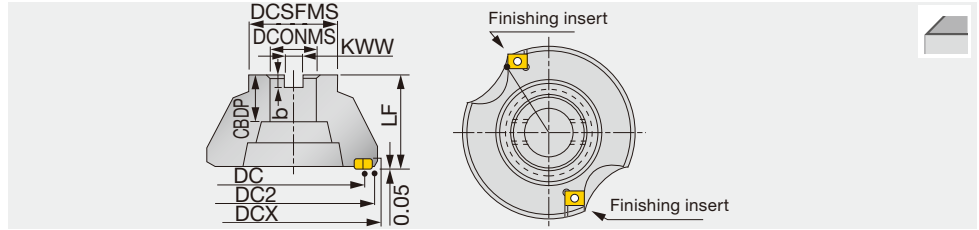

Shoulder Milling



Slot Milling



Profile Milling

Designation	APMX	DC	CICT	DC2	DCX	LF	DCONMS	CBDP	KWW	b	WT(kg)	Insert
NMS09080R	0.2	80	2	92	100.7	50	25.4	26	9.5	6	1.49	LNCQ0906...
NMS09100R	0.2	100	2	112	120.7	50	31.75	32	12.7	8	2.1	LNCQ0906...
NMS09125R	0.2	125	2	137	145.7	63	38.1	38	15.9	10	4.07	LNCQ0906...
NMS09160R	0.2	160	2	172	180.7	63	50.8	38	19	11	6.15	LNCQ0906...
NMS09200R	0.2	200	2	212	220.7	63	47.625	38	25.4	14	9.67	LNCQ0906...



Chamfering, Counterbore

EMS09

High precision finishing endmill, shank type

GAMP = +10°, GAMF = -30°



Finish Face Milling

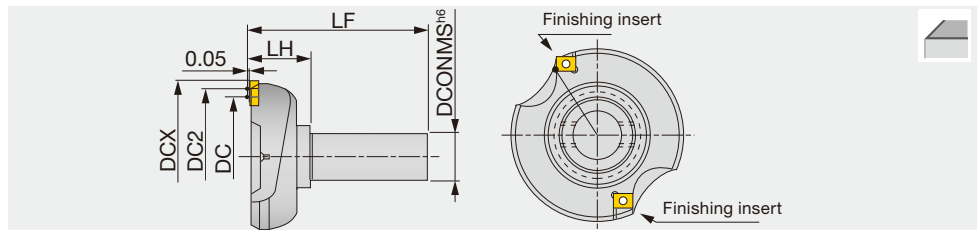

Designation	APMX	DC	CICT	DC2	DCX	DCONMS	LH	LF	Insert
EMS09080R	0.2	80	2	92	100.7	32	40	120	LNCQ0906...

Approach angle

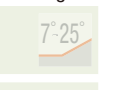

7°-25°

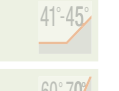

41°-45°

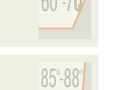

60°-70°

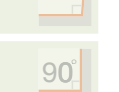

85°-88°

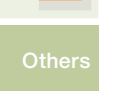

90°



Others

SPARE PARTS

Designation	Clamping screw	Wedge
NMS09..., EMS09080R	CSTB-4	T-15D

Recommended clamping torque: 3.5 N·m

INSERT

LNCQ0906N-100(50)L

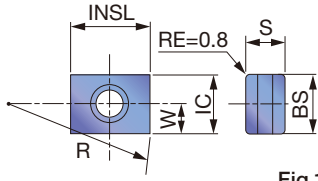

Fig.1

LNCQ0906-50S

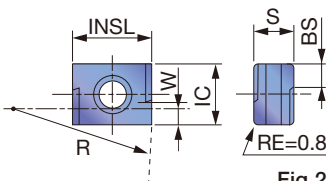

Fig.2

P Steel	☆		★		
M Stainless	★		★		
K Cast iron	★	★			
N Non-ferrous					
S Superalloys					
H Hard materials					

★ : First choice
☆ : Second choice

Designation	APMX	Coated		Cermet		IC	INSL	S	R	W	BS	Fig.
		AH120	GH110	NS740								
LNCQ0906N-100L	0.2	●	●	●		9.525	12.7	6.35	100	4.763	7.9	1
LNCQ0906N-50L	0.2	●	●	●		9.525	12.7	6.35	50	4.763	7.9	1
LNCQ0906R-50S	0.2	●	●	●		9.525	12.7	6.35	50	2.3	4	2

●: Line up

STANDARD CUTTING CONDITIONS

ISO	Workpiece material	Hardness (HB)	Grade	Cutting speed Vc (m/min)	LNCQ0906N-100(50)L		LNCQ0906R-50S	
					Depth of cut APMX (mm)	Feed per tooth f (mm/rev)	Depth of cut APMX (mm)	Feed per tooth f (mm/rev)
P	Mild steels SS400, etc. E275A, etc.	< 180	NS740	200 - 300	< 0.2	2 - 6	≤ 0.2	1 - 2.5
	Carbon steels S55C, etc. C55, etc.	< 300	NS740	150 - 250				
	Alloy steels SCM440, etc. 42CrMo4, etc.	< 300	NS740	120 - 200				
	Die steels SKD61, etc. X40CrMoV5-1, etc.	< 300	NS740	100 - 150				
M	Stainless steels SUS304, SUS316, etc. X5CrNi18-9, X5CrNiMo17-12-3, etc.	< 250	AH120 NS740	150 - 220	< 0.2	2 - 6	≤ 0.2	1 - 2.5
K	Cast irons FC250, etc. 250, etc.	150 - 250	GH110 AH120	120 - 200	< 0.2	2 - 6	≤ 0.2	1 - 2.5



MS

High precision finishing face mill

GAMP = -5°, GAMF = -30°

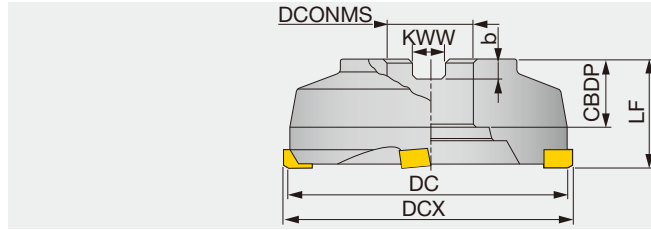

Right hand (R) shown.

Designation	APMX	DC	CICT	DCX	LF	DCONMS	CBDP	KWW	b	WT(kg)	Insert
MS04R/L	0.1	100	2	105	55	31.75	32	12.7	8	3	SN**56...
MS05R/L	0.1	125	2	130	60	38.1	38	15.9	10	4	SN**56...
MS06R/L	0.1	150	4	155	60	50.8	38	19	11	5	SN**56...
MS08R/L	0.1	200	4	205	60	47.625	38	25.4	14	8.5	SN**56...
MS10R/L	0.1	250	4	255	60	47.625	38	25.4	14	14	SN**56...
MS12R/L	0.1	300	4	305	60	47.625	38	25.4	14	23	SN**56...

SPARE PARTS

Designation	Clamping screw	Locator	Pin	Locator fixing screw	Washer	Protector	Wrench
MS04R/L	CST-5	-	SP-8	-	-	PMS4R/L	T-25D
MS05R/L, MS06R/L	CST-5	-	SP-8	-	-	PMS5R/L	T-25D
MS08R/L - MS12R/L	CST-5	LMS56R/L	SP-8	CM6x25, CM6x16	VA6	PMS5R/L	T-25D

Recommended clamping torque: 3.5 N·m

Arbor type

MS08, 10R/L

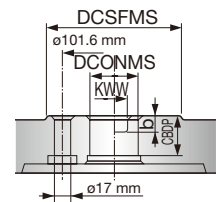

MS12R/L

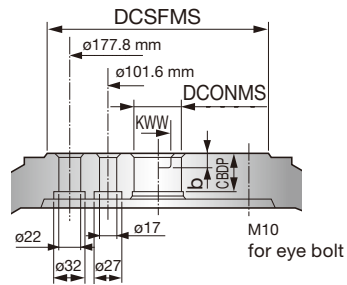

INSERT

SNAA56FTR

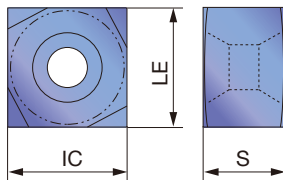

P Steel	★	
M Stainless		
K Cast iron		
N Non-ferrous		
S Superalloys		
H Hard materials	☆	

★ : First choice
☆ : Second choice

Designation	APMX	Cermet			LE	IC	S
		X407					
SNAA56FTR	0.1	●			7.85	15.875	9.52

● : Line up

STANDARD CUTTING CONDITIONS

ISO	Workpiece material	Hardness	Grade	Cutting speed V_c (m/min)	Feed per tooth f_z (mm/t)	Depth of cut APMX (mm)
P	Mild steels	< 180 HB	X407	260 - 300	≤ 6	≤ 0.1
	Carbon steels	< 300 HB	X407	120 - 180	≤ 6	≤ 0.1
	Alloy steels	< 300 HB	X407	120 - 180	≤ 6	≤ 0.1
	Die steels	< 30 HRC	X407	120 - 180	≤ 6	≤ 0.1
H	Carbon steel	40 - 50 HRC	X407	150 - 200	≤ 3	≤ 0.05

SFP4000R

High precision finishing face mill, with adjustable structure

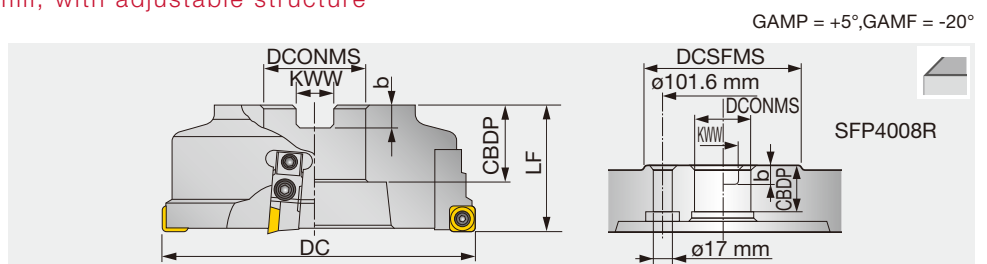

Designation	APMX	DC	CICT	LF	DCONMS	CBDP	KWW	b	WT(kg)	Insert
SFP4004R	0.1	100	2	63	31.75	32	12.7	8	2.3	SPHA435FNW
SFP4005R	0.1	125	2	63	38.1	38	15.9	10	3.5	SPHA435FNW
SFP4006R	0.1	160	4	63	50.8	38	19	11	5.8	SPHA435FNW
SFP4008R	0.1	200	4	63	47.625	38	25.4	14	9	SPHA435FNW
SFP4004R-E	0.1	100	2	63	32	32	14.4	8	2.3	SPHA435FNW
SFP4005R-E	0.1	125	2	63	40	32	16.4	9	3.5	SPHA435FNW
SFP4006R-E	0.1	160	4	63	40	29	16.4	9	5.8	SPHA435FNW

Arbor type

SFP4006R-E

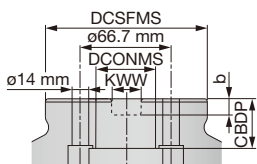

- High Feed Milling
- Face Milling
- Shoulder Milling
- Slot Milling
- Profile Milling
- Chamfering, Counterbore
- Finish Face Milling

EFP4000R

High precision finishing endmill, shank type, with adjustable structure

GAMP = +5°, GAMF = -20°

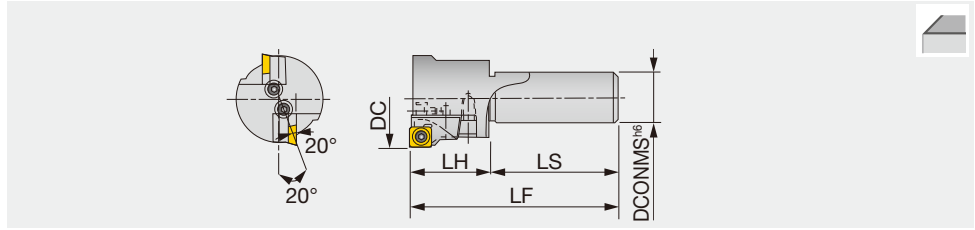

Designation	APMX	DC	CICT	DCONMS	LS	LF	LH	Insert
EFP4050R	0.1	50	1	32	80	120	40	SPHA435FNW
EFP4063R	0.1	63	2	32	80	130	50	SPHA435FNW

Note: EFP4050R does not have the adjustable structure.

SPARE PARTS

Designation	Clamping screw	Locator	Adjusting screw	Locator fixing screw1	Locator fixing screw2	Wedge	Wrench	Washer1	Washer2	Wrench
EFP4050R	CSTA-5S	LW402R	-	CM5X0.8X16	-	-	T-15D	-	-	-
SFP40..., EFP4063R	CSTA-5S	LW400R	FDS-8S	CM5X0.8X16	CM5X0.8X18	FW-305	T-15D	5S	L5	P-4

Recommended clamping torque: 3.5 N·m

INSERT

SPHA435

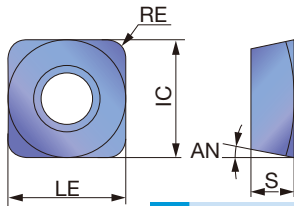

P	Steel	★							
M	Stainless	★							
K	Cast iron		★						
N	Non-ferrous		★						
S	Superalloys								
H	Hard materials								

★ : First choice
☆ : Second choice

Designation	RE	APMX	Cermets						
			N308	TH10	IC	LE	S	AN	
SPHA435FNW	2	0.1	●	●		12.7	12.7	4.76	11°

● : Line up

STANDARD CUTTING CONDITIONS

ISO	Workpiece material	Hardness (HB)	Grade	Cutting speed Vc (m/min)	Feed per revolution: f (mm/rev)		Depth of cut APMX (mm)
					SFP	EFP	
P	Mild steels	< 180	N308	180 - 250	≤ 6	≤ 4	≤ 0.1
	Carbon steels	< 300	N308	150 - 200	≤ 6	≤ 4	≤ 0.1
	Alloy steels	< 300	N308	150 - 200	≤ 6	≤ 4	≤ 0.1
M	Stainless steels	< 250	N308	160 - 200	≤ 4	≤ 3	≤ 0.1
K	Cast irons	150 - 250	TH10	100 - 150	≤ 5	≤ 3	≤ 0.2
N	Non-ferrous metals	-	TH10	200 - 500	≤ 6	≤ 4	≤ 0.1

Under the above conditions, attainable surface roughness is 3 to 4 μm RzJIS for steel and 6 to 12 μm RzJIS for cast iron.

Endmill



EndMill - Content structure

- Products are listed by application.
- Endmills in the catalog are our standard items.

How to use the page

Method 1.

Select the tool type at the index on the right page, choose the application (1), cutting edge shape (2), and the number of cutting edges (3), and check the designation you need (6) in the dimension table (5).

TUNGMEISTER
VEH...
4 flute, roughing - finishing, variable helix and pitch

1 2 3 4 5 6

Designation	AH715	AH725	NOF	FHA	DC	DCSfMS	APMX	RE	CRKS	LF	Wrench
VEH08L05.0P0504505	●	●	4	41°-45°	8	7.7	5	1	505	10	KEYV-505
VEH08L05.0P1004505	●	●	4	41°-45°	8	7.7	5	1	505	10	KEYV-505
VEH10L07.0P1004505	●	●	4	41°-45°	10	7.7	7	1	505	12.8	KEYV-505
VEH10L07.0P0504506	●	●	4	41°-45°	10	9.7	7	0.5	506	13	KEYV-506
VEH08L07.0P1004508	●	●	4	41°-45°	10	9.7	7	1	506	13	KEYV-506
VEH12L09.0P1004505	●	●	4	41°-45°	12	9.3	9	1	506	14.3	KEYV-506
VEH12L09.0P0504508	●	●	4	41°-45°	12	11.7	9	0.5	508	16.5	KEYV-508
VEH12L09.0P1004508	●	●	4	41°-45°	12	11.7	9	1	508	16.5	KEYV-508
VEH16L12.0P1004508	●	●	4	41°-45°	16	15.3	12	0.5	510	20.5	KEYV-510
VEH16L12.0P0504510	●	●	4	41°-45°	16	15.3	12	1	510	20.5	KEYV-510
VEH20L15.0P0504512	●	●	4	41°-45°	20	18.3	15	0.5	512	25.5	KEYV-512
VEH20L15.0P1004512	●	●	4	41°-45°	20	18.3	15	1	512	25.5	KEYV-512

VEH...
4 flute, roughing - finishing, long edge, variable helix and pitch

Designation	AH715	NOF	FHA	DC	DCSfMS	APMX	RE	CRKS	LF	Wrench
VEH08L12.0P0504505	●	4	41°-45°	8	7.7	12	0.5	505	18	KEYV
VEH08L12.0P1004505	●	4	41°-45°	8	7.7	12	1	505	18	KEYV
VEH10L15.0P0504506	●	4	41°-45°	10	9.7	15	0.5	506	22	KEYV
VEH10L15.0P1004506	●	4	41°-45°	10	9.7	15	1	506	22	KEYV
VEH20L18.0P0504508	●	4	41°-45°	12	11.7	18	0.5	508	27	KEYV

Method 2.

Select the tool series name on I004 – I005 and check the details on the product page.

Main products

Solid Endmill
SOLIDMEISTER I006 -
Solid endmill for a wide variety of applications
ø0.4 mm - ø25 mm

Exchangeable Head Endmill
TUNGMEISTER I060 -
Endmills with exchangeable heads
for reduced tool change time
ø5 mm - ø25 mm

I004 joss.si

Method 3.

Select the application and the cutting edge shape from Quick Guide on I006-I015 and I060 - I061, and see the details on each page.

Quick Guide SOLIDMEISTER

Edge shape	Name of file series	Designation	Appearance	Application	Tool diameter	No. of cutting edges
Square	VALVEGRINDING	TEC**H8M**CF-E		✓	ø6 - ø20	4
		TEC**EAL**CF		✓	ø1 - ø25	4
		TEC**EBL**CF		✓	ø6 - ø20	5
		TEC**H7-CF		✓	ø6 - ø20	7
		TEC**H**CF		✓	ø6 - ø20	6-20
		TECK**H4M**CF-R		✓	ø4 - ø20	4
		TECK**H7/9M**CF-R		✓	ø6 - ø20	7,9
		TEC**H4M**CF-R		✓	ø6 - ø25	4
		TEC**H4X**CF-R		✓	ø6 - ø20	4
		TECA**H3**CF-R		✓	ø1 - ø25	3
Pneumatic	VALVEGRINDING	TECA**H4**CF-R		✓	ø6 - ø16	4
		TECA**H3**CF-R**C		✓	ø6 - ø25	3
		TEPS**E44**CF		✓	ø6 - ø25	4
		TEPS**B44		✓	ø4 - ø25	4
		TECR**B**S		✓	ø5 - ø20	4, 5, 7
		TECR**B**M		✓	ø5 - ø20	4, 5, 7
		TECR**B**MF		✓	ø6 - ø25	4, 6
Pneumatic	VALVEGRINDING	TECR**B**L		✓	ø6 - ø20	4, 5, 7

I008 joss.si

Icon

Edge shape	No. of cutting edges	Head geometry	Application
Square	2	Square	Shoulder milling
Ball nose	3	Ball nose	Deep shoulder milling
High feed	4	Radius	Shoulder milling (with radius)
	5	Chamfering	Face milling
	6 or more	Slotting	Slotting
		Threading	Slotting (with radius)
			Side slotting
			Side milling
			Pocketing
			Ramping
			Profiling
			Plunging
			Hole enlarging
			Holmaking
			Counterboring
			Hole chamfering
			Chamfering
			Cutting-off

Main products

Solid Endmill



SOLIDMEISTER

Solid endmill for a wide variety of applications
ø0.4 mm - ø25 mm

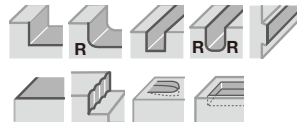

I006 -

P M K N S H

Exchangeable Head Endmill



TUNGMEISTER

Endmills with exchangeable heads
for reduced tool change time
ø5 mm - ø32 mm

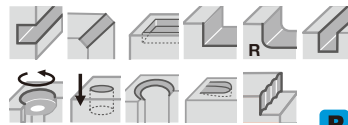

I060 -

P M K N S H

Threading Endmill

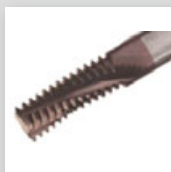

THREADMILLING

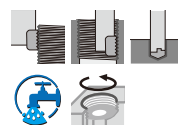

I106

P M K N S H



SOLIDTHREAD

Solid threading tool series for machining small diameters, such as M1x0.25 and 0-80UNF.

I107 -



TUNGMEISTER

Head-changeable milling tool for less down-time than solid tapping tools.

I060 -



Indexable thread milling cutter

Many different types of inserts for various threading diameters and pitches, leading to the tool integration and reduced tool cost.

I124 -

Grade
Insert
Ext. Toolholder
Int. Toolholder
Threading
Grooving
Miniature tool
Milling cutter
Endmill
Drilling tool
Tooling System
User's Guide
Index

A
B
C
D
E
F
G
H
I
J
K
L
M

SOLIDMEISTER



Powerful endmill with excellent performance

VARIABLEMEISTER

High resistance to chatter leading to highly efficient machining

- Suitable for machining large cutting depth and width where chattering is likely to occur.
- Capability of machining with long overhang allows the operations on various parts of workpieces.

Stable, long tool life

- Impacts on cutting edges are softened due to reduced vibration, resulting in longer, stable tool life.
- The combination of PVD coated grade with high wear resistance and robust substance.



High resistance to chatter
= Machining large cutting width
= Machining large cutting depth
/ long overhang



$\alpha_1 \neq \alpha_2$

FINISHMEISTER

Tool integration / Shortened tool change time

- Cutting depth at the level of roughing endmills is possible, and a single tool can handle semi-finishing to finishing with the conditions appropriately adjusted.
- A single tool completes the operation which used to require two tools, roughing and square endmills, shortening tool change time.

Hard to chatter, excellent chip control

- Variable pitch design increases the resistance to chatter, delivering high efficiency in machining with long overhang and at high cutting speed.
- Serrated cutting edges produce small chips and provide stable machining even in slotting.



Roughing and finishing with one tool
+ Variable pitch design



$\alpha_1 \neq \alpha_2$

SHREDMEISTER

Significantly reduced time for roughing

- Long cutting edge and the capability of machining large depth of cut lead to highly efficient roughing.
- Unique serrated cutting edges produce small chips and provide high efficiency and stability in deep slotting.

Excellent sharpness and stable machining with long tool life

- Chamfer on corner tips that are easy to break is reinforced, providing stable machining even under high cutting conditions.
- The combination of PVD coated grade with high wear resistance and robust substance allows the design with high helix angle, providing excellent sharpness and long tool life.



Effective cutting edge length
= Tool diameter x 2





AH725

- High thermal and chemical stability.
- High hardness 3500 HV makes higher speeds, machining of harder materials, and dry machining possible. The TiAlN coating can be applied at 800° C.
- Recommended for hardened steel, high-temperature and steel alloys.
- Improves and expedites finishing on dies and molds.
- Longer tool life in high speed machining.

AH750 / AH710

- Excellent for machining hard steel up to 70 HRC and high temperature alloys.
- The small grain size improves cutting edge strength and tends to chip less.

KS15F







- Suited for aluminum alloys and non-ferrous metals.
- Excellent edge sharpness for super mirror surface finish quality.

FX510



- Suitable for nickel-based heat-resistnt superalloys.
- SiAlON ceramic grade enables high speed milling.
- Also good for cast iron and specialty graphite materials.

Grade priorities for solid carbide endmills

In most cases the best performance can be attained without using coolant for specific grades. However, it should be noted that if for any reason coolant must be used, it could possibly affect tool life and sometimes cause insert failure, due to thermal shock.

	 ISO P	 ISO M	 ISO K	 ISO N	 ISO S	 ISO H
Material Groups	Steel	Stainless	Cast Iron	Non-ferrous	Superalloys	Hard Materials
	Harder ↑ AH750	Harder ↑	Harder ↑ AH750	Harder ↑	Harder ↑ AH750	Harder ↑ AH750
	AH725	AH725	AH725	AH725	AH725	AH725
	↓ Tougher	↓ Tougher	↓ Tougher	↓ Tougher	↓ Tougher	↓ Tougher
				↓ Tougher	↓ Tougher	↓ Tougher
				KS15F	KS15F	





Quick Guide **SOLIDMEISTER**

Edge shape	Name of the series	Designation	Appearance	Application			Tool diameter	No. of cutting edges		
				Finishing	Medium cutting	Roughing				
 Square	VARIABLEMEISTER	TEC**H4S/M**CF-E			✓	✓	ø6 - ø20	4		
		TEC**E4L**CF			✓	✓	ø1 - ø25	4		
		TEC**E5L**CF			✓	✓	ø6 - ø20	5		
		TEC**H7-CF		✓			ø6 - ø20	7		
		TEC**H**CF		✓			ø6 - ø20	6 - 20		
		TECK**H4M**CF-R			✓	✓	ø4 - ø20	4		
		TECK**H7/9M**CF-R			✓	✓	ø6 - ø20	7, 9		
		TEC**H4M**CF-R			✓	✓	ø6 - ø25	4		
		TEC**H4X**CF-R			✓	✓	ø6 - ø20	4		
		TECA**H3**CF-R			✓	✓	ø1 - ø25	3		
		TECA**H4**CF-R			✓	✓	ø6 - ø16	4		
		TECA**H3**CF-R**C			✓		ø6 - ø25	3		
		FINISHMEISTER	TEFS**E44**CF			✓	✓	ø6 - ø25	4	
			TEFS**B44			✓	✓	ø4 - ø25	4	
SHREDMEISTER	TECR**B*S				✓	ø5 - ø20	4, 5, 7			
	TECR**B*M				✓	ø5 - ø20	4, 5, 7			
	TECR**B*MF				✓	ø6 - ø25	4, 6			
	TECR**B*L				✓	ø6 - ø20	4, 5, 7			

★ : First choice ☆ : Second choice

	ap	Corner geometry	Helix angle	Pitch	Workpiece material						Remarks	Page
					P	M	K	N	S	H		
	1D, 2D	Chamfered/R	Variable	Variable	★	★	★	☆	☆	☆		I016
	2D	Chamfered/ Sharp edge	38	Variable	★	★	★	☆	☆	☆		I017
	2.5D	Chamfered	38	Variable	★	★	★	☆	★	☆		I017
	2D - 6D	Chamfered/ R/ Sharp edge	Variable	Variable	★	★	★	☆	☆	★		I018
	2D	Chamfered	Variable	Variable	★	★	☆	☆	☆	☆		I019
	2D	R	Variable	Variable	★	★	☆	☆	★	☆		I019
	2D	R	Variable	Variable	★	★	☆	☆	★	☆		I020
	2D	R	Variable	Variable	★	★	☆	☆	★	★		I020
	2D	R	Variable	Variable	★	★	☆	☆	★	☆		I021
	1.5D, 2D	R	Variable	Variable	☆	☆	☆	★	☆	☆		I022 - I023
	1.5D, 2D	R	Variable	Variable	☆	☆	☆	★	☆	☆		I024
	2D	R	Variable	Variable	☆	☆	☆	★	☆	☆		I024
	2D	Chamfered	38	Variable	★	☆	★	☆	☆	☆	Rough/Finish combination geometry	I026
	2D	Chamfered	45	Regular	★	★	☆	☆	★	☆	Rough/Finish combination geometry	I027
	1D	Chamfered	45	Regular	★	☆	★	☆	☆	★	Serrated cutting edge	I027
	2D	Chamfered/R	45	Regular	★	☆	★	☆	☆	★	Serrated cutting edge	I028
	2D	Chamfered	45	Regular	★	☆	☆	☆	★	★	Serrated cutting edge	I028
	2D	Chamfered	45	Regular	★	☆	★	☆	☆	★	Serrated cutting edge	I029

Quick Guide **SOLIDMEISTER**

Edge shape	Name of the series	Designation	Appearance	Application			Tool diameter	No. of cutting edges	
				Finishing	Medium cutting	Roughing			
 Square	SHREDMEISTER	TECR**B*X				✓	ø8 - ø16	4, 5	
		TERF**A/E3,4				✓	ø4 - ø20	3, 4	
		TECR**T4M				✓	ø6 - ø20	4	
		TECP**E*3/4L				✓	ø5 - ø20	3, 4	
		TEAP**H3**CFR**C				✓	ø10 - ø20	3	
		TERC**E3				✓	ø6 - ø25	3	
		TECR**B3**R				✓	ø6 - ø20	3	
	TEC**B4/6L			✓			ø6 - ø20	4, 6	
	TEC**B4/6X			✓			ø10 - ø20	4, 6	
	TECC**A/B2			✓	✓	✓	ø2 - ø20	2	
	TECS/TECCS**E3			✓	✓	✓	ø2 - ø16	3	
	TECC**E3			✓	✓	✓	ø4 - ø20	3	
	TEC**B3				✓	✓	ø6 - ø18	3	
	TECC**A/B4			✓	✓	✓	ø2 - ø20	4	
	TEC**B4			✓	✓		ø2 - ø20	4	
	TEC**B4**R			✓	✓		ø6 - ø20	4	
	TEC**A2					✓	ø0.4 - ø3	2	
	TEC**A4					✓	ø4 - ø20	4	

★ : First choice ☆ : Second choice

	ap	Corner geometry	Helix angle	Pitch	Workpiece material						Remarks	Page
					P	M	K	N	S	H		
	1.5D	Chamfered	45	Regular	★	☆	★	☆	☆	★	Serrated cutting edge	1029
	2D	Chamfered	30/38	Regular	★	★	★	☆	☆	★	Serrated cutting edge	1029
	2D	Chamfered	20	Regular	★	☆	★	☆	☆	★	Serrated cutting edge	1030
	2D	Chamfered	38	Regular	★	☆	★	☆	☆	★	Serrated cutting edge	1030
	1.5D, 2D	R	Variable	Variable	☆	☆	☆	★	☆	☆	Notched cutting edge	1031
	2D	Chamfered	38	Regular	☆	☆	☆	★	☆	☆	Serrated cutting edge	1031
	1D	R	45	Regular	☆	☆	☆	★	☆	☆	Serrated cutting edge	1032
	3D, 4D	Sharp edge	45	Regular	★	★	★	☆	☆	☆		1034
	4D, 5D, 6D	Sharp edge	45	Regular	★	★	★	☆	☆	☆		1034
	2D, 3D	Chamfered	30/45	Regular	★	★	★	☆	☆	☆		1035
	1D	Chamfered	38	Regular	★	★	★	☆	☆	☆		1035
	2D, 3D	Chamfered	38	Regular	★	★	★	☆	☆	☆		1036
	2D	Sharp edge	45	Regular	★	★	★	☆	☆	☆		1036
	2D	Chamfered	30/45	Regular	★	★	★	☆	☆	☆		1036
	2D, 3D	Sharp edge	45	Regular	★	★	★	☆	☆	☆		1037
	2D	Sharp edge	45	Regular	★	★	★	☆	☆	☆		1037
	1.5D	Sharp edge	30	Regular	★	☆	★	☆	☆	★		1038 - 1039
	2D	Sharp edge	30	Regular	★	☆	★	☆	☆	★		1039

Quick Guide **SOLIDMEISTER**

Edge shape	Name of the series	Designation	Appearance	Application			Tool diameter	No. of cutting edges	
				Finishing	Medium cutting	Roughing			
 Square	SOLIDMEISTER	TECH**B6			✓		ø6 - ø20	6	
		TEC**B6			✓		ø6 - ø25	6	
		TEC**D6		✓			ø6 - ø20	6	
		TECA**B2		✓			ø4 - ø20	2	
		TECA**B3			✓	✓	ø4 - ø20	3	
		TECA**F2		✓			ø4 - ø25	2	
	ECOMEISTER	TEC**A2**E			✓		ø1 - ø20	2	
		TEC**A/E3**E			✓		ø2 - ø16	3	
		TEC**B3**W			✓		ø2 - ø20	3	
		TEC**A4**E			✓		ø2 - ø20	4	
 Ball	VARIABLEMEISTER	TEB**E4L**CF			✓	✓	ø3 - ø16	4	
	SHREDMEISTER	TEBRF**T3/4				✓	ø6 - ø20	3, 4	
	SOLIDMEISTER	TEB**A2-**C**M		✓	✓		ø0.4 - ø3	2	
		TEB**A2-**C**H		✓	✓		ø1 - ø20	2	
		TEB**A2-**C**M...		✓	✓		ø3 - ø16	2	

★ : First choice ☆ : Second choice

	ap	Corner geometry	Helix angle	Pitch	Workpiece material						Remarks	Page
					P	M	K	N	S	H		
	2D	Sharp edge	45	Regular	★	☆	★	☆	☆	★		I040
	4D	Sharp edge	45	Regular	★	☆	★	☆	☆	★		I040
	2D	Sharp edge	50	Regular	★	☆	★	☆	☆	★		I041
	2D, 3D	Sharp edge	45	Regular	☆	☆	☆	★	☆	☆		I041
	2D	R	45	Regular	☆	☆	☆	★	☆	☆		I042
	2D	Sharp edge	55	Regular	☆	☆	☆	★	☆	☆		I042
	1D, 1.5D, 2D, 3D, 4D	Sharp edge	30	Regular	★	★	★	☆	☆	☆		I043
	1D, 1.5D, 2D, 3D, 4D	Sharp edge	30/38	Regular	★	★	★	☆	☆	☆		I044
	1D	Sharp edge	45	Regular	★	★	★	☆	☆	☆		I045
	2D, 3D, 4D, 5D, 6D, 8D, 10D	Sharp edge	30	Regular	★	★	★	☆	☆	☆		I045- I046
	2D	R1.5 - R8	38	Variable	★	★	☆	☆	★	★		I048
	2D	R3 - R10	20	Regular	★	★	★	☆	☆	★	Serrated cutting edge	I048
	1.5D	R0.2 - R1.5	30	Regular	★	★	☆	☆	★	★		I049
	1D	R0.5 - R10	30	Regular	★	★	☆	☆	★	★		I050
	2D	R1.5 - R8	30	Regular	★	★	☆	☆	★	★		I050

Quick Guide **SOLIDMEISTER**

Edge shape	Name of the series	Designation	Appearance	Application			Tool diameter	No. of cutting edges	
				Finishing	Medium cutting	Roughing			
 Ball	SOLIDMEISTER	TEB**A2**/**/**C**M...		✓	✓		ø1 - ø10	2	
		TEB**A2**-**C**-...		✓	✓		ø3 - ø20	2	
		TEB**A3		✓	✓		ø3 - ø12	3	
		TEB**A4		✓	✓		ø3 - ø20	4	
	TEB**A2**E		✓	✓		ø2 - ø20	2		
 High feed	FEEDMEISTER	TEFF**N4				✓	ø6 - ø20	4	
		TCFF**A3				✓	ø4 - ø20	3	
Toroidal	SOLIDMEISTER	TETR**A2**R				✓	ø2 - ø6	2	

★ : First choice ☆ : Second choice

	ap	Corner geometry	Helix angle	Pitch	Workpiece material						Remarks	Page
					P	M	K	N	S	H		
	2D	R0.5 - R5	30	Regular	★	★	☆	☆	★	★	Tapered ball nose	I051
	1D, 1.5D	R1.5 - R10	30	Regular	★	★	☆	☆	★	★		I051
	1D, 1.5D	R1.5 - R6	30	Regular	★	★	☆	☆	★	★		I051
	1D, 1.5D	R1.5 - R10	30	Regular	★	★	☆	☆	★	★		I052
	1D, 1.5D, 2D, 3D	R1 - R10	30	Regular	★	★	☆	☆	★	★		I052
	0.05D	R	-	Regular	★	★	☆	☆	★	★	For high feed milling	I055
	0.04D-0.05D	R	-	Regular			☆	☆	★		For high feed milling (ceramic grade)	I055
	0.5D, 1D	R	-	Regular	★	★	☆	☆	★	★		I056

VARIABLE MEISTER

TEC**H4S**CF-E

4 flute chatter dampening endmill, variable helix and variable pitch, short type

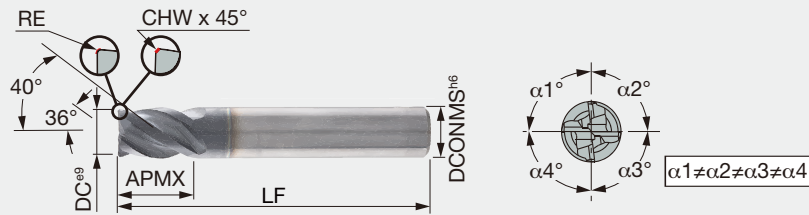

Designation	AH725	DC	DCONMS	NOF	CHW	RE	APMX	LF	Shank
TEC060H4S-06C06CF-E50	●	6	6	4	0.25	-	6	50	Cylindrical
TEC060H4S-06C06CF-R02E50	●	6	6	4	-	0.2	6	50	Cylindrical
TEC060H4S-06W06CF-E50	●	6	6	4	0.25	-	6	50	Weldon
TEC080H4S-08C08CF-E63	●	8	8	4	0.3	-	8	63	Cylindrical
TEC080H4S-08C08CF-R04E63	●	8	8	4	-	0.4	8	63	Cylindrical
TEC080H4S-08W08CF-E63	●	8	8	4	0.3	-	8	63	Weldon
TEC100H4S-10C10CF-E66	●	10	10	4	0.4	-	10	66	Cylindrical
TEC100H4S-10C10CFR.5E66	●	10	10	4	-	0.5	10	66	Cylindrical
TEC100H4S-10W10CF-E66	●	10	10	4	0.4	-	10	66	Weldon
TEC120H4S-12C12CF-E73	●	12	12	4	0.5	-	12	73	Cylindrical
TEC120H4S-12C12CF-R06E73	●	12	12	4	-	0.6	12	73	Cylindrical
TEC120H4S-12W12CF-E73	●	12	12	4	0.5	-	12	73	Weldon
TEC160H4S-16C16CF-E82	●	16	16	4	0.6	-	16	82	Cylindrical
TEC160H4S-16W16CF-E82	●	16	16	4	0.6	-	16	82	Weldon
TEC200H4S-20C20CF-E92	●	20	20	4	0.6	-	20	92	Cylindrical
TEC200H4S-20W20CF-E92	●	20	20	4	0.6	-	20	92	Weldon

● : Line up

TEC**H4M**CF-E

4 flute chatter dampening endmill, variable helix and variable pitch

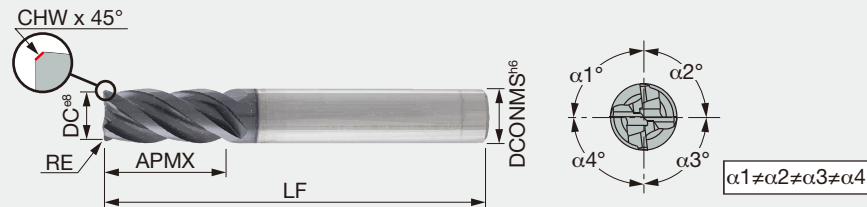

Designation	AH725	DC	DCONMS	NOF	CHW	APMX	LF	Shank
TEC060H4M-12C06CF-E57	●	6	6	4	0.25	12	57	Cylindrical
TEC060H4M-12W06CF-E57	●	6	6	4	0.25	12	57	Weldon
TEC080H4M-16C08CF-E63	●	8	8	4	0.3	16	63	Cylindrical
TEC080H4M-16W08CF-E63	●	8	8	4	0.3	16	63	Weldon
TEC100H4M-20C10CF-E72	●	10	10	4	0.4	20	72	Cylindrical
TEC100H4M-20W10CF-E72	●	10	10	4	0.4	20	72	Weldon
TEC120H4M-24C12CF-E83	●	12	12	4	0.5	24	83	Cylindrical
TEC120H4M-24W12CF-E83	●	12	12	4	0.5	24	83	Weldon
TEC160H4M-32C16CF-E92	●	16	16	4	0.6	32	92	Cylindrical
TEC160H4M-32W16CF-E92	●	16	16	4	0.6	32	92	Weldon
TEC200H4M-40C20CF-E104	●	20	20	4	0.6	40	104	Cylindrical
TEC200H4M-40W20CF-E104	●	20	20	4	0.6	40	104	Weldon

● : Line up

Reference pages: Standard cutting conditions → [I025](#)

TEC**E4L**CF

4 flute chatter dampening endmill, 38° helix angle, variable pitch, short type

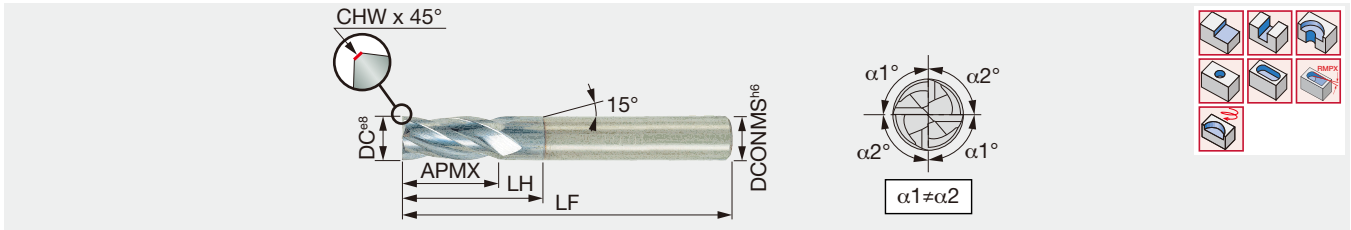

Designation	AH725	DC	DCONMS	NOF	CHW	APMX	LH	LF	Shank
TEC010E4L-2/04C04CF50	●	1	4	4	0.04	2.2	4	50	Cylindrical
TEC020E4L-4/06C04CF50	●	2	4	4	0.08	4.3	6.1	50	Cylindrical
TEC030E4L-8/11C06CF-57	●	3	6	4	0.1	8	11	57	Cylindrical
TEC040E4L-10/14C06CF-57	●	4	6	4	0.15	10	14	57	Cylindrical
TEC050E4L-12/17C06CF-57	●	5	6	4	0.18	12	17	57	Cylindrical
TEC060E4L-14/20C06CF-57	●	6	6	4	0.25	14	20	57	Cylindrical
TEC080E4L-18/26C08CFS63	●	8	8	4	-	18	26	63	Cylindrical
TEC080E4L-18/26C08CF-63	●	8	8	4	0.3	18	26	63	Cylindrical
TEC080E4L-18/26W08CF63	●	8	8	4	0.3	18	26	63	Weldon
TEC100E4L-22/32C10CFS72	●	10	10	4	-	22	32	72	Cylindrical
TEC100E4L-22/32C10CF-72	●	10	10	4	0.4	22	32	72	Cylindrical
TEC100E4L-22/32W10CF72	●	10	10	4	0.4	22	32	72	Weldon
TEC120E4L-26/38C12CFS83	●	12	12	4	-	26	38	83	Cylindrical
TEC120E4L-26/38C12CF-83	●	12	12	4	0.5	26	38	83	Cylindrical
TEC120E4L-26/38W12CF83	●	12	12	4	0.5	26	38	83	Weldon
TEC160E4L-34/50C16CF-100	●	16	16	4	0.6	34	50	100	Cylindrical
TEC160E4L-34/50W16CF-100	●	16	16	4	0.6	34	50	100	Weldon
TEC200E4L-42/60C20CF-110	●	20	20	4	0.6	42	60	110	Cylindrical
TEC200E4L-42/60W20CF-110	●	20	20	4	0.6	42	60	110	Weldon
TEC250E4L-50/65C25CF-121	●	25	25	4	0.6	50	65	121	Cylindrical
TEC250E4L-50/65W25CF121	●	25	25	4	0.6	50	65	121	Weldon

● : Line up

TEC**E5L**CF

5 flute chatter dampening endmill, 38° helix angle, variable pitch

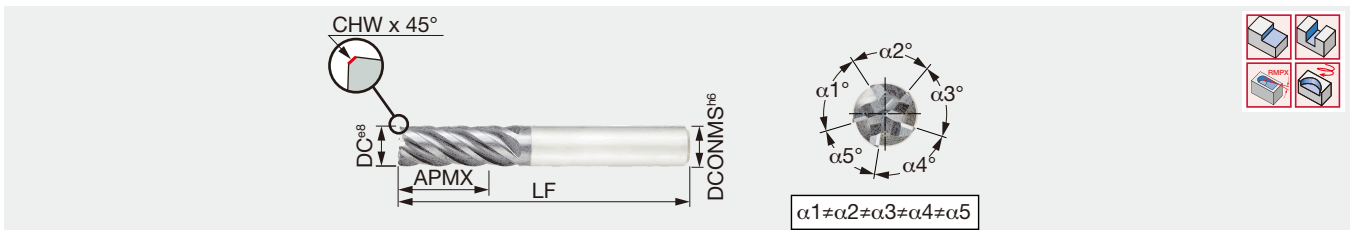

Designation	AH725	DC	DCONMS	NOF	CHW	APMX	LF	Shank
TEC060E5L-15C06CF-57	●	6	6	5	0.2	15	57	Cylindrical
TEC080E5L-20C08CF-63	●	8	8	5	0.25	20	63	Cylindrical
TEC100E5L-25C10CF-72	●	10	10	5	0.3	25	72	Cylindrical
TEC120E5L-30C12CF-83	●	12	12	5	0.4	30	83	Cylindrical
TEC160E5L-40C16CF-100	●	16	16	5	0.5	40	100	Cylindrical
TEC200E5L-50C20CF-125	●	20	20	5	0.5	50	125	Cylindrical

● : Line up

Reference pages: Standard cutting conditions → [I025](#)

7 flute chatter dampening endmill, variable helix and variable pitch, for high speed finishing

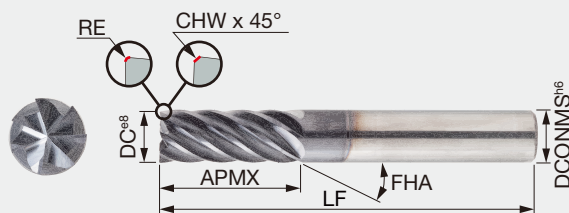

Designation	AH710	DC	DCONMS	NOF	RE	CHW	APMX	FHA	LF	Shank
TEC060H7-12C06CF-M57	●	6	6	7	-	-	12	37°	57	Cylindrical
TEC060H7-12C06CF-R02M57	●	6	6	7	0.2	-	12	37°	57	Cylindrical
TEC060H7-18C06CF-M65	●	6	6	7	-	0.2	18	37°	65	Cylindrical
TEC060H7-24C06CF-70	●	6	6	7	-	0.2	24	37°	70	Cylindrical
TEC060H7-36C06CF-90	●	6	6	7	-	0.2	36	37°	90	Cylindrical
TEC080H7-16C08CF-M63	●	8	8	7	-	-	16	37°	63	Cylindrical
TEC080H7-16C08CF-R04M63	●	8	8	7	0.4	-	16	37°	63	Cylindrical
TEC080H7-24C08CF-M90	●	8	8	7	-	0.2	24	37°	90	Cylindrical
TEC080H7-32C08CF-90	●	8	8	7	-	0.2	32	37°	90	Cylindrical
TEC080H7-48C08CF-110	●	8	8	7	-	0.2	48	37°	110	Cylindrical
TEC100H7-20C10CF-M72	●	10	10	7	-	-	20	37°	72	Cylindrical
TEC100H7-20C10CF-R05M72	●	10	10	7	0.5	-	20	37°	72	Cylindrical
TEC100H7-20W10CF-M72	●	10	10	7	-	-	20	37°	72	Weldon
TEC100H7-30C10CF-M85	●	10	10	7	-	0.3	30	37°	85	Cylindrical
TEC100H7-40C10CF-100	●	10	10	7	-	0.3	40	37°	100	Cylindrical
TEC100H7-60C10CF-130	●	10	10	7	-	0.3	60	37°	130	Cylindrical
TEC120H7-24C12CF-M83	●	12	12	7	-	-	24	37°	83	Cylindrical
TEC120H7-24C12CF-R06M83	●	12	12	7	0.6	-	24	37°	83	Cylindrical
TEC120H7-24W12CF-M83	●	12	12	7	-	-	24	37°	83	Weldon
TEC120H7-36C12CF-M95	●	12	12	7	-	0.3	36	37°	95	Cylindrical
TEC120H7-48C12CF-110	●	12	12	7	-	0.3	48	37°	110	Cylindrical
TEC120H7-72C12CF-140	●	12	12	7	-	0.3	72	37°	140	Cylindrical
TEC160H7-32C16CF-M92	●	16	16	7	-	-	32	37°	92	Cylindrical
TEC160H7-32C16CF-R08M92	●	16	16	7	0.8	-	32	37°	92	Cylindrical
TEC160H7-32W16CF-M92	●	16	16	7	-	-	32	37°	92	Weldon
TEC160H7-48C12CF-M110	●	16	16	7	-	0.3	48	37°	110	Cylindrical
TEC160H7-64C16CF-131	●	16	16	7	-	0.3	64	37°	131	Cylindrical
TEC160H7-96C16CF-175	●	16	16	7	-	0.3	96	37°	175	Cylindrical
TEC200H7-40C20CF-M104	●	20	20	7	-	-	40	37°	104	Cylindrical
TEC200H7-40C20CF-R10M104	●	20	20	7	1	-	40	37°	104	Cylindrical
TEC200H7-40W20CF-M104	●	20	20	7	-	-	40	37°	104	Weldon
TEC200H7-60C20CF-M140	●	20	20	7	-	0.4	60	37°	140	Cylindrical
TEC200H7-80C20CF-140	●	20	20	7	-	0.4	80	37°	140	Cylindrical

● : Line up

P

M

K

N

S

H

Reference pages: Standard cutting conditions → **I025**

TEC**H**CF

6 - 20 flute chatter dampening endmill, variable helix and variable pitch, for high speed finishing



Designation	AH710	DC	DCONMS	NOF	CHW	APMX	LF	Shank
TEC060H6-12C06CF-H57	●	6	6	6	0.2	12	57	Cylindrical
TEC080H8-16C08CF-H63	●	8	8	8	0.2	16	63	Cylindrical
TEC100H10-20C10CF-H72	●	10	10	10	0.3	20	72	Cylindrical
TEC120H12-24C12CF-H83	●	12	12	12	0.3	24	83	Cylindrical
TEC160H16-32C16CF-H92	●	16	16	16	0.3	32	92	Cylindrical
TEC200H20-40C20CFH104	●	20	20	20	0.4	40	104	Cylindrical

● : Line up

TECK**H4M**CF-R

4 flute chatter dampening endmill, variable helix and variable pitch, for titanium machining

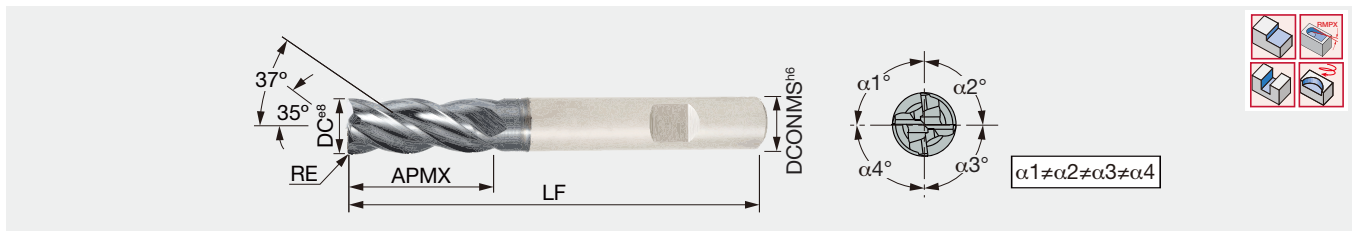

Designation	AH725	DC	DCONMS	NOF	RE	APMX	RMPX	LF	Shank
TECK040H4M-08C06CF-R02	●	4	6	4	0.2	8	5°	57	Cylindrical
TECK050H4M-10C06CF-R02	●	5	6	4	0.2	10	5°	57	Cylindrical
TECK060H4M-12C06CF-R02	●	6	6	4	0.2	12	5°	57	Cylindrical
TECK060H4M-12W06CF-R02	●	6	6	4	0.2	12	5°	57	Weldon
TECK080H4M-16C08CF-R04	●	8	8	4	0.4	16	5°	63	Cylindrical
TECK080H4M-16W08CF-R04	●	8	8	4	0.4	16	5°	63	Weldon
TECK100H4M-20C10CF-R05	●	10	10	4	0.5	20	5°	72	Cylindrical
TECK100H4M-20W10CF-R05	●	10	10	4	0.5	20	5°	72	Weldon
TECK120H4M-24C12CF-R06	●	12	12	4	0.6	24	5°	83	Cylindrical
TECK120H4M-24W12CF-R06	●	12	12	4	0.6	24	5°	83	Weldon
TECK160H4M-32C16CF-R08	●	16	16	4	0.8	32	5°	92	Cylindrical
TECK160H4M-32W16CF-R08	●	16	16	4	0.8	32	5°	92	Weldon
TECK200H4M-40C20CF-R10	●	20	20	4	1	40	5°	104	Cylindrical
TECK200H4M-40W20CF-R10	●	20	20	4	1	40	5°	104	Weldon

● : Line up

Reference pages: Standard cutting conditions → [I025](#)

VARIABLE MEISTER

TECK**H7/9M**CF-R

7 - 9 flute chatter dampening endmill, variable helix and variable pitch, for titanium machining

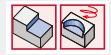
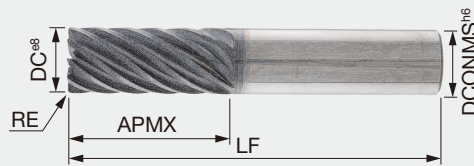

Designation	AH725	DC	DCONMS	NOF	RE	APMX	RMPX	LF	Shank
TECK060H7-13C06CF-R02T57	●	6	6	7	0.2	13	5°	57	Cylindrical
TECK060H7-13W06CF-R02T57	●	6	6	7	0.2	13	5°	57	Weldon
TECK080H7-19C08CF-R04T63	●	8	8	7	0.4	19	5°	63	Cylindrical
TECK080H7-19W08CF-R04T63	●	8	8	7	0.4	19	5°	63	Weldon
TECK100H7-22C10CF-R05T72	●	10	10	7	0.5	22	5°	72	Cylindrical
TECK100H7-22W10CF-R05T72	●	10	10	7	0.5	22	5°	72	Weldon
TECK120H7-26C12CF-R06T83	●	12	12	7	0.6	26	5°	83	Cylindrical
TECK120H7-26W12CF-R06T83	●	12	12	7	0.6	26	5°	83	Weldon
TECK160H9-32C16CF-R08T92	●	16	16	9	0.8	32	5°	92	Cylindrical
TECK160H9-32W16CF-R08T92	●	16	16	9	0.8	32	5°	92	Weldon
TECK200H9-38C20CF-R10T104	●	20	20	9	1	38	5°	104	Cylindrical
TECK200H9-38W20CF-R10T104	●	20	20	9	1	38	5°	104	Weldon

● : Line up

TEC**H4M**CF-R

4 flute chatter dampening endmill, variable helix and variable pitch

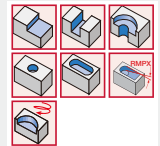
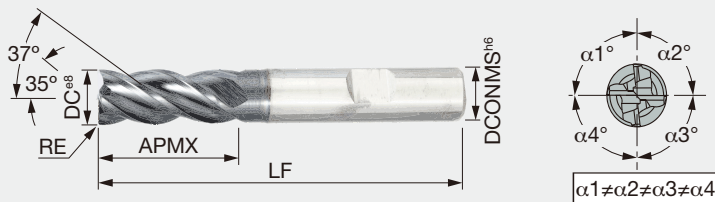

Designation	AH725	DC	DCONMS	NOF	RE	APMX	RMPX	LF	Shank
TEC060H4M-12C06CF-R02-57	●	6	6	4	0.2	12	5°	57	Cylindrical
TEC060H4M-12W06CF-R02-57	●	6	6	4	0.2	12	5°	57	Weldon
TEC080H4M-16C08CF-R04-63	●	8	8	4	0.4	16	5°	63	Cylindrical
TEC080H4M-16W08CF-R04-63	●	8	8	4	0.4	16	5°	63	Weldon
TEC100H4M-20C10CF-R05-72	●	10	10	4	0.5	20	5°	72	Cylindrical
TEC100H4M-20W10CF-R05-72	●	10	10	4	0.5	20	5°	72	Weldon
TEC120H4M-24C12CF-R06-83	●	12	12	4	0.6	24	5°	83	Cylindrical
TEC120H4M-24W12CF-R06-83	●	12	12	4	0.6	24	5°	83	Weldon
TEC140H4M-28C14CFR0.7-83	●	14	14	4	0.7	28	5°	83	Cylindrical
TEC140H4M-28W14CFR0.7-83	●	14	14	4	0.7	28	5°	83	Weldon
TEC160H4M-32C16CF-R08-92	●	16	16	4	0.8	32	5°	92	Cylindrical
TEC160H4M-32W16CF-R08-92	●	16	16	4	0.8	32	5°	92	Weldon
TEC200H4M-40C20CF-R10-104	●	20	20	4	1	40	5°	104	Cylindrical
TEC200H4M-40W20CF-R10-104	●	20	20	4	1	40	5°	104	Weldon
TEC250H4M-50C25CF-R12-121	●	25	25	4	1.2	50	5°	121	Cylindrical
TEC250H4M-50W25CF-R12-121	●	25	25	4	1.2	50	5°	121	Weldon

● : Line up

Reference pages: Standard cutting conditions → **I025**

TEC**H4X**CF-R

4 flute chatter dampening endmill, variable helix and variable pitch, extra long neck type

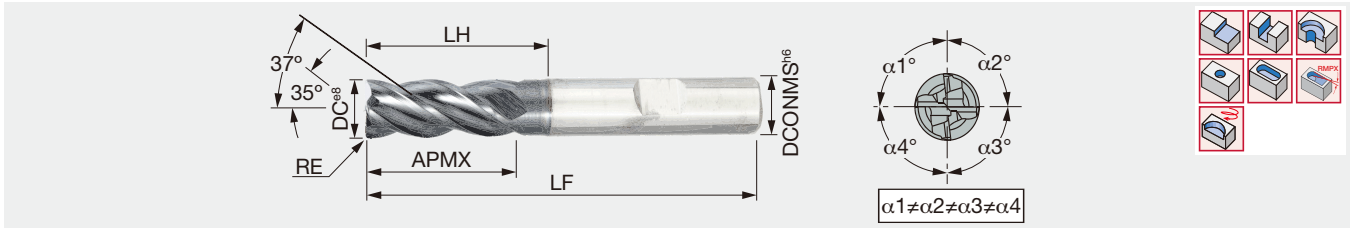

Designation	AH725	DC	DCONMS	NOF	RE	APMX	RMPX	LH	LF	Shank
TEC060H4X-12/25C06CF-R02	●	6	6	4	0.2	12	5°	25	61	Cylindrical
TEC060H4X-12/25W06CF-R02	●	6	6	4	0.2	12	5°	25	61	Weldon
TEC080H4X-16/32C08CF-R04	●	8	8	4	0.4	16	5°	32	68	Cylindrical
TEC080H4X-16/32W08CF-R04	●	8	8	4	0.4	16	5°	32	68	Weldon
TEC100H4X-20/40C10CF-R05	●	10	10	4	0.5	20	5°	40	80	Cylindrical
TEC100H4X-20/40W10CF-R05	●	10	10	4	0.5	20	5°	40	80	Weldon
TEC120H4X-24/50C12CF-R06	●	12	12	4	0.6	24	5°	50	95	Cylindrical
TEC120H4X-24/50W12CF-R06	●	12	12	4	0.6	24	5°	50	95	Weldon
TEC160H4X-32/64C16CF-R08	●	16	16	4	0.8	32	5°	64	115	Cylindrical
TEC160H4X-32/64W16CF-R08	●	16	16	4	0.8	32	5°	64	115	Weldon
TEC200H4X-40/75C20CF-R10	●	20	20	4	1	40	5°	75	125	Cylindrical
TEC200H4X-40/75W20CF-R10	●	20	20	4	1	40	5°	75	125	Weldon

● : Line up

Reference pages: Standard cutting conditions → I025

VARIABLE MEISTER

TECA**H3**CF-R

3 flute endmill, 39°-41° variable helix and variable pitch, center cutting edge, for aluminium machining

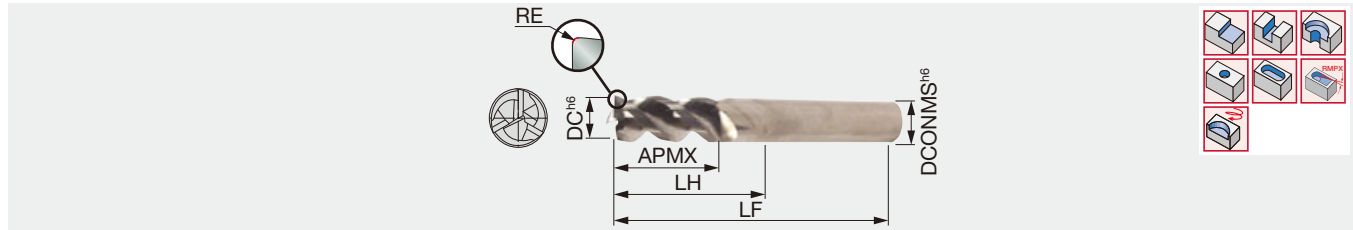

Designation	KS15F	DC	DCONMS	NOF	RE	APMX	LH	LF	Shank
TECA010H3-04C06CF-R.05	●	1	6	3	0.05	4	6	57	Cylindrical
TECA015H3-04/06C06CF-R01	●	1.5	6	3	0.1	4	6	57	Cylindrical
TECA020H3-05/08C06CF-R01	●	2	6	3	0.1	5	8	57	Cylindrical
TECA025H3-05/08C06CF-R01	●	2.5	6	3	0.1	5	8	57	Cylindrical
TECA030H3-07/12C06CF-R01	●	3	6	3	0.1	7	12	57	Cylindrical
TECA040H3-10/16C06CF-R02	●	4	6	3	0.2	10	16	57	Cylindrical
TECA050H3-12/20C06CF-R02	●	5	6	3	0.2	12	20	57	Cylindrical
TECA060H3-09/18C06CF-R02	●	6	6	3	0.2	9	18	57	Cylindrical
TECA060H3-09/18C06CF-R04	●	6	6	3	0.4	9	18	57	Cylindrical
TECA060H3-09/18C06CF-R08	●	6	6	3	0.8	9	18	57	Cylindrical
TECA060H3-09/30C06CF-R02	●	6	6	3	0.2	9	30	65	Cylindrical
TECA060H3-09/30C06CF-R04	●	6	6	3	0.4	9	30	65	Cylindrical
TECA060H3-09/30C06CF-R08	●	6	6	3	0.8	9	30	65	Cylindrical
TECA060H3-14/24C06CF-R02	●	6	6	3	0.2	14	24	60	Cylindrical
TECA080H3-12/24C08CF-R02	●	8	8	3	0.2	12	24	63	Cylindrical
TECA080H3-12/24C08CF-R04	●	8	8	3	0.4	12	24	63	Cylindrical
TECA080H3-12/24C08CF-R08	●	8	8	3	0.8	12	24	63	Cylindrical
TECA080H3-12/24C08CF-R30	●	8	8	3	3	12	24	63	Cylindrical
TECA080H3-12/40C08CF-R02	●	8	8	3	0.2	12	40	79	Cylindrical
TECA080H3-12/40C08CF-R04	●	8	8	3	0.4	12	40	79	Cylindrical
TECA080H3-12/40C08CF-R08	●	8	8	3	0.8	12	40	79	Cylindrical
TECA080H3-18/32C08CF-R02	●	8	8	3	0.2	18	32	68	Cylindrical
TECA100H3-15/30C10CF-R02	●	10	10	3	0.2	15	30	72	Cylindrical
TECA100H3-15/30C10CF-R04	●	10	10	3	0.4	15	30	72	Cylindrical
TECA100H3-15/30C10CF-R08	●	10	10	3	0.8	15	30	72	Cylindrical
TECA100H3-15/30C10CF-R16	●	10	10	3	1.6	15	30	72	Cylindrical
TECA100H3-15/30C10CF-R30	●	10	10	3	3	15	30	72	Cylindrical
TECA100H3-15/50C10CF-R02	●	10	10	3	0.2	15	50	92	Cylindrical
TECA100H3-15/50C10CF-R04	●	10	10	3	0.4	15	50	92	Cylindrical
TECA100H3-15/50C10CF-R08	●	10	10	3	0.8	15	50	92	Cylindrical
TECA100H3-15/50C10CF-R16	●	10	10	3	1.6	15	50	92	Cylindrical
TECA100H3-15/50C10CF-R20	●	10	10	3	2	15	50	92	Cylindrical
TECA100H3-15/50C10CF-R30	●	10	10	3	3	15	50	92	Cylindrical
TECA100H3-22/40C10CF-R02	●	10	10	3	0.2	22	40	80	Cylindrical
TECA100H3-22/40C10CF-R30	●	10	10	3	3	22	40	80	Cylindrical
TECA120H3-18/36C12CF-R02	●	12	12	3	0.2	18	36	83	Cylindrical
TECA120H3-18/36C12CF-R04	●	12	12	3	0.4	18	36	83	Cylindrical
TECA120H3-18/36C12CF-R08	●	12	12	3	0.8	18	36	83	Cylindrical
TECA120H3-18/36C12CF-R16	●	12	12	3	1.6	18	36	83	Cylindrical
TECA120H3-18/36C12CF-R20	●	12	12	3	2	18	36	83	Cylindrical
TECA120H3-18/36C12CF-R25	●	12	12	3	2.5	18	36	83	Cylindrical
TECA120H3-18/60C12CF-R02	●	12	12	3	0.2	18	60	100	Cylindrical
TECA120H3-18/60C12CF-R04	●	12	12	3	0.4	18	60	100	Cylindrical
TECA120H3-18/60C12CF-R08	●	12	12	3	0.8	18	60	100	Cylindrical
TECA120H3-18/60C12CF-R16	●	12	12	3	1.6	18	60	100	Cylindrical
TECA120H3-18/60C12CF-R20	●	12	12	3	2	18	60	100	Cylindrical
TECA120H3-18/60C12CF-R25	●	12	12	3	2.5	18	60	100	Cylindrical
TECA120H3-18/60C12CF-R30	●	12	12	3	3	18	60	100	Cylindrical
TECA160H3-24/48C16CF-R02	●	16	16	3	0.2	24	48	92	Cylindrical
TECA160H3-24/48C16CF-R04	●	16	16	3	0.4	24	48	92	Cylindrical
TECA160H3-24/48C16CF-R08	●	16	16	3	0.8	24	48	92	Cylindrical
TECA160H3-24/48C16CF-R16	●	16	16	3	1.6	24	48	92	Cylindrical
TECA160H3-24/48C16CF-R20	●	16	16	3	2	24	48	92	Cylindrical
TECA160H3-24/48C16CF-R25	●	16	16	3	2.5	24	48	92	Cylindrical

● : Line up

Reference pages: Standard cutting conditions → [I025](#)

Designation	KS15F	DC	DCONMS	NOF	RE	APMX	LH	LF	Shank
TECA160H3-24/48C16CF-R30	●	16	16	3	3	24	48	92	Cylindrical
TECA160H3-24/48C16CF-R32	●	16	16	3	3.2	24	48	92	Cylindrical
TECA160H3-24/48C16CF-R40	●	16	16	3	4	24	48	92	Cylindrical
TECA160H3-24/48C16CF-R50	●	16	16	3	5	24	48	92	Cylindrical
TECA160H3-24/80C16CF-R02	●	16	16	3	0.2	24	80	128	Cylindrical
TECA160H3-24/80C16CF-R04	●	16	16	3	0.4	24	80	128	Cylindrical
TECA160H3-24/80C16CF-R08	●	16	16	3	0.8	24	80	128	Cylindrical
TECA160H3-24/80C16CF-R16	●	16	16	3	1.6	24	80	128	Cylindrical
TECA160H3-24/80C16CF-R20	●	16	16	3	2	24	80	128	Cylindrical
TECA160H3-24/80C16CF-R25	●	16	16	3	2.5	24	80	128	Cylindrical
TECA160H3-24/80C16CF-R30	●	16	16	3	3	24	80	128	Cylindrical
TECA160H3-24/80C16CF-R32	●	16	16	3	3.2	24	80	128	Cylindrical
TECA160H3-24/80C16CF-R40	●	16	16	3	4	24	80	128	Cylindrical
TECA160H3-24/80C16CF-R50	●	16	16	3	5	24	80	128	Cylindrical
TECA160H3-34/64C16CF-R02	●	16	16	3	0.2	34	64	115	Cylindrical
TECA200H3-30/100C20CF-R02	●	20	20	3	0.2	30	100	150	Cylindrical
TECA200H3-30/100C20CF-R04	●	20	20	3	0.4	30	100	150	Cylindrical
TECA200H3-30/100C20CF-R08	●	20	20	3	0.8	30	100	150	Cylindrical
TECA200H3-30/100C20CF-R32	●	20	20	3	3.2	30	100	150	Cylindrical
TECA200H3-30/100C20CF-R40	●	20	20	3	4	30	100	150	Cylindrical
TECA200H3-30/100C20CF-R50	●	20	20	3	5	30	100	150	Cylindrical
TECA200H3-30/60C20CF-R02	●	20	20	3	0.2	30	60	110	Cylindrical
TECA200H3-30/60C20CF-R04	●	20	20	3	0.4	30	60	110	Cylindrical
TECA200H3-30/60C20CF-R08	●	20	20	3	0.8	30	60	110	Cylindrical
TECA200H3-30/60C20CF-R16	●	20	20	3	1.6	30	60	110	Cylindrical
TECA200H3-30/60C20CF-R20	●	20	20	3	2	30	60	110	Cylindrical
TECA200H3-30/60C20CF-R32	●	20	20	3	3.2	30	60	110	Cylindrical
TECA200H3-30/60C20CF-R40	●	20	20	3	4	30	60	110	Cylindrical
TECA200H3-30/60C20CF-R50	●	20	20	3	5	30	60	110	Cylindrical
TECA200H3-42/80C20CF-R02	●	20	20	3	0.2	42	80	130	Cylindrical
TECA250H3-38/125C25CF-R02	●	25	25	3	0.2	38	125	185	Cylindrical
TECA250H3-38/125C25CF-R08	●	25	25	3	0.8	38	125	185	Cylindrical
TECA250H3-38/125C25CF-R16	●	25	25	3	1.6	38	125	185	Cylindrical
TECA250H3-38/125C25CF-R20	●	25	25	3	2	38	125	185	Cylindrical
TECA250H3-38/125C25CF-R40	●	25	25	3	4	38	125	185	Cylindrical
TECA250H3-38/125C25CF-R50	●	25	25	3	5	38	125	185	Cylindrical
TECA250H3-38/75C25CF-R02	●	25	25	3	0.2	38	75	130	Cylindrical
TECA250H3-38/75C25CF-R04	●	25	25	3	0.4	38	75	130	Cylindrical
TECA250H3-38/75C25CF-R16	●	25	25	3	1.6	38	75	130	Cylindrical
TECA250H3-38/75C25CF-R20	●	25	25	3	2	38	75	130	Cylindrical
TECA250H3-38/75C25CF-R32	●	25	25	3	3.2	38	75	130	Cylindrical
TECA250H3-38/75C25CF-R50	●	25	25	3	5	38	75	130	Cylindrical
TECA250H3-52/100C25CF-R02	●	25	25	3	0.2	52	100	156	Cylindrical

● : Line up

Grade
Insert
Ext. Toolholder
Int. Toolholder
Threading
Grooving
Miniature tool
Milling cutter
Endmill
Drilling tool
Tooling System
User's Guide
Index



4 flute endmill, variable helix and variable pitch, relieved neck type, for aluminium machining (1.5xD, 2xD)

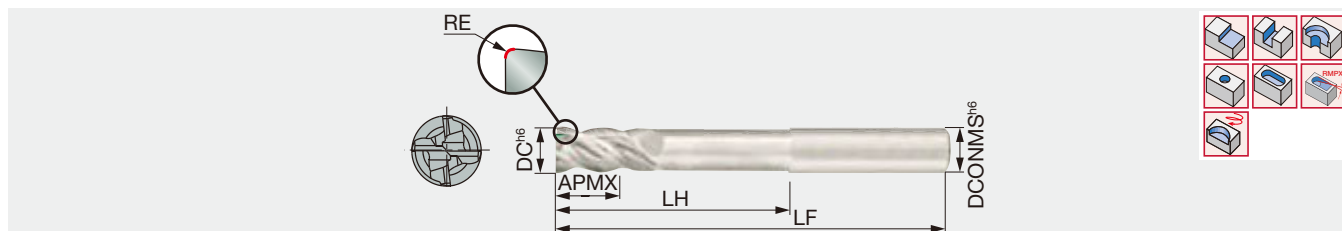

Designation	KS15F	DC	DCONMS	NOF	RE	APMX	LH	LF	Shank
TECA060H4-09/30C06CF-R02	●	6	6	4	0.2	9	30	65	Cylindrical
TECA060H4-12/18C06CF-R02	●	6	6	4	0.2	12	18	57	Cylindrical
TECA080H4-12/40C08CF-R02	●	8	8	4	0.2	12	40	79	Cylindrical
TECA080H4-16/24C08CF-R02	●	8	8	4	0.2	16	24	63	Cylindrical
TECA100H4-15/50C10CF-R02	●	10	10	4	0.2	15	50	92	Cylindrical
TECA100H4-20/30C10CF-R02	●	10	10	4	0.2	20	30	72	Cylindrical
TECA120H4-18/60C12CF-R02	●	12	12	4	0.2	18	60	100	Cylindrical
TECA120H4-24/36C12CF-R02	●	12	12	4	0.2	24	36	83	Cylindrical
TECA160H4-24/80C16CF-R02	●	16	16	4	0.2	24	80	128	Cylindrical
TECA160H4-32/48C16CF-R02	●	16	16	4	0.2	32	48	100	Cylindrical

● : Line up

TECAH3**CF-R**C**

3 flute endmill, variable helix and variable pitch, center cutting edge, for aluminium machining

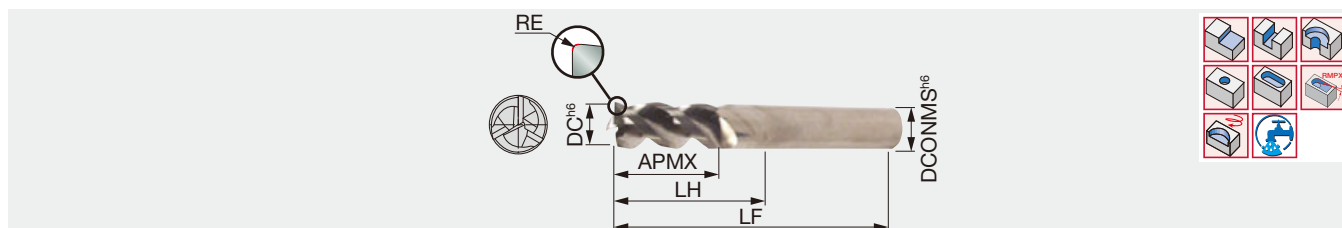

Designation	KS15F	DC	DCONMS	NOF	RE	APMX	LH	LF	Coolant hole	Shank
TECA060H3-12/18C06CF-R02C	●	6	6	3	0.2	12	18	57	With	Cylindrical
TECA060H3-12/30C06CF-R02C	●	6	6	3	0.2	12	30	65	With	Cylindrical
TECA080H3-16/24C08CF-R02C	●	8	8	3	0.2	16	24	63	With	Cylindrical
TECA080H3-16/40C08CF-R02C	●	8	8	3	0.2	16	40	79	With	Cylindrical
TECA100H3-20/30C10CF-R02C	●	10	10	3	0.2	20	30	72	With	Cylindrical
TECA100H3-20/50C10CF-R02C	●	10	10	3	0.2	20	50	100	With	Cylindrical
TECA120H3-24/36C12CF-R02C	●	12	12	3	0.2	24	36	83	With	Cylindrical
TECA120H3-24/60C12CF-R02C	●	12	12	3	0.2	24	60	100	With	Cylindrical
TECA160H3-32/48C16CF-R02C	●	16	16	3	0.2	32	48	92	With	Cylindrical
TECA160H3-32/80C16CF-R02C	●	16	16	3	0.2	32	80	128	With	Cylindrical
TECA250H3-50/75C25CF-R02C	●	25	25	3	0.2	50	75	130	With	Cylindrical

● : Line up

Reference pages: Standard cutting conditions → **I025**

STANDARD CUTTING CONDITIONS

Slotting / Roughing ($a_e = 0.4 \times D$ or over)

ISO	Workpiece material	Hardness	Vc (m/min)	fz (mm/t)			ap (Slotting)
				ø6 - ø8	ø10 - ø12	ø16 - ø20	
P	Carbon steel	- 300 HB	140 - 180	0.03 - 0.045	0.035 - 0.055	0.05 - 0.07	2xD
	Alloy steel	- 300 HB	70 - 150	0.025 - 0.04	0.035 - 0.055	0.05 - 0.07	2xD
M	Stainless steel	- 200 HB	60 - 100	0.025 - 0.045	0.035 - 0.05	0.04 - 0.065	1xD
K	Cast iron	150 - 200 HB	80 - 180	0.025 - 0.05	0.035 - 0.065	0.05 - 0.075	2xD
N	Aluminium alloy	-	300 - 750	0.025 - 0.05	0.035 - 0.065	0.035 - 0.09	2xD
S	Titanium alloy	- 40 HRC	20 - 50	0.025 - 0.04	0.03 - 0.05	0.035 - 0.085	1xD
H	Hardened steel	- 60 HRC	20 - 30	0.01 - 0.02	0.02 - 0.04	0.03 - 0.06	0.5xD

Semi-finishing / Shouldering ($a_e = 0.1 \sim 0.4 \times D$)

ISO	Workpiece material	Hardness	Vc (m/min)	fz (mm/t)			ap
				ø6 - ø8	ø10 - ø12	ø16 - ø20	
P	Carbon steel	- 300 HB	150 - 220	0.035 - 0.075	0.075 - 0.09	0.085 - 0.1	2xD
	Alloy steel	- 300 HB	70 - 160	0.025 - 0.065	0.05 - 0.09	0.055 - 0.09	2xD
M	Stainless steel	- 200 HB	80 - 130	0.03 - 0.05	0.04 - 0.06	0.05 - 0.065	2xD
K	Cast iron	150 - 250 HB	130 - 220	0.035 - 0.065	0.05 - 0.075	0.075 - 0.09	2xD
N	Aluminium alloy	-	350 - 850	0.05 - 0.075	0.075 - 0.1	0.1 - 0.125	2xD
S	Titanium alloy	- 40 HRC	40 - 60	0.035 - 0.05	0.04 - 0.065	0.06 - 0.1	2xD
H	Hardened steel	- 60 HRC	30 - 70	0.015 - 0.045	0.03 - 0.05	0.05 - 0.075	2xD

Finishing (feed rate depending on required accuracy) / High feed machining at low depth of cut ($a_e = 0.05 \sim 0.1 \times D$)

ISO	Workpiece material	Hardness	Vc (m/min)	fz (mm/t)			ap
				ø6 - ø8	ø10 - ø12	ø16 - ø20	
P	Carbon steel	- 300 HB	170 - 280	0.06 - 0.09	0.085 - 0.1	0.1 - 0.125	apmax
	Alloy steel	- 300 HB	110 - 220	0.06 - 0.09	0.085 - 0.1	0.1 - 0.125	apmax
M	Stainless steel	- 200 HB	100 - 160	0.035 - 0.055	0.05 - 0.065	0.055 - 0.075	apmax
K	Cast iron	150 - 250 HB	180 - 280	0.04 - 0.075	0.075 - 0.08	0.08 - 0.1	apmax
N	Aluminium alloy	-	350 - 900	0.055 - 0.09	0.085 - 0.125	0.125 - 0.18	apmax
S	Titanium alloy	- 40 HRC	50 - 70	0.04 - 0.065	0.05 - 0.075	0.075 - 0.11	apmax
H	Hardened steel	- 60 HRC	40 - 80	0.025 - 0.05	0.04 - 0.065	0.06 - 0.08	apmax

- When the depth of cut (a_e) is closer to the upper limit, please start with a lower limit value of cutting speed (Vc).
- Please set the cutting speed and the feed rate lower for the items with long slot according to how chattering occurs.
- While air blow is recommended, water-soluble coolant will be good for stainless steel, titanium alloy, and heat-resistant alloy.
- When chattering occurs with low rigid machines or settings, reduce cutting speed and feed at an equal rate.
- When chattering occurs with long tool overhang, reduce cutting speed and feed by 20 to 40%.



4 flute endmill, 38° helix angle, variable pitch, roughing and finishing combination type

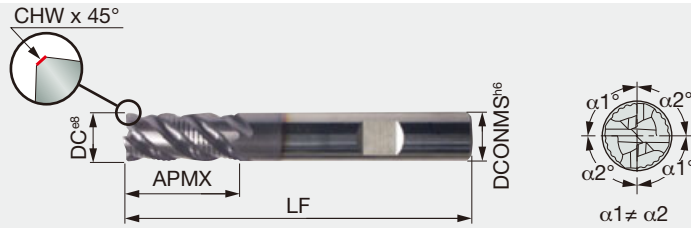

Designation	AH725	DC	DCONMS	NOF	CHW	APMX	LF	Shank
TEFS060E44-14C06CF57	●	6	6	4	0.25	14	57	Cylindrical
TEFS060E44-14W06CF-57	●	6	6	4	0.25	14	57	Weldon
TEFS080E44-18C08CF63	●	8	8	4	0.3	18	63	Cylindrical
TEFS080E44-18W08CF-63	●	8	8	4	0.3	18	63	Weldon
TEFS100E44-22C10CF72	●	10	10	4	0.4	22	72	Cylindrical
TEFS100E44-22W10CF-72	●	10	10	4	0.4	22	72	Weldon
TEFS120E44-26C12CF83	●	12	12	4	0.5	26	83	Cylindrical
TEFS120E44-26W12CF-83	●	12	12	4	0.5	26	83	Weldon
TEFS140E44-30C14CF83	●	14	14	4	0.5	30	83	Cylindrical
TEFS140E44-30W14CF-83	●	14	14	4	0.5	30	83	Weldon
TEFS160E44-34C16CF92	●	16	16	4	0.6	34	92	Cylindrical
TEFS160E44-34W16CF-92	●	16	16	4	0.6	34	92	Weldon
TEFS200E44-42C20CF104	●	20	20	4	0.6	42	104	Cylindrical
TEFS200E44-42W20CF-104	●	20	20	4	0.6	42	104	Weldon
TEFS250E44-52C25CF121	●	25	25	4	0.6	52	121	Cylindrical
TEFS250E44-52W25CF-121	●	25	25	4	0.6	52	121	Weldon

● : Line up

2

3

4

5

6
or more

P

M

K

N

S

H

Reference pages: Standard cutting conditions → **I033**

TEFS**B44

4 flute endmill, 45° helix angle, roughing and finishing combination type

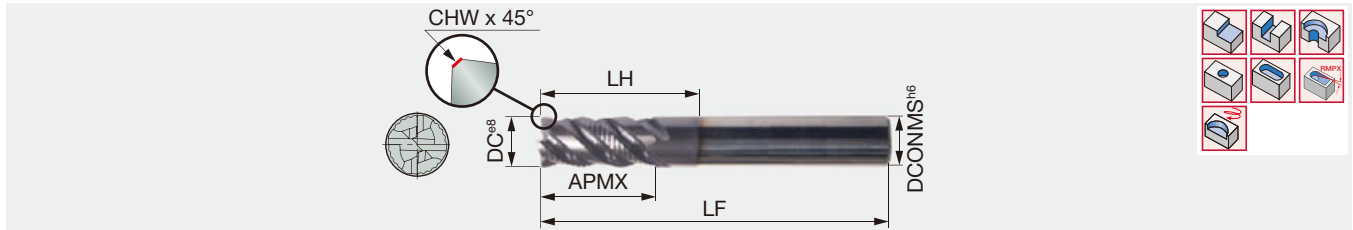

Designation	AH725	DC	DCONMS	NOF	CHW	APMX	LH	LF	Shank
TEFS040B44-10C06-57	●	4	6	4	0.12	10	-	57	Cylindrical
TEFS050B44-12C06-57	●	5	6	4	0.18	12	-	57	Cylindrical
TEFS060B44-14/20C06-57	●	6	6	4	0.25	14	20	57	Cylindrical
TEFS060B44-14/20W06-57	●	6	6	4	0.25	14	20	57	Weldon
TEFS060B44-14C06-57	●	6	6	4	0.25	14	-	57	Cylindrical
TEFS060B44-14W06-57	●	6	6	4	0.25	14	-	57	Weldon
TEFS080B44-18/26C08-63	●	8	8	4	0.3	18	26	63	Cylindrical
TEFS080B44-18/26W08-63	●	8	8	4	0.3	18	26	63	Weldon
TEFS080B44-18C08-63	●	8	8	4	0.3	18	-	63	Cylindrical
TEFS080B44-18W08-63	●	8	8	4	0.3	18	-	63	Weldon
TEFS100B44-22/32C10-72	●	10	10	4	0.3	22	32	72	Cylindrical
TEFS100B44-22/32W10-72	●	10	10	4	0.3	22	32	72	Weldon
TEFS100B44-22C10-72	●	10	10	4	0.3	22	-	72	Cylindrical
TEFS100B44-22W10-72	●	10	10	4	0.3	22	-	72	Weldon
TEFS120B44-26/38C12-83	●	12	12	4	0.4	26	38	83	Cylindrical
TEFS120B44-26/38W12-83	●	12	12	4	0.4	26	38	83	Weldon
TEFS120B44-26C12-83	●	12	12	4	0.4	26	-	83	Cylindrical
TEFS120B44-26W12-83	●	12	12	4	0.4	26	-	83	Weldon
TEFS140B44-30C14-83	●	14	14	4	0.4	30	-	83	Cylindrical
TEFS140B44-30W14-83	●	14	14	4	0.4	30	-	83	Weldon
TEFS160B44-34/50C16-100	●	16	16	4	0.6	34	50	100	Cylindrical
TEFS160B44-34/50W16-100	●	16	16	4	0.6	34	50	100	Weldon
TEFS160B44-34C16-92	●	16	16	4	0.6	34	-	92	Cylindrical
TEFS160B44-34W16-92	●	16	16	4	0.6	34	-	92	Weldon
TEFS200B44-42/62C20-125	●	20	20	4	0.6	42	62	125	Cylindrical
TEFS200B44-42/62W20-125	●	20	20	4	0.6	42	62	125	Weldon
TEFS200B44-42C20-104	●	20	20	4	0.6	42	-	104	Cylindrical
TEFS200B44-42W20-104	●	20	20	4	0.6	42	-	104	Weldon
TEFS250B44-52C25-121	●	25	25	4	0.6	52	-	121	Cylindrical
TEFS250B44-52W25-121	●	25	25	4	0.6	52	-	121	Weldon

● : Line up

SHREDMEISTER

TECR**B*S

4-7 flute roughing endmill, 45° helix angle, short type

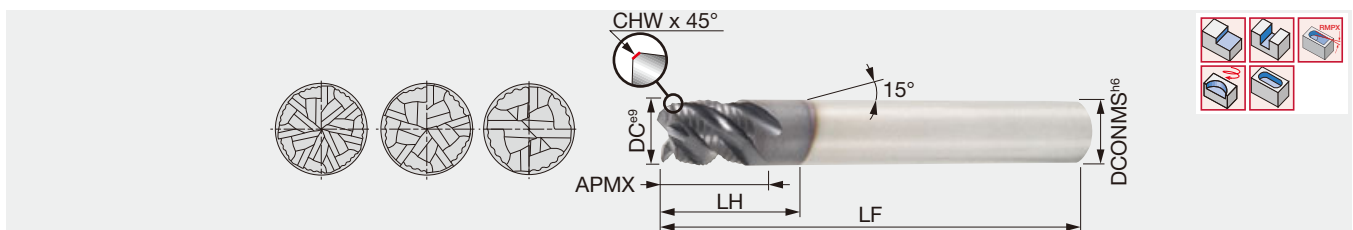

Designation	AH725	DC	DCONMS	NOF	CHW	APMX	LH	LF	Shank
TECR050B4S-05W06-57	●	5	6	4	0.2	5	10	57	Weldon
TECR060B4S-06W06-57	●	6	6	4	0.25	6	-	57	Weldon
TECR080B4S-08W08-63	●	8	8	4	0.25	8	-	63	Weldon
TECR100B4S-10W10-72	●	10	10	4	0.3	10	-	72	Weldon
TECR120B4S-12W12-83	●	12	12	4	0.35	12	-	83	Weldon
TECR160B5S-16W16-92	●	16	16	5	0.4	16	-	92	Weldon
TECR200B7S-20W20-104	●	20	20	7	0.4	20	-	104	Weldon

● : Line up

Reference pages: Standard cutting conditions → I033



4 - 7 flute roughing endmill, 45° helix angle

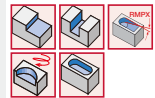
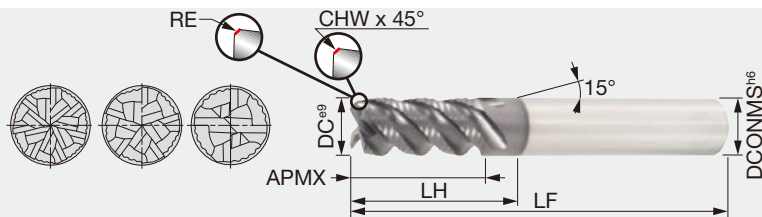

Designation	AH725	DC	DCONMS	NOF	CHW	RE	APMX	LH	LF		Shank
TECR050B4M-10C06-57	●	5	6	4	0.2	-	10	15	57	✓	Cylindrical
TECR050B4M-10W06-57	●	5	6	4	0.2	-	10	15	57	✓	Weldon
TECR060B4M-12C06-57	●	6	6	4	0.25	-	12	-	57	✓	Cylindrical
TECR060B4M-12W06-57	●	6	6	4	0.25	-	12	-	57	✓	Weldon
TECR080B4M-16C08-63	●	8	8	4	0.25	-	16	-	63	✓	Cylindrical
TECR080B4M-16W08-63	●	8	8	4	0.25	-	16	-	63	✓	Weldon
TECR100B4M-20C10-72	●	10	10	4	0.3	-	20	-	72	✓	Cylindrical
TECR100B4M-20C10-72R10	●	10	10	4	-	1	20	-	72	✓	Cylindrical
TECR100B4M-20W10-72	●	10	10	4	0.3	-	20	-	72	✓	Weldon
TECR120B4M-24C12-83	●	12	12	4	0.35	-	24	-	83	✓	Cylindrical
TECR120B4M-24C12-83R12	●	12	12	4	-	1.2	24	-	83	✓	Cylindrical
TECR120B4M-24W12-83	●	12	12	4	0.35	-	24	-	83	✓	Weldon
TECR120B4M-24W12-83R12	●	12	12	4	-	1.2	24	-	83	✓	Weldon
TECR160B5M-32C16-92	●	16	16	5	0.4	-	32	-	92		Cylindrical
TECR160B5M-32C16-92R16	●	16	16	5	-	1.6	32	-	92		Cylindrical
TECR160B5M-32W16-92	●	16	16	5	0.4	-	32	-	92		Weldon
TECR160B5M-32W16-92R16	●	16	16	5	-	1.6	32	-	92		Weldon
TECR200B7M-40C20-104	●	20	20	7	0.4	-	40	-	104		Cylindrical
TECR200B7M-40W20-104	●	20	20	7	0.4	-	40	-	104		Weldon

● : Line up

2

TECR**B*MF

4 - 6 flute roughing endmill, 45° helix angle

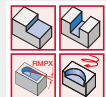
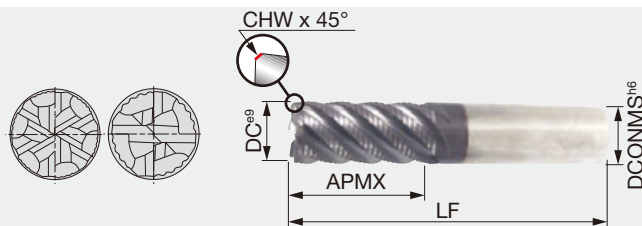

Designation	AH725	DC	DCONMS	NOF	CHW	APMX	LF	Shank
TECR060B4MF-14W06-57	●	6	6	4	0.25	14	57	Weldon
TECR080B4MF-18W08-63	●	8	8	4	0.3	18	63	Weldon
TECR100B4MF-22W10-72	●	10	10	4	0.3	22	72	Weldon
TECR120B4MF-26W12-83	●	12	12	4	0.4	26	83	Weldon
TECR140B4MF-30W14-83	●	14	14	4	0.4	30	83	Weldon
TECR160B6MF-34W16-92	●	16	16	6	0.5	34	92	Weldon
TECR200B6MF-42W20-104	●	20	20	6	0.7	42	104	Weldon
TECR250B6MF-52W25-121	●	25	25	6	0.9	52	121	Weldon

● : Line up

Reference pages: Standard cutting conditions → I033

TECR**B*L

4 - 7 flute roughing endmill, 45° helix angle, long neck type (3xD)

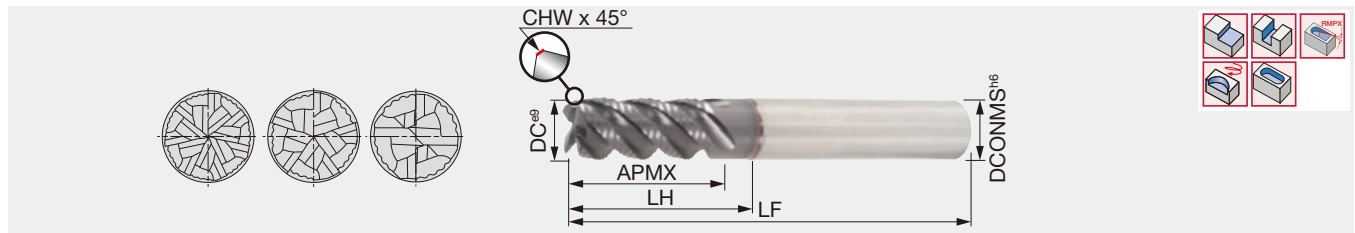



Designation	AH725	DC	DCONMS	NOF	CHW	APMX	LH	LF		Shank
TECR060B4L-12/18W06-57	●	6	6	4	0.25	12	18	57	✓	Weldon
TECR080B4L-16/24W08-63	●	8	8	4	0.25	16	24	63	✓	Weldon
TECR100B4L-20/30W10-72	●	10	10	4	0.3	20	30	72	✓	Weldon
TECR120B4L-24/36W12-83	●	12	12	4	0.35	24	36	83	✓	Weldon
TECR160B5L-32/48W16-100	●	16	16	5	0.4	32	48	100		Weldon
TECR200B7L-40/60W20-110	●	20	20	7	0.4	40	60	110		Weldon

● : Line up

TECR**B*X

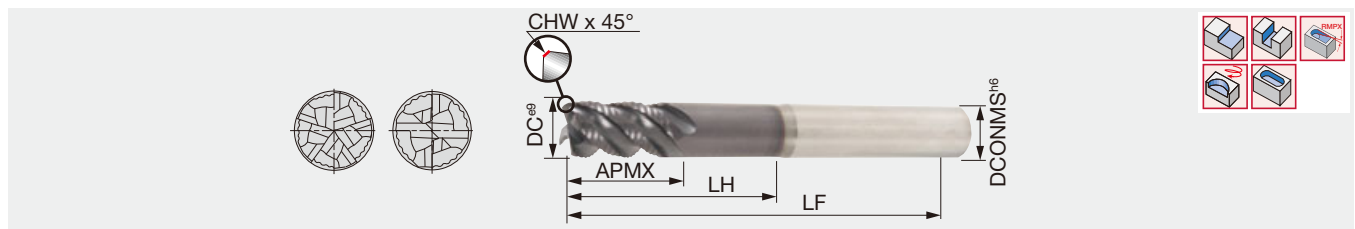
4 - 5 flute roughing endmill, 45° helix angle, long neck type (4xD)



Designation	AH725	DC	DCONMS	NOF	CHW	APMX	LH	LF		Shank
TECR080B4X-12/32W08-68	●	8	8	4	0.25	12	32	68	✓	Weldon
TECR100B4X-15/40W10-80	●	10	10	4	0.3	15	40	80	✓	Weldon
TECR120B4X-18/48W12-100	●	12	12	4	0.35	18	48	100	✓	Weldon
TECR160B5X-24/64W16-115	●	16	16	5	0.4	24	64	115		Weldon

● : Line up

TERF**A/E

3 - 4 flute roughing endmill, 30° or 38 helix angle, for alloy steel and stainless steel

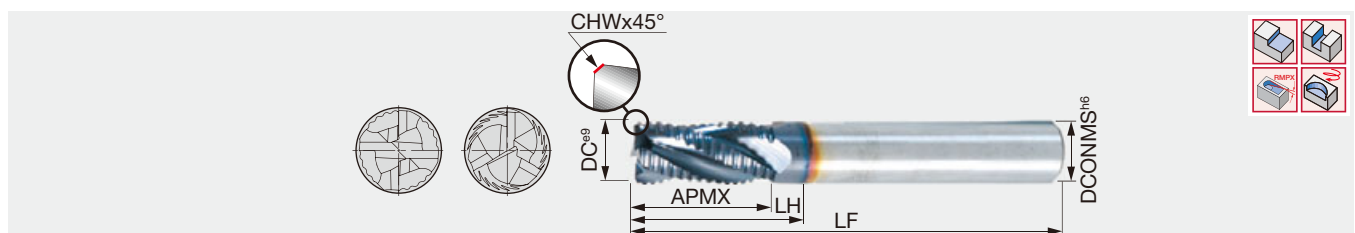

Designation	AH725	DC	DCONMS	NOF	CHW	APMX	LH	LF	FHA	Shank
TERF040E3-08C06-57	●	4	6	3	0.25	8	13	57	38°	Cylindrical
TERF050E3-10C06-57	●	5	6	3	0.3	10	17	57	38°	Cylindrical
TERF060E3-13C06-57	●	6	6	3	0.3	13	21	57	38°	Cylindrical
TERF070E3-20C08-63	●	7	8	3	0.3	20	26	63	38°	Cylindrical
TERF080E3-20C08-63	●	8	8	3	0.3	20	28	63	38°	Cylindrical
TERF090A4-22C10-72	●	9	10	4	0.3	22	30	72	30°	Cylindrical
TERF100A4-22C10-72	●	10	10	4	0.3	22	30	72	30°	Cylindrical
TERF110A4-25C12-83	●	11	12	4	0.3	25	32	83	30°	Cylindrical
TERF120A4-25C12-83	●	12	12	4	0.4	25	37	83	30°	Cylindrical
TERF140A4-25C14-83	●	14	14	4	0.5	25	37	83	30°	Cylindrical
TERF160A4-32C16-92	●	16	16	4	0.5	32	44	92	30°	Cylindrical
TERF180A4-32C18-92	●	18	18	4	0.5	32	44	92	30°	Cylindrical
TERF200A4-38C20-104	●	20	20	4	0.6	38	55	104	30°	Cylindrical

● : Line up

Reference pages: Standard cutting conditions → I033

4 flute roughing endmill, 20° helix angle

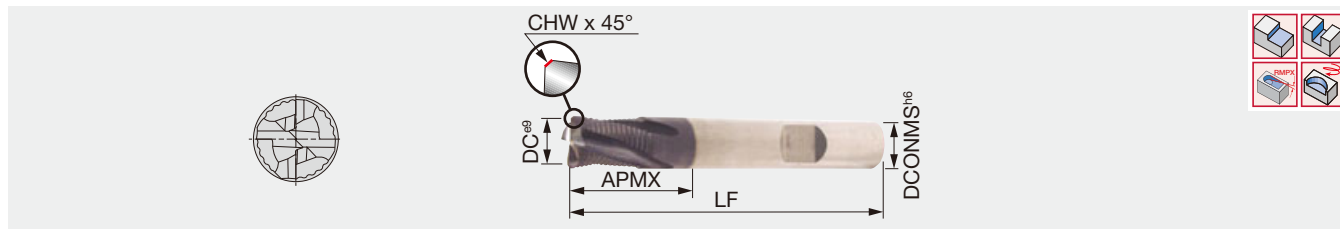

Designation	AH725	DC	DCONMS	NOF	CHW	APMX	LF	Shank
TECR060T4M-10W06-57	●	6	6	4	0.3	10	57	Weldon
TECR080T4M-16W08-63	●	8	8	4	0.4	16	63	Weldon
TECR100T4M-20W10-72	●	10	10	4	0.4	20	72	Weldon
TECR120T4M-24W12-83	●	12	12	4	0.4	24	83	Weldon
TECR160T4M-32W16-92	●	16	16	4	0.5	32	92	Weldon
TECR200T4M-40W20-104	●	20	20	4	0.5	40	104	Weldon

● : Line up

TECPE*L**

3 flute roughing endmill, 38° helix angle

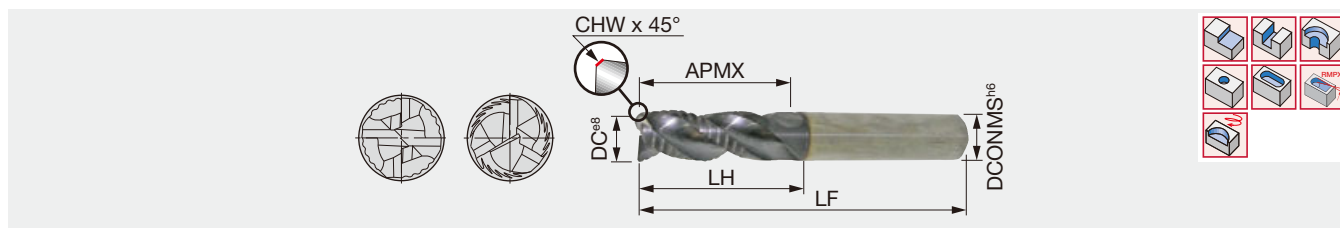

Designation	AH725	DC	DCONMS	NOF	CHW	APMX	LH	LF	Shank
TECP050E3L-12/17W06S57	●	5	6	3	0.3	12	17	57	Weldon
TECP060E3L-14/20W06S57	●	6	6	3	0.4	14	20	57	Weldon
TECP080E3L-18/26W08S63	●	8	8	3	0.4	18	26	63	Weldon
TECP100E3L-22/32W10S72	●	10	10	3	0.4	22	32	72	Weldon
TECP120E3L-26/38W12S83	●	12	12	3	0.4	26	38	83	Weldon
TECP140E3L-30/44W14S100	●	14	14	3	0.6	30	44	100	Weldon
TECP160E3L-34/50W16S100	●	16	16	3	0.5	34	50	100	Weldon
TECP200E3L-42/62W20S125	●	20	20	3	0.5	42	62	125	Weldon

4 flute roughing endmill, 38° helix angle

Designation	AH725	DC	DCONMS	NOF	CHW	APMX	LH	LF	Shank
TECP050E4L-12/17W06S57	●	5	6	4	0.3	12	17	57	Weldon
TECP060E4L-14/20W06S57	●	6	6	4	0.4	14	20	57	Weldon
TECP080E4L-18/26W08S63	●	8	8	4	0.4	18	26	63	Weldon
TECP100E4L-22/32W10S72	●	10	10	4	0.4	22	32	72	Weldon
TECP120E4L-26/38W12S83	●	12	12	4	0.4	26	38	83	Weldon
TECP140E4L-30/44W14S100	●	14	14	4	0.6	30	44	100	Weldon
TECP160E4L-34/50W16S100	●	16	16	4	0.5	34	50	100	Weldon
TECP200E4L-42/62W20S125	●	20	20	4	0.5	42	62	125	Weldon

● : Line up

Reference pages: Standard cutting conditions → **I033**

TEAP**H3**CFR**C

3 flute endmill, variable helix and variable pitch with chip splitter, relieved neck type, for aluminium machining

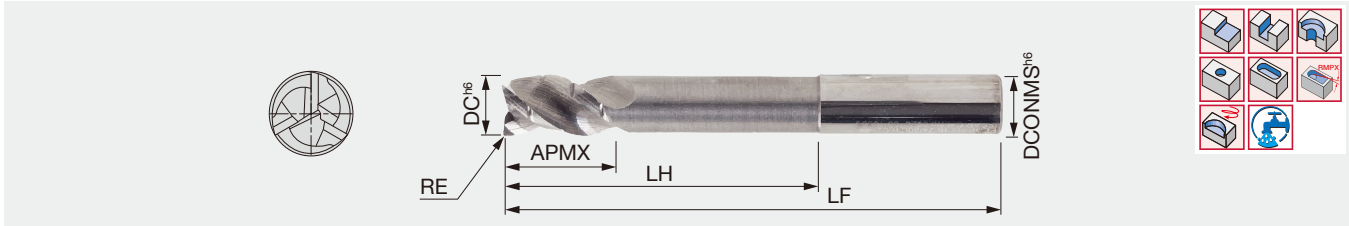

Designation	KS15F	DC	DCONMS	NOF	RE	APMX	LH	LF	Coolant hole	Shank
TEAP100H3-15/50C10CFR02C	●	10	10	3	0.2	15	50	92	With	Cylindrical
TEAP100H3-22/40C10CFR02C	●	10	10	3	0.2	22	40	80	With	Cylindrical
TEAP120H3-18/60C12CFR02C	●	12	12	3	0.2	18	60	100	With	Cylindrical
TEAP120H3-26/48C12CFR02C	●	12	12	3	0.2	26	48	93	With	Cylindrical
TEAP160H3-24/80C16CFR02C	●	16	16	3	0.2	24	80	128	With	Cylindrical
TEAP160H3-34/64C16CFR02C	●	16	16	3	0.2	34	64	115	With	Cylindrical
TEAP200H3-42/80C20CFR02C	●	20	20	3	0.2	42	80	130	With	Cylindrical
TEAP200H3-30/100C20CFR02C	●	20	20	3	0.2	30	100	150	With	Cylindrical

● : Line up

TERC**E3

3 flute roughing endmill, 38° helix angle, for aluminium alloy and non-ferrous metal

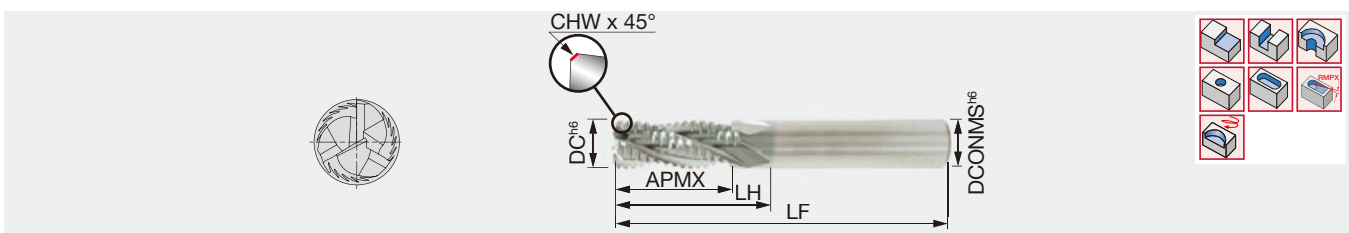

Designation	KS15F	DC	DCONMS	NOF	CHW	APMX	LH	LF	Shank
TERC060E3-13C06-57	●	6	6	3	0.5	13	21	57	Cylindrical
TERC080E3-20C08-63	●	8	8	3	0.5	20	28	63	Cylindrical
TERC100E3-22C10-72	●	10	10	3	0.6	22	30	72	Cylindrical
TERC120E3-25C12-83	●	12	12	3	0.6	25	37	83	Cylindrical
TERC140E3-25C14-83	●	14	14	3	0.6	25	37	83	Cylindrical
TERC160E3-32C16-92	●	16	16	3	0.6	32	44	92	Cylindrical
TERC200E3-38C20-104	●	20	20	3	0.7	38	55	104	Cylindrical
TERC250E3-45C25-121	●	25	25	3	0.7	45	64	121	Cylindrical

● : Line up

3 flute roughing endmill, 45° helix angle, relieved neck type, for aluminium machining

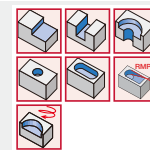
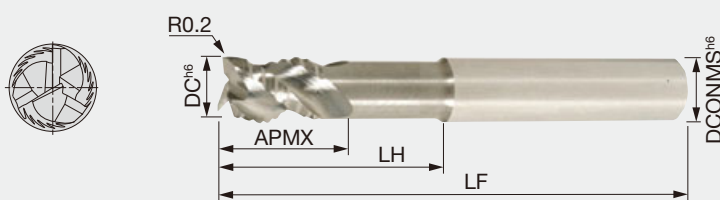

Designation	KS15F	DC	DCONMS	NOF	APMX	LH	LF	Shank
TECR060B3-09/21C06R02A57	●	6	6	3	9	21	57	Cylindrical
TECR060B3-09/21W06R02A57	●	6	6	3	9	21	57	Weldon
TECR060B3-09/30C06R02A65	●	6	6	3	9	30	65	Cylindrical
TECR060B3-09/30W06R02A65	●	6	6	3	9	30	65	Weldon
TECR080B3-12/27C08R02A63	●	8	8	3	12	27	63	Cylindrical
TECR080B3-12/27W08R02A63	●	8	8	3	12	27	63	Weldon
TECR080B3-12/40C08R02A78	●	8	8	3	12	40	78	Cylindrical
TECR080B3-12/40W08R02A78	●	8	8	3	12	40	78	Weldon
TECR100B3-12/31C10R02A72	●	10	10	3	12	31	72	Cylindrical
TECR100B3-12/31W10R02A72	●	10	10	3	12	31	72	Weldon
TECR100B3-12/50C10R02A100	●	10	10	3	12	50	100	Cylindrical
TECR100B3-12/50W10R02A100	●	10	10	3	12	50	100	Weldon
TECR120B3-12/37C12R02A83	●	12	12	3	12	37	83	Cylindrical
TECR120B3-12/37W12R02A83	●	12	12	3	12	37	83	Weldon
TECR120B3-14/55C12R02A100	●	12	12	3	14	55	100	Cylindrical
TECR120B3-14/55W12R02A100	●	12	12	3	14	55	100	Weldon
TECR160B3-14/43C16R02A92	●	16	16	3	14	43	92	Cylindrical
TECR160B3-14/43W16R02A92	●	16	16	3	14	43	92	Weldon
TECR160B3-18/80C16R02A150	●	16	16	3	18	80	150	Cylindrical
TECR160B3-18/80W16R02A150	●	16	16	3	18	80	150	Weldon
TECR200B3-17/53C20R02A104	●	20	20	3	17	53	104	Cylindrical
TECR200B3-17/53W20R02A104	●	20	20	3	17	53	104	Weldon
TECR200B3-22/80C20R02A150	●	20	20	3	22	80	150	Cylindrical
TECR200B3-22/80W20R02A150	●	20	20	3	22	80	150	Weldon

● : Line up

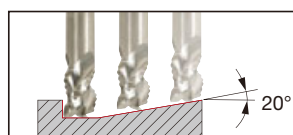

Rampdown angle

2

3

4

5

6

P

M

K

N

S

H

Reference pages: Standard cutting conditions → **I033**

STANDARD CUTTING CONDITIONS

Slotting / Roughing ($a_e = 0.4 \times D$ or over)

ISO	Workpiece material	Hardness	Vc (m/min)	fz (mm/t)			ap (Slotting)
				ø6 - ø8	ø10 - ø12	ø16 - ø20	
P	Carbon steel	- 300 HB	140 - 180	0.035 - 0.055	0.045 - 0.07	0.06 - 0.0825	2xD
	Alloy steel	- 300 HB	70 - 150	0.03 - 0.045	0.045 - 0.07	0.06 - 0.0825	2xD
M	Stainless steel	- 200 HB	60 - 100	0.03 - 0.055	0.045 - 0.06	0.05 - 0.0675	1xD
K	Cast iron	150 - 200 HB	80 - 180	0.03 - 0.06	0.045 - 0.08	0.06 - 0.09	2xD
N	Aluminium alloy	-	300 - 750	0.03 - 0.06	0.045 - 0.08	0.04 - 0.105	2xD
S	Titanium alloy	- 40 HRC	20 - 50	0.03 - 0.045	0.04 - 0.06	0.04 - 0.105	1xD
H	Hardened steel	- 60 HRC	20 - 30	0.015 - 0.025	0.025 - 0.07	0.06 - 0.075	0.5xD

Semi-finishing / Shouldering ($a_e = 0.1 \sim 0.4 \times D$)

ISO	Workpiece material	Hardness	Vc (m/min)	fz (mm/t)			ap
				ø6 - ø8	ø10 - ø12	ø16 - ø20	
P	Carbon steel	- 300 HB	150 - 220	0.045 - 0.09	0.09 - 0.11	0.1 - 0.12	2xD
	Alloy steel	- 300 HB	70 - 160	0.03 - 0.075	0.06 - 0.1	0.065 - 0.105	2xD
M	Stainless steel	- 200 HB	80 - 130	0.035 - 0.06	0.055 - 0.07	0.06 - 0.075	2xD
K	Cast iron	150 - 250 HB	130 - 220	0.045 - 0.075	0.06 - 0.09	0.09 - 0.105	2xD
N	Aluminium alloy	-	350 - 850	0.06 - 0.09	0.09 - 0.12	0.12 - 0.15	2xD
S	Titanium alloy	- 40 HRC	40 - 60	0.045 - 0.06	0.055 - 0.07	0.075 - 0.12	2xD
H	Hardened steel	- 60 HRC	30 - 70	0.02 - 0.055	0.045 - 0.07	0.06 - 0.09	2xD

Finishing (feed rate depending on required accuracy) / High feed machining at small width of cut ($a_e = 0.05 \sim 0.1 \times D$)

ISO	Workpiece material	Hardness	Vc (m/min)	fz (mm/t)			ap
				ø6 - ø8	ø10 - ø12	ø16 - ø20	
P	Carbon steel	- 300 HB	170 - 280	0.075 - 0.11	0.11 - 0.12	0.12 - 0.15	apmax
	Alloy steel	- 300 HB	110 - 220	0.075 - 0.11	0.11 - 0.12	0.12 - 0.15	apmax
M	Stainless steel	- 200 HB	100 - 160	0.045 - 0.07	0.06 - 0.075	0.065 - 0.09	apmax
K	Cast iron	150 - 250 HB	180 - 280	0.05 - 0.09	0.09 - 0.1	0.09 - 0.12	apmax
N	Aluminium alloy	-	350 - 900	0.065 - 0.11	0.11 - 0.15	0.15 - 0.22	apmax
S	Titanium alloy	- 40 HRC	50 - 70	0.055 - 0.075	0.06 - 0.09	0.09 - 0.12	apmax
H	Hardened steel	- 60 HRC	40 - 80	0.03 - 0.06	0.05 - 0.09	0.075 - 0.105	apmax

- When the depth of cut (a_e) is closer to the upper limit, please start with a lower limit value of cutting speed (Vc).
- While air blow is recommended, water-soluble coolant will be good for stainless steel, titanium alloy, and heat-resistant alloy.
- When chattering occurs with low rigid machines or settings, reduce cutting speed and feed at an equal rate.
- When chattering occurs with long tool overhang, reduce cutting speed and feed by 20 to 40%.

Grade
Insert
Ext. Toolholder
Int. Toolholder
Threading
Grooving
Miniature tool
Milling cutter
Endmill
Drilling tool
Tooling System
User's Guide
Index



4 - 6 flute endmill, 45° helix angle, long neck type

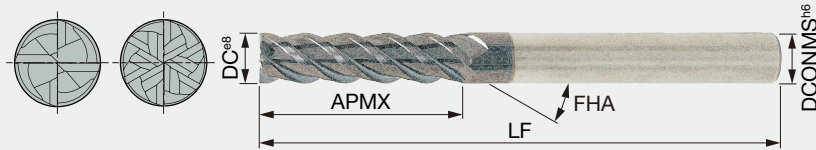



Designation	AH725	DC	DCONMS	NOF	APMX	FHA	LF		Shank
TEC060B4L-24C06-65	●	6	6	4	24	45°	65	✓	Cylindrical
TEC060B4L-24W06-65	●	6	6	4	24	45°	65	✓	Weldon
TEC080B4L-32C08-79	●	8	8	4	32	45°	79	✓	Cylindrical
TEC080B4L-32W08-79	●	8	8	4	32	45°	79	✓	Weldon
TEC100B4L-40C10-100	●	10	10	4	40	45°	100	✓	Cylindrical
TEC100B4L-40W10-100	●	10	10	4	40	45°	100	✓	Weldon
TEC120B4L-48C12-100	●	12	12	4	48	45°	100	✓	Cylindrical
TEC120B4L-48W12-100	●	12	12	4	48	45°	100	✓	Weldon
TEC140B4L-50C14-100	●	14	14	4	50	45°	100	✓	Cylindrical
TEC140B4L-50W14-100	●	14	14	4	50	45°	100	✓	Weldon
TEC160B6L-56C16-115	●	16	16	6	56	45°	115		Cylindrical
TEC160B6L-56W16-115	●	16	16	6	56	45°	115		Weldon
TEC200B6L-60C20-125	●	20	20	6	60	45°	125		Cylindrical
TEC200B6L-60W20-125	●	20	20	6	60	45°	125		Weldon

● : Line up

TECB4/6X**

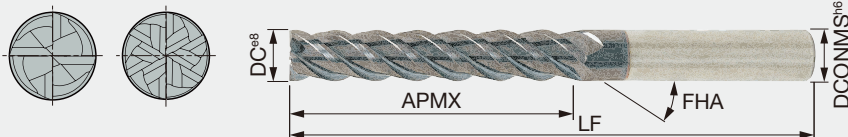
4 - 6 flute endmill, 45° helix angle, extra long neck type



Designation	AH725	DC	DCONMS	NOF	APMX	FHA	LF		Shank
TEC100B4X-60C10-112	●	10	10	4	60	45°	112	✓	Cylindrical
TEC100B4X-60W10-112	●	10	10	4	60	45°	112	✓	Weldon
TEC120B4X-72C12-150	●	12	12	4	72	45°	150	✓	Cylindrical
TEC120B4X-72W12-150	●	12	12	4	72	45°	150	✓	Weldon
TEC160B6X-80C16-150	●	16	16	6	80	45°	150		Cylindrical
TEC160B6X-80W16-150	●	16	16	6	80	45°	150		Weldon
TEC200B6X-80C20-150	●	20	20	6	80	45°	150		Cylindrical

● : Line up

Reference pages: Standard cutting conditions → **I047**

TECC**A/B2

2 flute slotting endmill, 30° or 45° helix angle

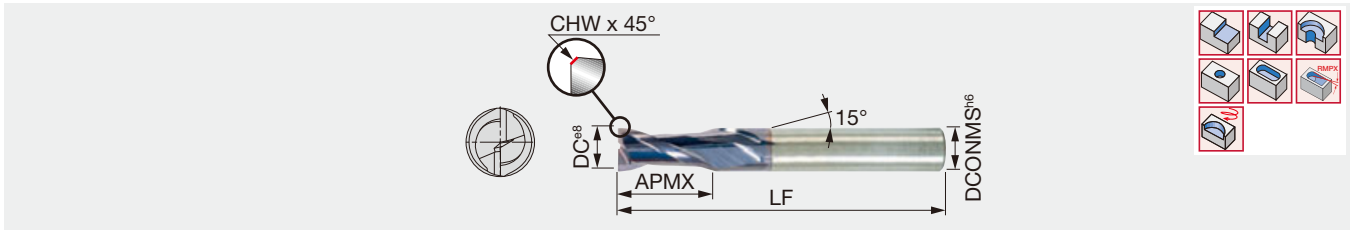

Designation	AH725	DC	DCONMS	NOF	CHW	APMX	LF	FHA	Shank
TECC020B2-07C03-38	●	2	3	2	0.1	7	38	45°	Cylindrical
TECC030A2-10C03-38	●	3	3	2	0.1	10	38	30°	Cylindrical
TECC040A2-12C04-50	●	4	4	2	0.1	12	50	30°	Cylindrical
TECC050A2-14C05-50	●	5	5	2	0.15	14	50	30°	Cylindrical
TECC060A2-16C06-57	●	6	6	2	0.15	16	57	30°	Cylindrical
TECC080A2-20C08-63	●	8	8	2	0.15	20	63	30°	Cylindrical
TECC100A2-22C10-72	●	10	10	2	0.15	22	72	30°	Cylindrical
TECC120A2-25C12-83	●	12	12	2	0.25	25	83	30°	Cylindrical
TECC160A2-32C16-92	●	16	16	2	0.25	32	92	30°	Cylindrical
TECC200A2-38C20-104	●	20	20	2	0.25	38	104	30°	Cylindrical

● : Line up

TECS/TECCS**E3

3 flute slotting endmill, 38° helix angle, short type

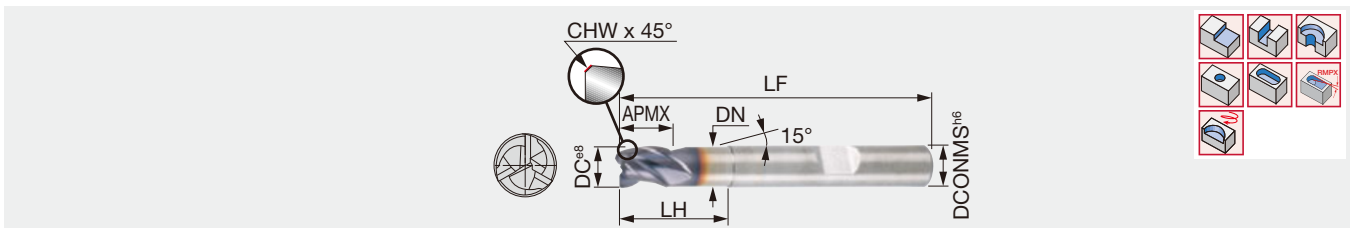

Designation	AH725	DC	DCONMS	NOF	CHW	DN	APMX	LH	LF	Shank
TECS020E3-03W06-57	●	2	6	3	0.1	1.9	3	7	57	Weldon
TECS030E3-04W06-57	●	3	6	3	0.1	2.9	4	10	57	Weldon
TECS040E3-05W06-57	●	4	6	3	0.1	3.9	5	12	57	Weldon
TECS050E3-06W06-57	●	5	6	3	0.15	4.9	6	14	57	Weldon
TECCS060E3-07W06-57	●	6	6	3	0.15	5.9	7	16	57	Weldon
TECCS080E3-09W08-63	●	8	8	3	0.15	7.6	9	20	63	Weldon
TECCS100E3-11W10-72	●	10	10	3	0.15	9.5	11	22	72	Weldon
TECCS120E3-12W12-83	●	12	12	3	0.25	11.3	12	25	83	Weldon
TECCS160E3-16W16-92	●	16	16	3	0.25	15.2	16	32	92	Weldon

● : Line up

Reference pages: Standard cutting conditions → **I047**

3 flute slotting endmill, 38° helix angle

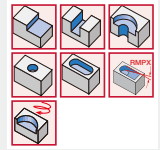
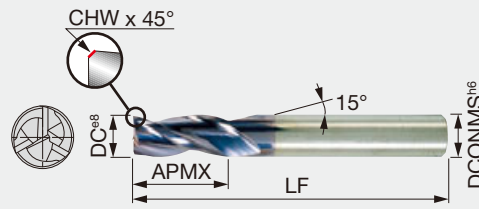

Designation	AH725	DC	DCONMS	NOF	CHW	APMX	LF	FHA	Shank
TECC040E3-12C04-50	●	4	4	3	0.1	12	50	38°	Cylindrical
TECC050E3-14C05-50	●	5	5	3	0.15	14	50	38°	Cylindrical
TECC060E3-16C06-57	●	6	6	3	0.15	16	57	38°	Cylindrical
TECC080E3-20C08-63	●	8	8	3	0.15	20	63	38°	Cylindrical
TECC100E3-22C10-72	●	10	10	3	0.15	22	72	38°	Cylindrical
TECC120E3-25C12-83	●	12	12	3	0.25	25	83	38°	Cylindrical
TECC160E3-32C16-92	●	16	16	3	0.25	32	92	38°	Cylindrical
TECC200E3-38C20-104	●	20	20	3	0.25	38	104	38°	Cylindrical

● : Line up

TEC**B3

3 flute slotting endmill, 45° helix angle

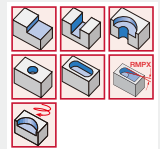
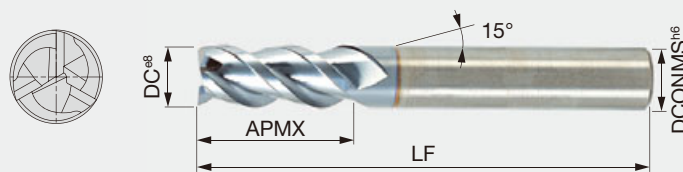

Designation	AH725	DC	NOF	DCONMS	APMX	LF	Shank
TEC060B3-16C06-57	●	6	3	6	16	57	Cylindrical
TEC080B3-20C08-63	●	8	3	8	20	63	Cylindrical
TEC090B3-20C09-67	●	9	3	9	20	67	Cylindrical
TEC100B3-22C10-72	●	10	3	10	22	72	Cylindrical
TEC120B3-25C12-83	●	12	3	12	25	83	Cylindrical
TEC180B3-32C18-92	●	18	3	18	32	92	Cylindrical

● : Line up

TECC**A/B4

4 flute endmill, 30° or 45° helix angle

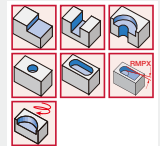
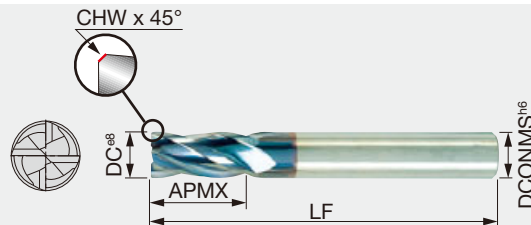

Designation	AH725	DC	DCONMS	NOF	CHW	APMX	LF	FHA	Shank
TECC020B4-07C03-38	●	2	3	4	0.1	7	38	45°	Cylindrical
TECC030A4-10C03-38	●	3	3	4	0.1	10	38	30°	Cylindrical
TECC040A4-12C04-50	●	4	4	4	0.1	12	50	30°	Cylindrical
TECC050A4-14C05-50	●	5	5	4	0.15	14	50	30°	Cylindrical
TECC060A4-16C06-57	●	6	6	4	0.15	16	57	30°	Cylindrical
TECC080A4-20C08-63	●	8	8	4	0.15	20	63	30°	Cylindrical
TECC100A4-22C10-72	●	10	10	4	0.15	22	72	30°	Cylindrical
TECC120A4-25C12-83	●	12	12	4	0.25	25	83	30°	Cylindrical
TECC160A4-32C16-92	●	16	16	4	0.25	32	92	30°	Cylindrical
TECC200A4-38C20-104	●	20	20	4	0.25	38	104	30°	Cylindrical

● : Line up

Reference pages: Standard cutting conditions → I047

TEC**B4

4 flute endmill, 45° helix angle

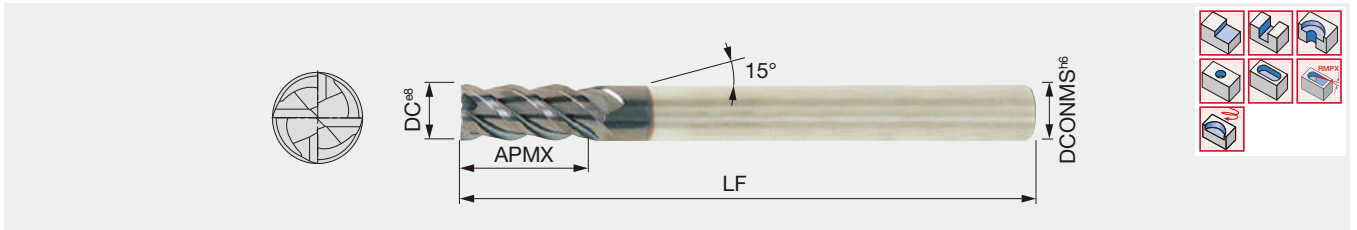

Designation	AH725	DC	DCONMS	NOF	APMX	LF	Shank
TEC020B4-07C06-57	●	2	6	4	7	57	Cylindrical
TEC030B4-10C06-57	●	3	6	4	10	57	Cylindrical
TEC040B4-12C06-57	●	4	6	4	12	57	Cylindrical
TEC050B4-14C06-57	●	5	6	4	14	57	Cylindrical
TEC060B4-16C06-57	●	6	6	4	16	57	Cylindrical
TEC080B4-20C08-63	●	8	8	4	20	63	Cylindrical
TEC100B4-22C10-72	●	10	10	4	22	72	Cylindrical
TEC120B4-25C12-83	●	12	12	4	25	83	Cylindrical
TEC140B4-25C14-83	●	14	14	4	25	83	Cylindrical
TEC160B4-32C16-92	●	16	16	4	32	92	Cylindrical
TEC180B4-32C18-92	●	18	18	4	32	92	Cylindrical
TEC200B4-38C20-104	●	20	20	4	38	104	Cylindrical

● : Line up

TEC**B4**R

4 flute radius endmill, 45° helix angle

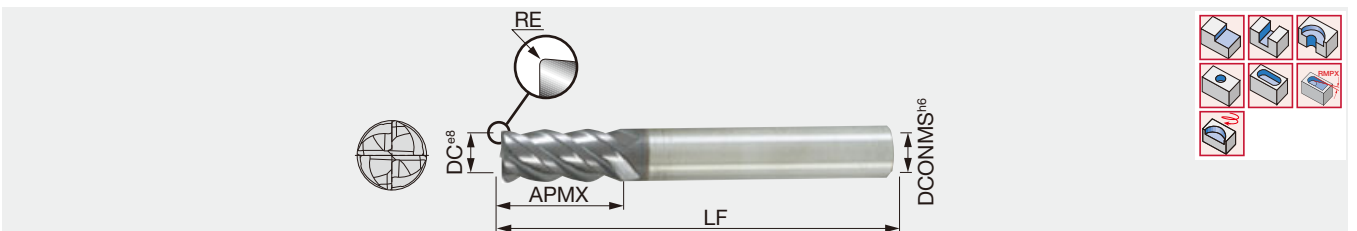

Designation	AH725	DC	DCONMS	NOF	RE	APMX	LF	Shank
TEC060B4-16C06R05-57	●	6	6	4	0.5	16	57	Cylindrical
TEC060B4-16C06R1-57	●	6	6	4	1	16	57	Cylindrical
TEC080B4-20C08R05-63	●	8	8	4	0.5	20	63	Cylindrical
TEC080B4-20C08R1-63	●	8	8	4	1	20	63	Cylindrical
TEC080B4-20C08R15-63	●	8	8	4	1.5	20	63	Cylindrical
TEC080B4-20C08R2-63	●	8	8	4	2	20	63	Cylindrical
TEC100B4-22C10R05-72	●	10	10	4	0.5	22	72	Cylindrical
TEC100B4-22C10R1-72	●	10	10	4	1	22	72	Cylindrical
TEC100B4-22C10R15-72	●	10	10	4	1.5	22	72	Cylindrical
TEC100B4-22C10R2-72	●	10	10	4	2	22	72	Cylindrical
TEC100B4-22C10R3-72	●	10	10	4	3	22	72	Cylindrical
TEC120B4-25C12R05-83	●	12	12	4	0.5	25	83	Cylindrical
TEC120B4-25C12R1-83	●	12	12	4	1	25	83	Cylindrical
TEC120B4-25C12R15-83	●	12	12	4	1.5	25	83	Cylindrical
TEC120B4-25C12R2-83	●	12	12	4	2	25	83	Cylindrical
TEC120B4-25C12R3-83	●	12	12	4	3	25	83	Cylindrical
TEC160B4-32C16R05-92	●	16	16	4	0.5	32	92	Cylindrical
TEC160B4-32C16R1-92	●	16	16	4	1	32	92	Cylindrical
TEC160B4-32C16R2-92	●	16	16	4	2	32	92	Cylindrical
TEC160B4-32C16R3-92	●	16	16	4	3	32	92	Cylindrical
TEC200B4-38C20R05-104	●	20	20	4	0.5	38	104	Cylindrical
TEC200B4-38C20R1-104	●	20	20	4	1	38	104	Cylindrical
TEC200B4-38C20R2-104	●	20	20	4	2	38	104	Cylindrical
TEC200B4-38C20R3-104	●	20	20	4	3	38	104	Cylindrical
TEC200B4-38C20R4-104	●	20	20	4	4	38	104	Cylindrical

● : Line up

Reference pages: Standard cutting conditions → I047

2 flute rib processing endmill, 30° helix angle, for hardened steel up to 55 HRC

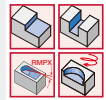
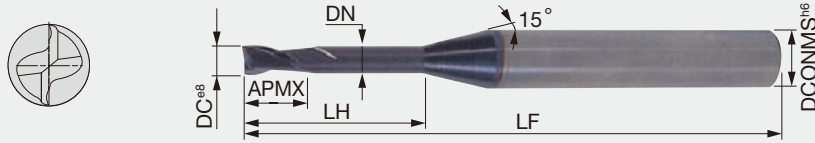

Designation	AH750	DC	DCONMS	NOF	DN	APMX	LH	LF	Shank
TEC004A2-006/02C4M45	●	0.4	4	2	0.37	0.6	2	45	Cylindrical
TEC004A2-006/04C4M45	●	0.4	4	2	0.37	0.6	4	45	Cylindrical
TEC005A2-007/02C4M45	●	0.5	4	2	0.45	0.7	2	45	Cylindrical
TEC005A2-007/04C4M45	●	0.5	4	2	0.45	0.7	4	45	Cylindrical
TEC005A2-007/06C4M45	●	0.5	4	2	0.45	0.7	6	45	Cylindrical
TEC006A2-009/02C4M45	●	0.6	4	2	0.55	0.9	2	45	Cylindrical
TEC006A2-009/04C4M45	●	0.6	4	2	0.55	0.9	4	45	Cylindrical
TEC006A2-009/06C4M45	●	0.6	4	2	0.55	0.9	6	45	Cylindrical
TEC007A2-010/02C4M45	●	0.7	4	2	0.65	1	2	45	Cylindrical
TEC008A2-012/04C4M45	●	0.8	4	2	0.75	1.2	4	45	Cylindrical
TEC008A2-012/06C4M45	●	0.8	4	2	0.75	1.2	6	45	Cylindrical
TEC008A2-012/08C4M45	●	0.8	4	2	0.75	1.2	8	45	Cylindrical
TEC009A2-0135/06C4M45	●	0.9	4	2	0.85	1.35	6	45	Cylindrical
TEC009A2-0135/10C4M45	●	0.9	4	2	0.85	1.35	10	45	Cylindrical
TEC010A2-015/04C4M45	●	1	4	2	0.97	1.5	4	45	Cylindrical
TEC010A2-015/06C4M45	●	1	4	2	0.97	1.5	6	45	Cylindrical
TEC010A2-015/08C4M45	●	1	4	2	0.95	1.5	8	45	Cylindrical
TEC010A2-015/10C4M45	●	1	4	2	0.95	1.5	10	45	Cylindrical
TEC010A2-015/12C4M45	●	1	4	2	0.93	1.5	12	45	Cylindrical
TEC010A2-015/16C4M50	●	1	4	2	0.93	1.5	16	50	Cylindrical
TEC012A2-018/06C4M45	●	1.2	4	2	1.17	1.8	6	45	Cylindrical
TEC012A2-018/08C4M45	●	1.2	4	2	1.15	1.8	8	45	Cylindrical
TEC012A2-018/10C4M45	●	1.2	4	2	1.15	1.8	10	45	Cylindrical
TEC012A2-018/16C4M50	●	1.2	4	2	1.13	1.8	16	50	Cylindrical
TEC014A2-021/06C4M45	●	1.4	4	2	1.35	2.1	6	45	Cylindrical
TEC014A2-021/08C4M45	●	1.4	4	2	1.35	2.1	8	45	Cylindrical
TEC014A2-021/10C4M45	●	1.4	4	2	1.35	2.1	10	45	Cylindrical
TEC015A2-023/06C4M45	●	1.5	4	2	1.47	2.3	6	45	Cylindrical
TEC015A2-023/08C4M45	●	1.5	4	2	1.45	2.3	8	45	Cylindrical
TEC015A2-023/10C4M45	●	1.5	4	2	1.45	2.3	10	45	Cylindrical
TEC015A2-023/12C4M45	●	1.5	4	2	1.43	2.3	12	45	Cylindrical
TEC015A2-023/16C4M50	●	1.5	4	2	1.41	2.3	16	50	Cylindrical
TEC015A2-023/18C4M55	●	1.5	4	2	1.41	2.3	18	55	Cylindrical
TEC015A2-023/20C4M55	●	1.5	4	2	1.41	2.3	20	55	Cylindrical
TEC016A2-024/06C4M45	●	1.6	4	2	1.57	2.4	6	45	Cylindrical
TEC016A2-024/08C4M45	●	1.6	4	2	1.55	2.4	8	45	Cylindrical
TEC016A2-024/10C4M45	●	1.6	4	2	1.55	2.4	10	45	Cylindrical
TEC016A2-024/18C4M55	●	1.6	4	2	1.53	2.4	18	55	Cylindrical
TEC016A2-024/20C4M55	●	1.6	4	2	1.53	2.4	20	55	Cylindrical
TEC016A2-024/26C4M60	●	1.6	4	2	1.53	2.4	26	60	Cylindrical
TEC018A2-027/06C4M45	●	1.8	4	2	1.77	2.7	6	45	Cylindrical
TEC018A2-027/08C4M45	●	1.8	4	2	1.75	2.7	8	45	Cylindrical
TEC018A2-027/10C4M45	●	1.8	4	2	1.75	2.7	10	45	Cylindrical
TEC018A2-027/12C4M45	●	1.8	4	2	1.73	2.7	12	45	Cylindrical
TEC020A2-030/06C4M45	●	2	4	2	1.97	3	6	45	Cylindrical
TEC020A2-030/08C4M45	●	2	4	2	1.95	3	8	45	Cylindrical
TEC020A2-030/10C4M45	●	2	4	2	1.95	3	10	45	Cylindrical
TEC020A2-030/12C4M45	●	2	4	2	1.93	3	12	45	Cylindrical
TEC020A2-030/16C4M50	●	2	4	2	1.91	3	16	50	Cylindrical

● : Line up

Reference pages: Standard cutting conditions → **I047**

Designation	AH750	DC	DCONMS	NOF	DN	APMX	LH	LF	Shank
TEC020A2-030/20C4M55	●	2	4	2	1.89	3	20	55	Cylindrical
TEC020A2-030/30C4M70	●	2	4	2	1.89	3	30	70	Cylindrical
TEC025A2-037/08C4M45	●	2.5	4	2	2.4	3.7	8	45	Cylindrical
TEC025A2-037/10C4M45	●	2.5	4	2	2.4	3.7	10	45	Cylindrical
TEC025A2-037/12C4M45	●	2.5	4	2	2.4	3.7	12	45	Cylindrical
TEC025A2-037/16C4M55	●	2.5	4	2	2.4	3.7	16	55	Cylindrical
TEC025A2-037/20C4M60	●	2.5	4	2	2.4	3.7	20	60	Cylindrical
TEC025A2-037/30C4M80	●	2.5	4	2	2.4	3.7	30	80	Cylindrical
TEC030A2-045/08C6M45	●	3	6	2	2.85	4.5	8	45	Cylindrical
TEC030A2-045/10C6M45	●	3	6	2	2.85	4.5	10	45	Cylindrical
TEC030A2-045/12C6M45	●	3	6	2	2.85	4.5	12	45	Cylindrical
TEC030A2-045/16C6M55	●	3	6	2	2.85	4.5	16	55	Cylindrical
TEC030A2-045/20C6M60	●	3	6	2	2.85	4.5	20	60	Cylindrical
TEC030A2-045/30C6M70	●	3	6	2	2.85	4.5	30	70	Cylindrical
TEC030A2-045/40C6M90	●	3	6	2	2.85	4.5	40	90	Cylindrical

● : Line up

SOLIDMEISTER

TEC**A4

4 flute endmill, 30° helix angle, for hardened steel up to 65 HRC

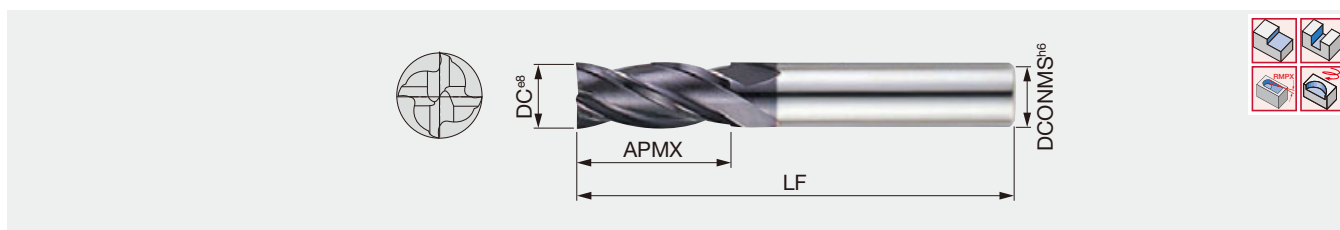

Designation	AH750	DC	DCONMS	NOF	APMX	LF	Shank
TEC040A4-11C06-50	●	4	6	4	11	50	Cylindrical
TEC050A4-13C06-50	●	5	6	4	13	50	Cylindrical
TEC060A4-13C06-50	●	6	6	4	13	50	Cylindrical
TEC070A4-16C08-63	●	7	8	4	16	63	Cylindrical
TEC080A4-19C08-63	●	8	8	4	19	63	Cylindrical
TEC090A4-19C10-72	●	9	10	4	19	72	Cylindrical
TEC100A4-22C10-72	●	10	10	4	22	72	Cylindrical
TEC120A4-26C12-73	●	12	12	4	26	73	Cylindrical
TEC140A4-26C14-83	●	14	14	4	26	83	Cylindrical
TEC160A4-32C16-92	●	16	16	4	32	92	Cylindrical
TEC180A4-32C18-100	●	18	18	4	32	100	Cylindrical
TEC200A4-38C20-104	●	20	20	4	38	104	Cylindrical

● : Line up

Reference pages: Standard cutting conditions → **I047**

Grade
Insert
Ext. Toolholder
Int. Toolholder
Threading
Grooving
Miniature tool
Milling cutter
Endmill
Drilling tool
Tooling System
User's Guide
Index

A
B
C
D
E
F
G
H
I
J
K
L
M

6 flute endmill, 45° helix angle, for finishing operation

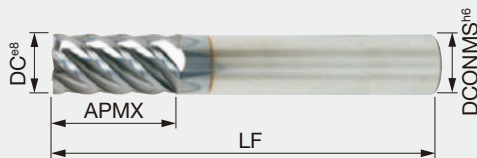

Designation	AH725	AH750	DC	DCONMS	NOF	APMX	LF	Shank
TECH060B6-16C06-57	●	●	6	6	6	16	57	Cylindrical
TECH060B6-16W06-57	●		6	6	6	16	57	Weldon
TECH080B6-20C08-63	●	●	8	8	6	20	63	Cylindrical
TECH080B6-20W08-63	●		8	8	6	20	63	Weldon
TECH100B6-22C10-72	●	●	10	10	6	22	72	Cylindrical
TECH100B6-22W10-72	●		10	10	6	22	72	Weldon
TECH120B6-25C12-83	●	●	12	12	6	25	83	Cylindrical
TECH120B6-25W12-83	●		12	12	6	25	83	Weldon
TECH160B6-32C16-92	●	●	16	16	6	32	92	Cylindrical
TECH160B6-32W16-92	●		16	16	6	32	92	Weldon
TECH200B6-38C20-104	●	●	20	20	6	38	104	Cylindrical
TECH200B6-38W20-104	●		20	20	6	38	104	Weldon

● : Line up

TECB6**

6 flute endmill, 45° helix angle, extra long neck type, for hardened steel up to 65 HRC

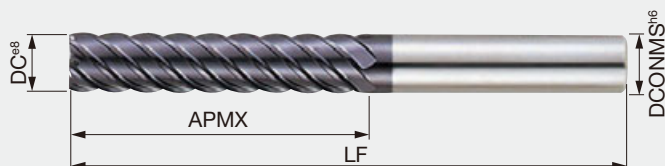

Designation	AH750	DC	DCONMS	NOF	APMX	LF	Shank
TEC060B6-26C06-70	●	6	6	6	26	70	Cylindrical
TEC080B6-36C08-90	●	8	8	6	36	90	Cylindrical
TEC100B6-46C10-100	●	10	10	6	46	100	Cylindrical
TEC120B6-56C12-110	●	12	12	6	56	110	Cylindrical
TEC160B6-66C16-130	●	16	16	6	66	130	Cylindrical
TEC200B6-76C20-140	●	20	20	6	76	140	Cylindrical
TEC250B6-92C25-180	●	25	25	6	92	180	Cylindrical

● : Line up

Reference pages: Standard cutting conditions → [I047](#)

TEC**D6

6 flute endmill, 50° helix angle, for hardened steel up to 65 HRC

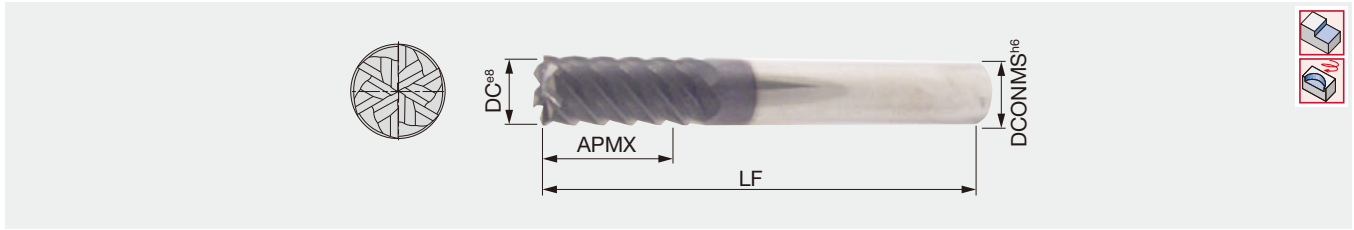

Designation	AH750	DC	DCONMS	NOF	APMX	LF	Shank
TEC060D6-13C06H57	●	6	6	6	13	57	Cylindrical
TEC080D6-20C08H63	●	8	8	6	20	63	Cylindrical
TEC100D6-22C10H72	●	10	10	6	22	72	Cylindrical
TEC120D6-25C12H83	●	12	12	6	25	83	Cylindrical
TEC140D6-30C14H83	●	14	14	6	30	83	Cylindrical
TEC160D6-32C16H92	●	16	16	6	32	92	Cylindrical
TEC200D6-38C20H104	●	20	20	6	38	104	Cylindrical

● : Line up

TECA**B2

2 flute slotting endmill, 45° helix angle, for aluminium machining

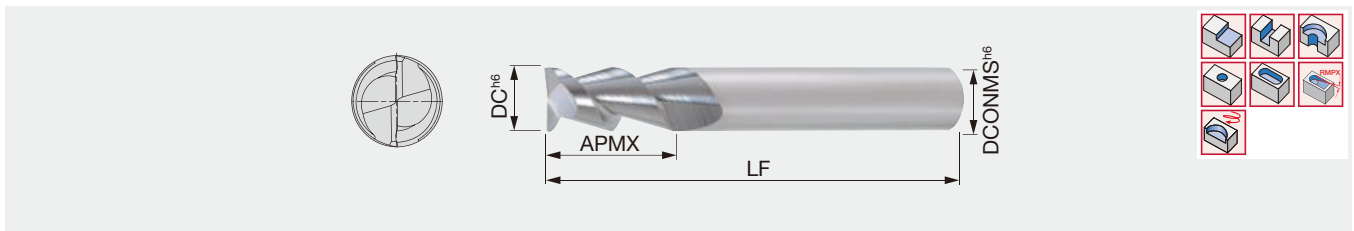

Designation	KS15F	DC	DCONMS	NOF	APMX	LF	Shank
TECA040B2-12C06-57	●	4	6	2	12	57	Cylindrical
TECA050B2-14C06-57	●	5	6	2	14	57	Cylindrical
TECA060B2-16C06-57	●	6	6	2	16	57	Cylindrical
TECA080B2-20C08-63	●	8	8	2	20	63	Cylindrical
TECA100B2-22C10-72	●	10	10	2	22	72	Cylindrical
TECA120B2-25C12-83	●	12	12	2	25	83	Cylindrical
TECA160B2-32C16-92	●	16	16	2	32	92	Cylindrical
TECA200B2-38C20-104	●	20	20	2	38	104	Cylindrical

● : Line up

Reference pages: Standard cutting conditions → [I047](#)

3 flute endmill, 45° helix angle, for aluminium machining

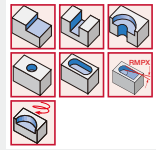
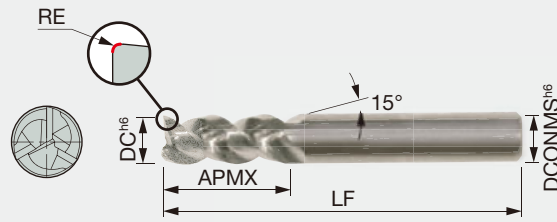

Designation	KS15F	DC	DCONMS	NOF	RE	APMX	LF	Shank
TECA040B3-12C06-57	●	4	6	3	0.1	12	57	Cylindrical
TECA040B3-12W06-57	●	4	6	3	0.1	12	57	Weldon
TECA050B3-14C06-57	●	5	6	3	0.2	14	57	Cylindrical
TECA050B3-14W06-57	●	5	6	3	0.2	14	57	Weldon
TECA060B3-16C06-57	●	6	6	3	0.2	16	57	Cylindrical
TECA060B3-16W06-57	●	6	6	3	0.2	16	57	Weldon
TECA080B3-20C08-63	●	8	8	3	0.2	20	63	Cylindrical
TECA080B3-20C08R30-63	●	8	8	3	3	20	63	Cylindrical
TECA080B3-20W08-63	●	8	8	3	0.2	20	63	Weldon
TECA100B3-22C10-72	●	10	10	3	0.2	22	72	Cylindrical
TECA100B3-22W10-72	●	10	10	3	0.2	22	72	Weldon
TECA100B3-25C10R30-72	●	10	10	3	3	25	72	Cylindrical
TECA100B3-25C10R40-72	●	10	10	3	4	25	72	Cylindrical
TECA120B3-25C12-83	●	12	12	3	0.2	25	83	Cylindrical
TECA120B3-25W12-83	●	12	12	3	0.2	25	83	Weldon
TECA120B3-30C12R30-83	●	12	12	3	3	30	83	Cylindrical
TECA120B3-30C12R40-83	●	12	12	3	4	30	83	Cylindrical
TECA140B3-30C14-83	●	14	14	3	0.2	30	83	Cylindrical
TECA140B3-30W14-83	●	14	14	3	0.2	30	83	Weldon
TECA160B3-32C16-92	●	16	16	3	0.2	32	92	Cylindrical
TECA160B3-32W16-92	●	16	16	3	0.2	32	92	Weldon
TECA200B3-38C20-104	●	20	20	3	0.2	38	104	Cylindrical
TECA200B3-38W20-104	●	20	20	3	0.2	38	104	Weldon

● : Line up

TECAF2**

2 flute slotting endmill, 55° helix angle, for aluminium machining

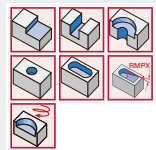
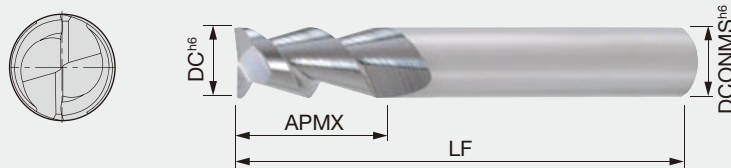

Designation	KS15F	DC	DCONMS	NOF	APMX	LF	Shank
TECA040F2-11C04-50	●	4	4	2	11	50	Cylindrical
TECA060F2-13C06-57	●	6	6	2	13	57	Cylindrical
TECA080F2-20C08-63	●	8	8	2	20	63	Cylindrical
TECA100F2-22C10-72	●	10	10	2	22	72	Cylindrical
TECA120F2-25C12-83	●	12	12	2	25	83	Cylindrical
TECA160F2-32C16-92	●	16	16	2	32	92	Cylindrical
TECA200F2-38C20-104	●	20	20	2	38	104	Cylindrical
TECA250F2-45C25-121	●	25	25	2	45	121	Cylindrical

● : Line up

Reference pages: Standard cutting conditions → [I047](#)

2 flute endmill, 30° helix angle, short type

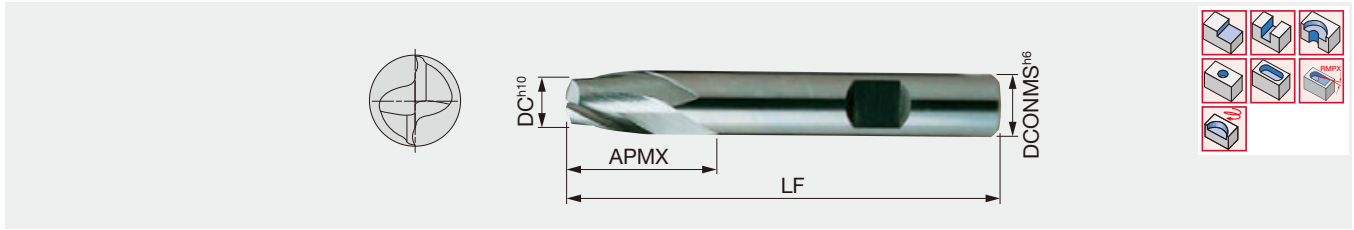

Designation	AH725	DC	DCONMS	NOF	APMX	LF	Shank
TEC020A2-03W06-E50	●	2	6	2	3	50	Weldon
TEC030A2-04W06-E50	●	3	6	2	4	50	Weldon
TEC040A2-05W06-E54	●	4	6	2	5	54	Weldon
TEC045A2-05W06-E54	●	4.5	6	2	5	54	Weldon
TEC050A2-06W06-E54	●	5	6	2	6	54	Weldon
TEC060A2-07W06-E54	●	6	6	2	7	54	Weldon
TEC080A2-09W08-E58	●	8	8	2	9	58	Weldon
TEC100A2-11W10-E66	●	10	10	2	11	66	Weldon
TEC180A2-18W18-E84	●	18	18	2	18	84	Weldon
TEC200A2-20W20-E92	●	20	20	2	20	92	Weldon

● : Line up

TEC**A2**E

2 flute endmill, 30° helix angle

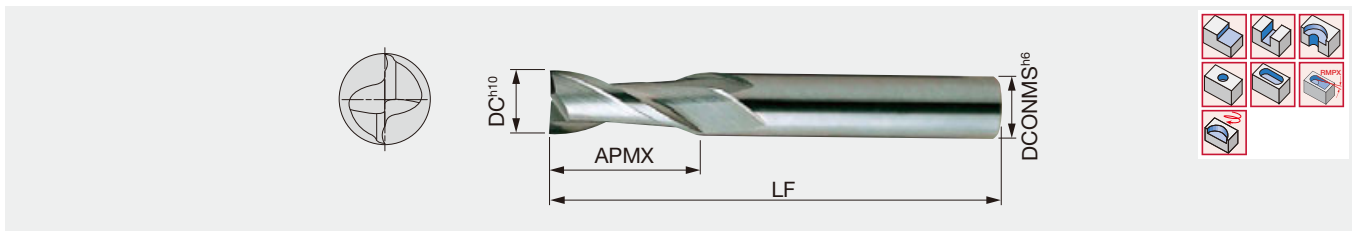

Designation	AH725	DC	DCONMS	NOF	APMX	LF	Shank
TEC010A2-03C04-E50	●	1	4	2	3	50	Cylindrical
TEC015A2-045C04-E50	●	1.5	4	2	4.5	50	Cylindrical
TEC020A2-08C02-E32	●	2	2	2	8	32	Cylindrical
TEC025A2-08C025-E32	●	2.5	2.5	2	8	32	Cylindrical
TEC030A2-12C03-E38	●	3	3	2	12	38	Cylindrical
TEC035A2-12C035-E32	●	3.5	3.5	2	12	32	Cylindrical
TEC040A2-12C04-E50	●	4	4	2	12	50	Cylindrical
TEC050A2-14C05-E50	●	5	5	2	14	50	Cylindrical
TEC055A2-16C055-E50	●	5.5	5.5	2	16	50	Cylindrical
TEC060A2-16C06-E50	●	6	6	2	16	50	Cylindrical
TEC070A2-20C07-E60	●	7	7	2	20	60	Cylindrical
TEC080A2-20C08-E63	●	8	8	2	20	63	Cylindrical
TEC090A2-20C09-E60	●	9	9	2	20	60	Cylindrical
TEC100A2-22C10-E72	●	10	10	2	22	72	Cylindrical
TEC120A2-22C12-E73	●	12	12	2	22	73	Cylindrical
TEC140A2-25C14-E75	●	14	14	2	25	75	Cylindrical
TEC160A2-25C16-E92	●	16	16	2	25	92	Cylindrical
TEC200A2-32C20-E100	●	20	20	2	32	100	Cylindrical

● : Line up

Reference pages: Standard cutting conditions → [I047](#)

3 flute endmill, 30° or 38° helix angle, short type

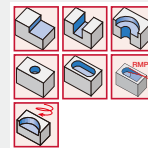
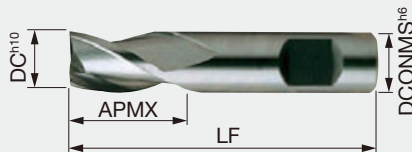

Designation	AH725	DC	DCONMS	NOF	APMX	LF	FHA	Shank
TEC020E3-04C06-E35	●	2	6	3	4	35	38°	Cylindrical
TEC025E3-05C06-E36	●	2.5	6	3	5	36	38°	Cylindrical
TEC030E3-05C06-E36	●	3	6	3	5	36	38°	Cylindrical
TEC035A3-06W06-E37	●	3.5	6	3	6	37	30°	Weldon
TEC040E3-07C06-E39	●	4	6	3	7	39	38°	Cylindrical
TEC045A3-08W06-E38	●	4.5	6	3	8	38	30°	Weldon
TEC050A3-08C06-E39	●	5	6	3	8	39	30°	Cylindrical
TEC055A3-08W06-E39	●	5.5	6	3	8	39	30°	Weldon
TEC060E3-08C06-E39	●	6	6	3	8	39	38°	Cylindrical
TEC070A3-10W08-E42	●	7	8	3	10	42	30°	Weldon
TEC080E3-11C08-E43	●	8	8	3	11	43	38°	Cylindrical
TEC090A3-11W10-E48	●	9	10	3	11	48	30°	Weldon
TEC100E3-13C10-E50	●	10	10	3	13	50	38°	Cylindrical

● : Line up

TECA/E3**E**

3 flute endmill, 30° or 38° helix angle

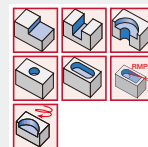
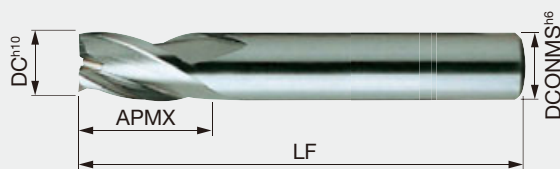

Designation	AH725	DC	DCONMS	NOF	APMX	LF	FHA	Shank
TEC020E3-08C02-E32	●	2	2	3	8	32	38°	Cylindrical
TEC030E3-12C03-E38	●	3	3	3	12	38	38°	Cylindrical
TEC040E3-12C04-E50	●	4	4	3	12	50	38°	Cylindrical
TEC050E3-14C05-E50	●	5	5	3	14	50	38°	Cylindrical
TEC060E3-16C06-E50	●	6	6	3	16	50	38°	Cylindrical
TEC070E3-20C07-E60	●	7	7	3	20	60	38°	Cylindrical
TEC080E3-20C08-E63	●	8	8	3	20	63	38°	Cylindrical
TEC090A3-20C09-E60	●	9	9	3	20	60	30°	Cylindrical
TEC100E3-22C10-E72	●	10	10	3	22	72	38°	Cylindrical
TEC120E3-22C12-E73	●	12	12	3	22	73	38°	Cylindrical
TEC140A3-25C14-E75	●	14	14	3	25	75	30°	Cylindrical
TEC160A3-25C16-E75	●	16	16	3	25	75	30°	Cylindrical

● : Line up

Reference pages: Standard cutting conditions → **I047**

TEC**B3**W

3 flute endmill, 45° helix angle, short type

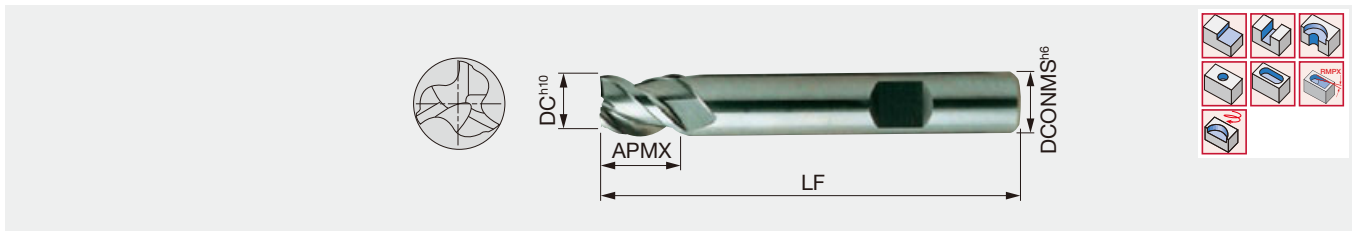

Designation	AH725	DC	DCONMS	NOF	APMX	LF	Shank
TEC020B3-03W06-50	●	2	6	3	3	50	Weldon
TEC030B3-04W06-50	●	3	6	3	4	50	Weldon
TEC040B3-05W06-54	●	4	6	3	5	54	Weldon
TEC050B3-06W06-54	●	5	6	3	6	54	Weldon
TEC060B3-07W06-54	●	6	6	3	7	54	Weldon
TEC080B3-09W08-58	●	8	8	3	9	58	Weldon
TEC100B3-11W10-66	●	10	10	3	11	66	Weldon
TEC120B3-12W12-73	●	12	12	3	12	73	Weldon
TEC140B3-14W14-75	●	14	14	3	14	75	Weldon
TEC160B3-16W16-82	●	16	16	3	16	82	Weldon
TEC200B3-20W20-92	●	20	20	3	20	92	Weldon

● : Line up

TEC**A4**E

4 flute endmill, 30° helix angle

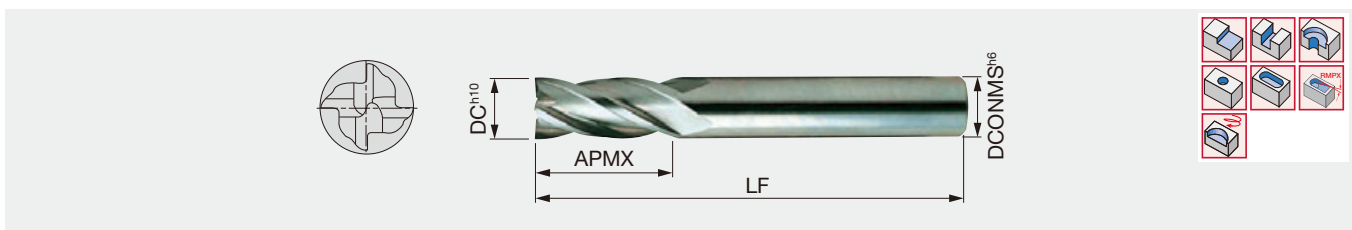

Designation	AH725	DC	DCONMS	NOF	APMX	LF	Shank
TEC020A4-08C02-E32	●	2	2	4	8	32	Cylindrical
TEC025A4-08C025-E32	●	2.5	2.5	4	8	32	Cylindrical
TEC030A4-12C03-E38	●	3	3	4	12	38	Cylindrical
TEC040A4-12C04-E50	●	4	4	4	12	50	Cylindrical
TEC050A4-14C05-E50	●	5	5	4	14	50	Cylindrical
TEC055A4-16C055-E50	●	5.5	5.5	4	16	50	Cylindrical
TEC060A4-16C06-E50	●	6	6	4	16	50	Cylindrical
TEC070A4-20C07-E60	●	7	7	4	20	60	Cylindrical
TEC080A4-20C08-E60	●	8	8	4	20	60	Cylindrical
TEC090A4-20C09-E60	●	9	9	4	20	60	Cylindrical
TEC100A4-22C10-E72	●	10	10	4	22	72	Cylindrical
TEC120A4-22C12-E73	●	12	12	4	22	73	Cylindrical
TEC140A4-25C14-E83	●	14	14	4	25	83	Cylindrical
TEC160A4-25C16-E82	●	16	16	4	25	82	Cylindrical
TEC200A4-32C20-E104	●	20	20	4	32	104	Cylindrical

● : Line up

Reference pages: Standard cutting conditions → [I047](#)

4 flute endmill, 30° helix angle, extra long neck type

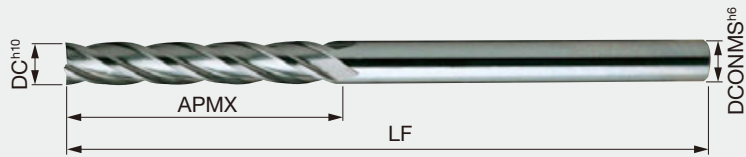
**Designation****AH725****DC****DCONMS****NOF****APMX****LF****Shank**

TEC030A4-30C03-E75	●	3	3	4	30	75	Cylindrical
TEC040A4-30C04-E75	●	4	4	4	30	75	Cylindrical
TEC050A4-40C05-E100	●	5	5	4	40	100	Cylindrical
TEC060A4-50C06-E150	●	6	6	4	50	150	Cylindrical
TEC080A4-50C08-E150	●	8	8	4	50	150	Cylindrical
TEC100A4-60C10-E150	●	10	10	4	60	150	Cylindrical
TEC120A4-75C12-E150	●	12	12	4	75	150	Cylindrical
TEC140A4-65C14-E150	●	14	14	4	65	150	Cylindrical
TEC160A4-65C16-E150	●	16	16	4	65	150	Cylindrical
TEC200A4-65C20-E150	●	20	20	4	65	150	Cylindrical

● : Line up

Reference pages: Standard cutting conditions → **I047**

STANDARD CUTTING CONDITIONS

Slotting / Roughing

ISO	Workpiece material	Hardness	Vc (m/min)	fz (mm/t)			ap (Slotting)
				ø6 - ø8	ø10 - ø12	ø16 - ø20	
P	Carbon steel	- 300 HB	140 - 180	0.025 - 0.035	0.03 - 0.045	0.04 - 0.055	1xD
	Alloy steel	- 300 HB	70 - 150	0.02 - 0.03	0.03 - 0.045	0.04 - 0.055	1xD
M	Stainless steel	- 200 HB	60 - 100	0.02 - 0.035	0.03 - 0.04	0.035 - 0.045	0.5xD
K	Cast iron	150 - 250 HB	80 - 180	0.02 - 0.04	0.03 - 0.05	0.04 - 0.06	1xD
N	Aluminium alloy	-	300 - 750	0.02 - 0.04	0.03 - 0.05	0.03 - 0.07	1xD
S	Titanium alloy	-	20 - 50	0.02 - 0.03	0.025 - 0.04	0.03 - 0.07	0.25xD
H	Hardened steel	- 60 HRC	20 - 30	0.01 - 0.015	0.02 - 0.045	0.04 - 0.05	0.2xD

Semi-finishing / Shouldering (ae = 0.1-0.4 x D)

ISO	Workpiece material	Hardness	Vc (m/min)	fz (mm/t)			ap
				ø6 - ø8	ø10 - ø12	ø16 - ø20	
P	Carbon steel	- 300 HB	150 - 220	0.03 - 0.06	0.06 - 0.07	0.07 - 0.08	2xD
	Alloy steel	- 300 HB	70 - 160	0.02 - 0.05	0.04 - 0.065	0.045 - 0.07	2xD
M	Stainless steel	- 200 HB	80 - 130	0.025 - 0.04	0.035 - 0.045	0.04 - 0.05	2xD
K	Cast iron	150 - 250 HB	130 - 220	0.03 - 0.05	0.04 - 0.06	0.06 - 0.07	2xD
N	Aluminium alloy	-	350 - 850	0.04 - 0.06	0.06 - 0.08	0.08 - 0.1	2xD
S	Titanium alloy	-	40 - 60	0.03 - 0.04	0.035 - 0.05	0.05 - 0.08	2xD
H	Hardened steel	- 60 HRC	30 - 70	0.015 - 0.035	0.035 - 0.055	0.045 - 0.06	2xD

Finishing (feed rate depending on required accuracy) / High feed machining at low depth of cut (ae = 0.05-0.1 x D)

ISO	Workpiece material	Hardness	Vc (m/min)	fz (mm/t)			ap
				ø6 - ø8	ø10 - ø12	ø16 - ø20	
P	Carbon steel	- 300 HB	170 - 280	0.05 - 0.07	0.07 - 0.08	0.08 - 0.1	apmax
	Alloy steel	- 300 HB	110 - 220	0.05 - 0.07	0.07 - 0.08	0.08 - 0.1	apmax
M	Stainless steel	- 200 HB	100 - 160	0.03 - 0.045	0.04 - 0.05	0.045 - 0.06	apmax
K	Cast iron	150 - 250 HB	180 - 280	0.035 - 0.06	0.06 - 0.065	0.065 - 0.08	apmax
N	Aluminium alloy	-	350 - 900	0.045 - 0.07	0.07 - 0.1	0.1 - 0.15	apmax
S	Titanium alloy	-	50 - 70	0.035 - 0.05	0.04 - 0.06	0.06 - 0.085	apmax
H	Hardened steel	- 60 HRC	40 - 80	0.02 - 0.04	0.04 - 0.06	0.05 - 0.07	apmax

- When the depth of cut (ae) is closer to the upper limit, please start with a lower limit value of cutting speed (Vc).
- The items with long slot (2xD or over) and the items with 5 cutting edges or more are not suitable for slotting operation.
- When using AH750, reducing cutting speed by 20 to 30% is effective for extending tool life.
- While air blow is recommended, water-soluble coolant will be good for stainless steel, titanium alloy, and heat-resistant alloy.
- When chattering occurs with low rigid machines or settings, reduce cutting speed and feed at an equal rate.
- When chattering occurs with long tool overhang, reduce cutting speed and feed by 20 to 40% (Variable/FinishMeister is recommended for such operations).
- In slotting of high hardened steel, heat-resistant alloy, and some types of stainless steel, start with ap=0.2xD and increase the value gradually while checking the status of the operation.
- In shoulder milling of high hardened steel and heat-resistant alloy, the cutting width should be started at ae=0.05xD and increase the value gradually while checking the status of the operation.
- The items with many cutting edges are good for finishing and high feed machining of small width of cut.
- VariableMeister is suitable for machining large depth of cut.
- Low feed in finishing is recommended for good surface roughness.



VARIABLEMEISTER**TEB**E4L**CF**

4 flute chatter dampening ball nose endmill (2xD), 38°helix angle, variable pitch, relieved neck type, for hardened steel



Designation	AH710	DC	DCONMS	NOF	APMX	LH	LF	Shank
TEB030E4L-06/09C06CFH57	●	3	6	4	6	9	57	Cylindrical
TEB040E4L-08/12C06CFH57	●	4	6	4	8	12	57	Cylindrical
TEB050E4L-10/15C06CFH57	●	5	6	4	10	15	57	Cylindrical
TEB060E4L-12/18C06CFH57	●	6	6	4	12	18	57	Cylindrical
TEB080E4L-16/24C08CFH63	●	8	8	4	16	24	63	Cylindrical
TEB100E4L-20/30C10CFH72	●	10	10	4	20	30	72	Cylindrical
TEB120E4L-24/36C12CFH83	●	12	12	4	24	36	83	Cylindrical
TEB160E4L-32/48C16CFH92	●	16	16	4	32	48	92	Cylindrical

● : Line up

**SHREDMEISTER****TEBRF**T3/4**

3 - 4 flute ball nose roughing endmill, 20° helix angle, long edge type, for hardened steel



Designation	AH750	DC	DCONMS	NOF	RE	APMX	LF	Shank
TEBRF060T3-16C06M57	●	6	6	3	3	16	57	Cylindrical
TEBRF080T3-16C08M63	●	8	8	3	4	16	63	Cylindrical
TEBRF100T4-22C10M72	●	10	10	4	5	22	72	Cylindrical
TEBRF120T4-26C12M83	●	12	12	4	6	26	83	Cylindrical
TEBRF140T4-26C14M83	●	14	14	4	7	26	83	Cylindrical
TEBRF160T4-32C16M92	●	16	16	4	8	32	92	Cylindrical
TEBRF180T4-32C18M92	●	18	18	4	9	32	92	Cylindrical
TEBRF200T4-38C20M104	●	20	20	4	10	38	104	Cylindrical

● : Line up

Reference pages: Standard cutting conditions → **I053**, Technical guide → **I054**

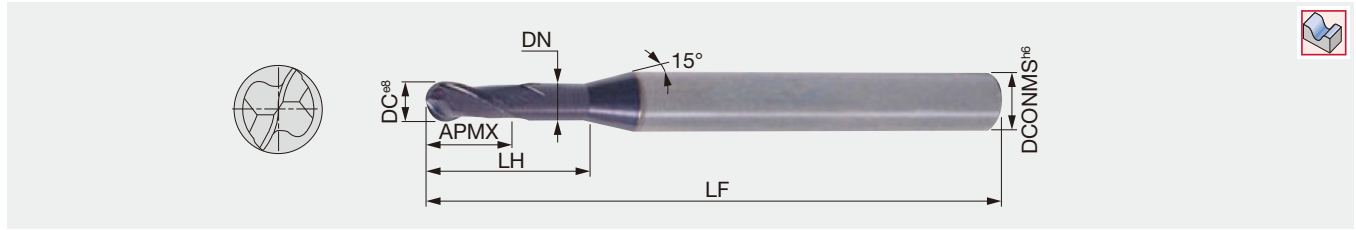

Designation	AH750	DC	DCONMS	NOF	DN	APMX	LH	LF	Shank
TEB004A2-006/02C4M45	●	0.4	4	2	0.36	0.6	2	45	Cylindrical
TEB004A2-006/03C4M45	●	0.4	4	2	0.36	0.6	3	45	Cylindrical
TEB005A2-007/02C4M45	●	0.5	4	2	0.45	0.7	2	45	Cylindrical
TEB005A2-007/04C4M45	●	0.5	4	2	0.45	0.7	4	45	Cylindrical
TEB005A2-007/06C4M45	●	0.5	4	2	0.45	0.7	6	45	Cylindrical
TEB006A2-009/02C4M45	●	0.6	4	2	0.55	0.9	2	45	Cylindrical
TEB006A2-009/04C4M45	●	0.6	4	2	0.55	0.9	4	45	Cylindrical
TEB008A2-012/04C4M45	●	0.8	4	2	0.75	1.2	4	45	Cylindrical
TEB008A2-012/06C4M45	●	0.8	4	2	0.75	1.2	6	45	Cylindrical
TEB010A2-015/04C4M45	●	1	4	2	0.97	1.5	4	45	Cylindrical
TEB010A2-015/06C4M45	●	1	4	2	0.97	1.5	6	45	Cylindrical
TEB010A2-015/08C4M45	●	1	4	2	0.95	1.5	8	45	Cylindrical
TEB010A2-015/10C4M45	●	1	4	2	0.95	1.5	10	45	Cylindrical
TEB010A2-015/12C4M45	●	1	4	2	0.93	1.5	12	45	Cylindrical
TEB010A2-015/16C4M50	●	1	4	2	0.93	1.5	16	50	Cylindrical
TEB012A2-018/08C4M45	●	1.2	4	2	1.17	1.8	8	45	Cylindrical
TEB012A2-018/12C4M45	●	1.2	4	2	1.13	1.8	12	45	Cylindrical
TEB014A2-021/08C4M45	●	1.4	4	2	1.35	2.1	8	45	Cylindrical
TEB014A2-021/16C4M50	●	1.4	4	2	1.31	2.1	16	50	Cylindrical
TEB015A2-023/06C4M45	●	1.5	4	2	1.47	2.3	6	45	Cylindrical
TEB015A2-023/08C4M45	●	1.5	4	2	1.45	2.3	8	45	Cylindrical
TEB015A2-023/10C4M45	●	1.5	4	2	1.45	2.3	10	45	Cylindrical
TEB015A2-023/12C4M45	●	1.5	4	2	1.43	2.3	12	45	Cylindrical
TEB015A2-023/20C4M55	●	1.5	4	2	1.39	2.3	20	55	Cylindrical
TEB016A2-024/08C4M45	●	1.6	4	2	1.55	2.4	8	45	Cylindrical
TEB016A2-024/12C4M45	●	1.6	4	2	1.53	2.4	12	45	Cylindrical
TEB018A2-027/08C4M45	●	1.8	4	2	1.75	2.7	8	45	Cylindrical
TEB018A2-027/12C4M45	●	1.8	4	2	1.73	2.7	12	45	Cylindrical
TEB018A2-027/16C4M50	●	1.8	4	2	1.71	2.7	16	50	Cylindrical
TEB020A2-030/06C4M45	●	2	4	2	1.97	3	6	45	Cylindrical
TEB020A2-030/10C4M45	●	2	4	2	1.93	3	10	45	Cylindrical
TEB020A2-030/12C4M50	●	2	4	2	1.93	3	12	50	Cylindrical
TEB020A2-030/16C4M50	●	2	4	2	1.91	3	16	50	Cylindrical
TEB020A2-030/20C4M55	●	2	4	2	1.89	3	20	55	Cylindrical
TEB020A2-030/30C4M70	●	2	4	2	1.89	3	30	70	Cylindrical
TEB030A2-045/08C6M50	●	3	6	2	2.85	4.5	8	50	Cylindrical
TEB030A2-045/10C6M50	●	3	6	2	2.85	4.5	10	50	Cylindrical
TEB030A2-045/12C6M50	●	3	6	2	2.85	4.5	12	50	Cylindrical
TEB030A2-045/16C6M55	●	3	6	2	2.85	4.5	16	55	Cylindrical
TEB030A2-045/20C6M60	●	3	6	2	2.85	4.5	20	60	Cylindrical
TEB030A2-045/30C6M70	●	3	6	2	2.85	4.5	30	70	Cylindrical
TEB030A2-045/35C6M80	●	3	6	2	2.85	4.5	35	80	Cylindrical

● : Line up



2 flute ball nose endmill, 30° helix angle, short type, for hardened steel

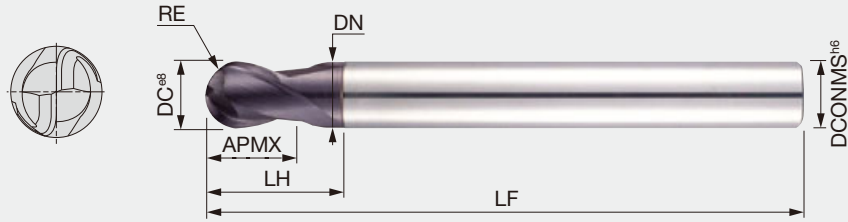

Designation	AH750	DC	DCONMS	NOF	DN	RE ^{±0.01}	APMX	LH	LF	Shank
TEB010A2-01/02C04H50	●	1	4	2	0.95	0.5	1	2.2	50	Cylindrical
TEB020A2-02/04C06H50	●	2	6	2	1.9	1	2	4	50	Cylindrical
TEB030A2-03/06C06H60	●	3	6	2	2.9	1.5	3	6	60	Cylindrical
TEB040A2-04/08C06H70	●	4	6	2	3.9	2	4	8	70	Cylindrical
TEB050A2-05/10C06H80	●	5	6	2	4.9	2.5	5	10	80	Cylindrical
TEB060A2-06/12C06H90	●	6	6	2	5.9	3	6	12	90	Cylindrical
TEB080A2-08/16C08H100	●	8	8	2	7.9	4	8	16	100	Cylindrical
TEB100A2-10/20C10H100	●	10	10	2	9.9	5	10	20	100	Cylindrical
TEB120A2-12/24C12H110	●	12	12	2	11.9	6	12	24	110	Cylindrical
TEB200A2-20/40C20H160	●	20	20	2	19.8	10	20	40	160	Cylindrical

● : Line up

TEBA2-**C**M...**

2 flute ball nose rib processing endmill, 30° helix angle, for hardened steel

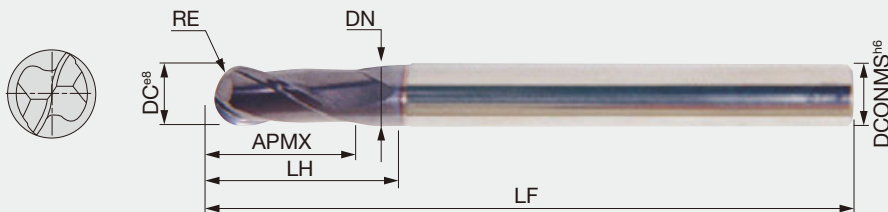

Designation	AH750	DC	DCONMS	NOF	DN	RE	APMX	LH	LF	Shank
TEB030A2-08C03M100	●	3	3	2	-	1.5	8	-	100	Cylindrical
TEB030A2-08C06M70	●	3	6	2	-	1.5	8	-	70	Cylindrical
TEB040A2-08C06M70	●	4	6	2	-	2	8	-	70	Cylindrical
TEB040A2-08C04M100	●	4	4	2	-	2	8	-	100	Cylindrical
TEB050A2-12C06M80	●	5	6	2	-	2.5	12	-	80	Cylindrical
TEB060A2-10C06M120	●	6	6	2	-	3	10	-	120	Cylindrical
TEB060A2-12/22C06M80	●	6	6	2	5.8	3	12	22	80	Cylindrical
TEB080A2-14/27C08M90	●	8	8	2	7.8	4	14	27	90	Cylindrical
TEB100A2-18/31C10M100	●	10	10	2	9.8	5	18	31	100	Cylindrical
TEB120A2-22/35C12M110	●	12	12	2	11.8	6	22	35	110	Cylindrical
TEB160A2-30/50C16M140	●	16	16	2	15.8	8	30	50	140	Cylindrical

● : Line up

Reference pages: Standard cutting conditions → [I053](#), Technical guide → [I054](#)

TEB**A2/**/**/**C**M...

2 flute ball nose endmill, 30° helix angle, tapered neck type, for hardened steel

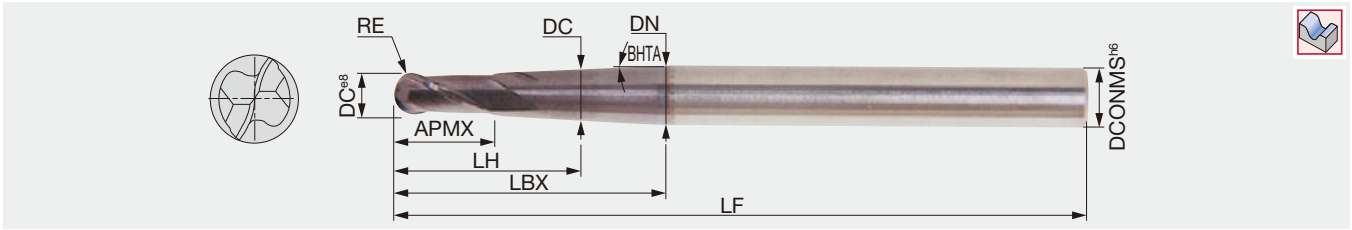

Designation	AH750	DC	DCONMS	NOF	DN	RE ^{+0.01}	APMX	LH	LBX	BHTA	LF	Shank
TEB010A2-02/04/3.0C06M80	●	1	6	2	5	0.5	2	4	42	3°	80	Cylindrical
TEB020A2-04/06/3.0C06M80	●	2	6	2	5.7	1	4	6	41	3°	80	Cylindrical
TEB030A2-06/08/3.0C06M70	●	3	6	2	5.6	1.5	6	8	32	3°	70	Cylindrical
TEB040A2-08/10/1.5C06M90	●	4	6	2	6	2	8	10	49	1.5°	90	Cylindrical
TEB050A2-10/12/1.5C08M110	●	5	8	2	7.6	2.5	10	12	61	1.5°	110	Cylindrical
TEB060A2-12/15/1.5C08M110	●	6	8	2	8	3	12	15	53	1.5°	110	Cylindrical
TEB080A2-14/17/1.5C10M120	●	8	10	2	10	4	14	17	55	1.5°	120	Cylindrical
TEB100A2-18/21/1.5C12M130	●	10	12	2	12	5	18	21	59	1.5°	130	Cylindrical

● : Line up

TEB**A2-**C**-...

2 flute ball nose endmill, 30° helix angle, short type

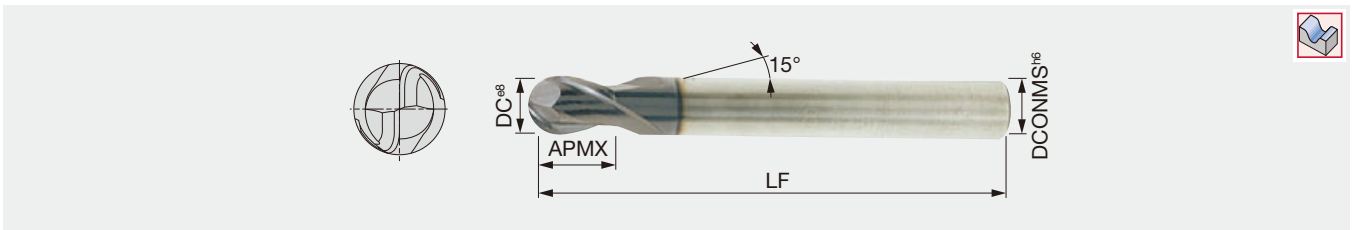

Designation	AH750	AH725	DC	DCONMS	NOF	APMX	LF	Shank
TEB030A2-05C06-57	●	●	3	6	2	5	57	Cylindrical
TEB040A2-07C06-57	●	●	4	6	2	7	57	Cylindrical
TEB050A2-08C06-57	●	●	5	6	2	8	57	Cylindrical
TEB060A2-08C06-57	●	●	6	6	2	8	57	Cylindrical
TEB080A2-11C08-63	●	●	8	8	2	11	63	Cylindrical
TEB100A2-13C10-72	●	●	10	10	2	13	72	Cylindrical
TEB120A2-14C12-83	●	●	12	12	2	14	83	Cylindrical
TEB160A2-16C16-92	●	●	16	16	2	16	92	Cylindrical
TEB200A2-20C20-104	●	●	20	20	2	20	104	Cylindrical

● : Line up

TEB**A3

3 flute ball nose endmill, 30° helix angle, short type

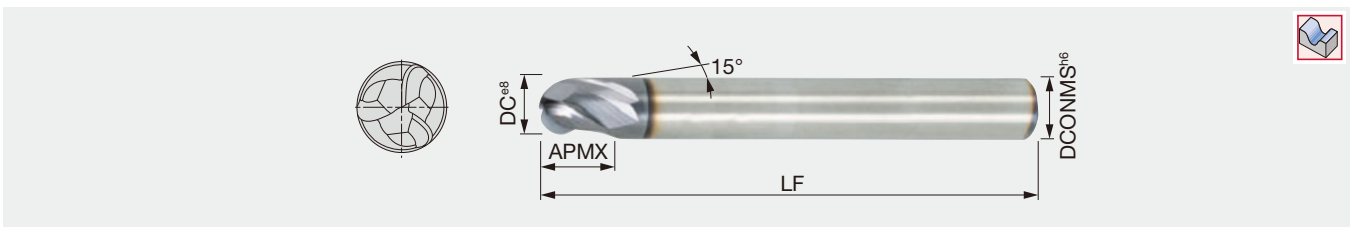

Designation	AH725	DC	DCONMS	NOF	APMX	LF	Shank
TEB030A3-05C06-57	●	3	6	3	5	57	Cylindrical
TEB040A3-07C06-57	●	4	6	3	7	57	Cylindrical
TEB050A3-08C06-57	●	5	6	3	8	57	Cylindrical
TEB060A3-08C06-57	●	6	6	3	8	57	Cylindrical
TEB080A3-11C08-63	●	8	8	3	11	63	Cylindrical
TEB100A3-13C10-72	●	10	10	3	13	72	Cylindrical
TEB120A3-14C12-83	●	12	12	3	14	83	Cylindrical

● : Line up

Reference pages: Standard cutting conditions → [I053](#), Technical guide → [I054](#)

4 flute ball nose endmill, 30° helix angle, short type

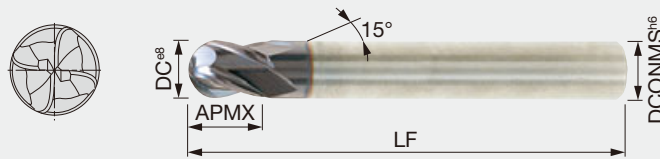

Designation	AH725	DC	DCONMS	NOF	APMX	LF	Shank
TEB030A4-05C06-57	●	3	6	4	5	57	Cylindrical
TEB040A4-07C06-50	●	4	6	4	7	50	Cylindrical
TEB050A4-08C06-57	●	5	6	4	8	57	Cylindrical
TEB060A4-08C06-57	●	6	6	4	8	57	Cylindrical
TEB080A4-11C08-63	●	8	8	4	11	63	Cylindrical
TEB100A4-13C10-72	●	10	10	4	13	72	Cylindrical
TEB120A4-14C12-83	●	12	12	4	14	83	Cylindrical
TEB200A4-20C20-104	●	20	20	4	20	104	Cylindrical

● : Line up

ECOMEISTER

TEB**A2**E

2 flute ball nose endmill, 30° helix angle, short type

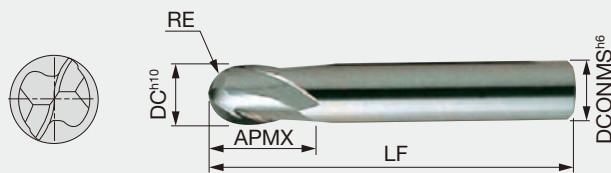

Designation	AH725	DC	DCONMS	NOF	RE	APMX	LF	Shank
TEB020A2-04C06-E48	●	2	6	2	1	4	48	Cylindrical
TEB020A2-06C03-E38	●	2	3	2	1	6	38	Cylindrical
TEB025A2-04C06-E48	●	2.5	6	2	1.25	4	48	Cylindrical
TEB030A2-04C06-E48	●	3	6	2	1.5	4	48	Cylindrical
TEB040A2-06C06-E50	●	4	6	2	2	6	50	Cylindrical
TEB040A2-08W06-E57	●	4	6	2	2	8	57	Weldon
TEB060A2-07C06-E51	●	6	6	2	3	7	51	Cylindrical
TEB060A2-10W06-E57	●	6	6	2	3	10	57	Weldon
TEB080A2-09C08-E63	●	8	8	2	4	9	63	Cylindrical
TEB100A2-10C10-E66	●	10	10	2	5	10	66	Cylindrical
TEB120A2-14C12-E71	●	12	12	2	6	14	71	Cylindrical
TEB200A2-20C20-E82	●	20	20	2	10	20	82	Cylindrical

● : Line up

Reference pages: Standard cutting conditions → [I053](#), Technical guide → [I054](#)

VARIABLEMEISTER SHREDMEISTER SOLIDMEISTER ECOMEISTER

STANDARD CUTTING CONDITIONS - Ball nose type

Shape machining (Roughing to semi-finishing)

ISO	Workpiece material	Hardness	Vc (m/min)	fz (mm/t)			ap
				ø3 - ø6	ø8 - ø12	ø16 - ø20	
P	Carbon steel	- 300 HB	125 - 200	0.02 - 0.055	0.04 - 0.08	0.06 - 0.11	0.05 - 0.12xD
	Alloy steel	- 300 HB	100 - 150	0.01 - 0.035	0.03 - 0.05	0.045 - 0.06	0.04 - 0.1xD
M	Stainless steel	- 200 HB	110	0.015 - 0.03	0.03 - 0.04	0.05 - 0.06	0.05 - 0.1xD
K	Cast iron	150 - 250 HB	150 - 180	0.03 - 0.06	0.06 - 0.09	0.09 - 0.12	0.08 - 0.15xD
H	Hardened steel	- 49 HRC	70 - 80	0.008 - 0.02	0.025 - 0.03	0.03 - 0.04	0.04 - 0.08xD
	Hardened steel	50 - 60 HRC	30 - 40	0.005 - 0.008	0.007 - 0.013	0.009 - 0.02	0.03 - 0.06xD

Finishing

ISO	Workpiece material	Hardness	Vc (m/min)	fz (mm/t)			ap
				ø3 - ø6	ø8 - ø12	ø16 - ø20	
P	Carbon steel	- 300 HB	170 - 280	0.017 - 0.046	0.034 - 0.068	0.051 - 0.094	0.02xD
	Alloy steel	- 300 HB	120 - 165	0.008 - 0.03	0.025 - 0.043	0.038 - 0.051	0.01xD
M	Stainless steel	- 200 HB	150	0.012 - 0.026	0.025 - 0.034	0.042 - 0.051	0.01xD
K	Cast iron	150 - 250 HB	200 - 220	0.025 - 0.051	0.051 - 0.077	0.076 - 0.102	0.03xD
H	Hardened steel	- 49 HRC	100	0.007 - 0.017	0.021 - 0.026	0.025 - 0.034	0.01xD
	Hardened steel	50 - 60 HRC	40 - 50	0.004 - 0.007	0.006 - 0.011	0.007 - 0.017	0.01xD

- When using AH750, reducing cutting speed by 20 to 30% is effective for extending tool life.
- While air blow is recommended, water-soluble coolant will be good for stainless steel, titanium alloy, and heat-resistant alloy.
- When chattering occurs with low rigid machines or settings, reduce cutting speed and feed at an equal rate.
- When chattering occurs with long tool overhang, reduce cutting speed and feed by 20 to 40% (VariableMeister is recommended for such operations).

Grade
Insert
Ext. Toolholder
Int. Toolholder
Threading
Grooving
Miniature tool
Milling cutter
Endmill
Drilling tool
Tooling System
User's Guide
Index



TECHNICAL GUIDE - Ball nose type

Ball Nose Characteristics

- Die & mold making, turbine manufacturing and aircraft industry, etc.
- Useful for intricate-shaped surfaces.
- Profiling of up to 70 HRC high hardened steels and alloy steels, nickel based alloys, titanium alloys.
- Ultra-fine grain carbide which increases both toughness and hardness.
- Suitable for dry and high speed cutting.
- Special sphere shaped tool geometry provides increased tool life and enables higher speed and feed operations.

Milling Features

- Operating angle: max 212°
- Excellent surface roughness and high milling process.
- Enables milling with high speed and feed in back milling mode.

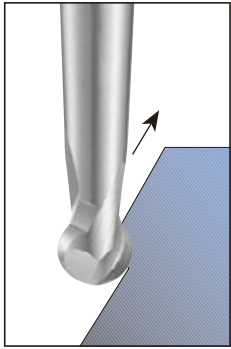

Favorable
Back Milling 

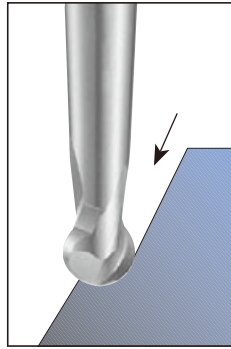

Unfavorable
Milling

Operating Recommendations

- It is recommended to machine with the tool inclined at a 15° angle. This technique eliminates cutting at nearly zero speed at the tool axis. Cutting is more efficient, and tool life substantially improves.
- Decreased cutting force.
- Excellent surface roughness and brightness.

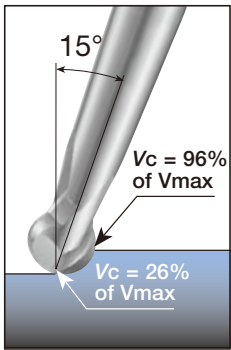

Favorable
Profiling 

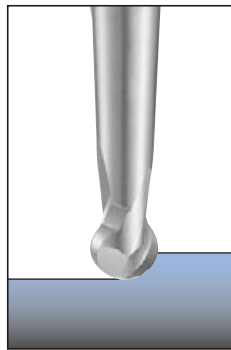

Unfavorable
Profiling

2

3

4

5

6
or more

P

M

K

N

S

H

4 flute high feed endmill

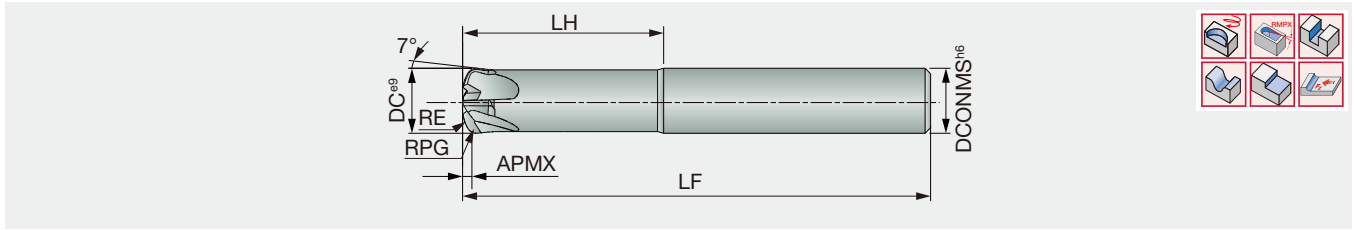

Designation	AH750	DC	DCONMS	NOF	RPG ⁽¹⁾	RE	APMX	LH	LF	Max. fz (mm/t)
TEFF060N4-030/20C06R10M	●	6	6	4	1.0	5.3	0.3	20	57	0.3
TEFF080N4-035/26C08R13M	●	8	8	4	1.3	7	0.4	26	63	0.4
TEFF100N4-040/30C10R16M	●	10	10	4	1.6	8.8	0.5	30	72	0.5
TEFF120N4-045/34C12R20M	●	12	12	4	2.0	10.6	0.6	34	83	0.5
TEFF160N4-055/42C16R26M	●	16	16	4	2.6	14	0.8	42	92	0.6
TEFF200N4-060/46C20R32M	●	20	20	4	3.2	17.7	1	46	104	0.7

(1) RPG should be used for programming.

● : Line up

TCFF**A3

3 flute high feed endmill

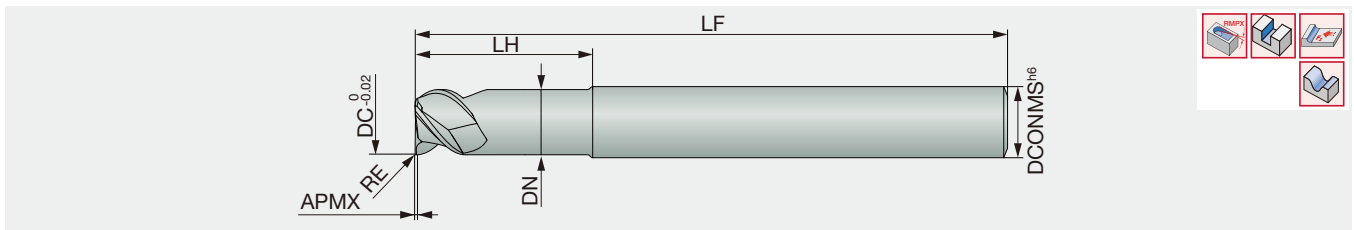

Designation	FX510	DC	DCONMS	NOF	DN	RE	APMX	LH	LF
TCFF060A3-06/15C6-50	●	6	6	3	5.5	0.42	0.25	15	50
TCFF080A3-08/20C8-57	●	8	8	3	7.5	0.56	0.4	20	57
TCFF100A3-08/25C10-65	●	10	10	3	9.5	0.7	0.5	25	65
TCFF120A3-10/30C12-72	●	12	12	3	11.5	1.1	0.6	30	72
TCFF160A3-12/35C16-83	●	16	16	3	15.5	1.9	0.75	35	83
TCFF200A3-15/40C20-93	●	20	20	3	19.5	2.5	1	40	93

Caution:

High speed machining generates heat in the tool and chuck holder. Thermal expansion of the holder will often lead to tool damage. Use an air coolant during machining to cool the tool holder. Milling chucks are recommended for the toolholder to be used.

*Use the above corner radius values (RE) for programming.

● : Line up

STANDARD CUTTING CONDITIONS

Shape machining (roughing) TEFF**N4...

ISO	Workpiece material	Hardness	Vc (m/min)	fz (mm/t)		
				ø6 - ø8	ø10 - ø12	ø16 - ø20
P	Carbon steel	- 300 HB	140 - 180	0.25 - 0.48	0.35 - 0.67	0.52 - 0.9
	Alloy steel	- 300 HB	120 - 130	0.2 - 0.28	0.3 - 0.38	0.43 - 0.57
M	Stainless steel	- 200 HB	120	0.25 - 0.3	0.35 - 0.43	0.52 - 0.6
K	Cast iron	150 - 250 HB	160 - 180	0.3 - 0.45	0.45 - 0.6	0.6 - 0.8
H	Hardened steel	- 49 HRC	100	0.16 - 0.2	0.25 - 0.33	0.4 - 0.48
	Hardened steel	50 - 60 HRC	60 - 80	0.1 - 0.16	0.16 - 0.3	0.2 - 0.45

- Please be aware that the maximum depth of cut (APMX) and the feed (fz) will depend on each tool diameter.
- While air blow is recommended, water-soluble coolant will be good for stainless steel, titanium alloy, and heat-resistant alloy.
- When chattering occurs with low rigid machines or settings, reduce cutting speed (Vc) and feed (fz) at an equal rate.
- When chattering occurs with long tool overhang, reduce cutting speed (Vc) and feed (fz) by 20 to 40%.

Shape machining (roughing) TCFF**A3...

ISO	Workpiece material	Hardness	Vc (m/min)	fz (mm/t)		
				ø6 - ø8	ø10 - ø12	ø16 - ø20
K	Cast iron	150 - 250 HB	250 - 1000	0.1 - 0.15	0.17 - 0.19	0.23 - 0.25
	Ductile cast iron	150 - 250 HB	250 - 1000	0.1 - 0.15	0.17 - 0.19	0.23 - 0.25
	Malleable cast iron	150 - 250 HB	250 - 1000	0.1 - 0.15	0.17 - 0.19	0.23 - 0.25
N	Non-ferrous metal / Graphite	-	500 - 1500	0.1 - 0.15	0.17 - 0.19	0.23 - 0.25
S	Nickel based alloy	-	250 - 1000	0.1 - 0.13	0.15 - 0.18	0.20 - 0.22

*Dry cutting at the cutting speed more than 250m/min is recommended for machining nickel based alloy.

SOLIDMEISTER**TETR**A2**R**

2 flute toroidal endmill

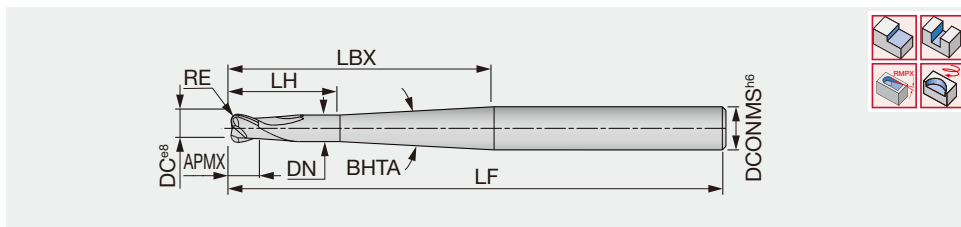

Designation	AH725	DC	DCONMS	NOF	DN	RE	APMX	LH	LBX	BHTA	LF	Shank
TETR020A2-2/08C06R05M80	●	2	6	2	1.9	0.5	2	8	40	3.6°	80	Cylindrical
TETR030A2-2/12C06R05M80	●	3	6	2	2.8	0.5	2	12	40	3.3°	80	Cylindrical
TETR040A2-3/16C06R1M80	●	4	6	2	3.7	1	3	16	40	2.8°	80	Cylindrical
TETR060A2-4/25C08R2M100	●	6	8	2	5.6	2	4	25	66	2.0°	100	Cylindrical

● : Line up

Reference pages: Standard cutting conditions → **I057**

Slotting / Roughing

ISO	Workpiece material	Hardness	Vc (m/min)	fz (mm/t)			
				ø2	ø3	ø4	ø6
P	Carbon steel	- 300 HB	140 - 180	0.01 - 0.03	0.01 - 0.04	0.02 - 0.05	0.03 - 0.07
	Alloy steel	- 300 HB	70 - 150	0.01 - 0.03	0.01 - 0.04	0.02 - 0.05	0.03 - 0.07
M	Stainless steel	- 200 HB	60 - 100	0.01 - 0.03	0.01 - 0.04	0.02 - 0.05	0.03 - 0.07
K	Cast iron	150 - 250 HB	80 - 180	0.01 - 0.03	0.01 - 0.04	0.02 - 0.05	0.03 - 0.07
N	Aluminium alloy	-	300 - 750	0.01 - 0.03	0.01 - 0.04	0.02 - 0.05	0.03 - 0.07
S	Titanium alloy	-	20 - 50	0.01 - 0.03	0.01 - 0.04	0.02 - 0.05	0.03 - 0.07
H	Hardened steel	- 60 HRC	20 - 30	0.01 - 0.03	0.01 - 0.04	0.02 - 0.05	0.03 - 0.07

Semi-finishing / Shouldering (ae = 0.1-0.4 x D)

ISO	Workpiece material	Hardness	Vc (m/min)	fz (mm/t)			
				ø2	ø3	ø4	ø6
P	Carbon steel	- 300 HB	150 - 220	0.01 - 0.03	0.01 - 0.04	0.02 - 0.05	0.03 - 0.07
	Alloy steel	- 300 HB	70 - 160	0.01 - 0.03	0.01 - 0.04	0.02 - 0.05	0.03 - 0.07
M	Stainless steel	- 200 HB	80 - 130	0.01 - 0.03	0.01 - 0.04	0.02 - 0.05	0.03 - 0.07
K	Cast iron	150 - 250 HB	130 - 220	0.01 - 0.03	0.01 - 0.04	0.02 - 0.05	0.03 - 0.07
N	Aluminium alloy	-	350 - 850	0.01 - 0.03	0.01 - 0.04	0.02 - 0.05	0.03 - 0.07
S	Titanium alloy	-	40 - 60	0.01 - 0.03	0.01 - 0.04	0.02 - 0.05	0.03 - 0.07
H	Hardened steel	- 60 HRC	30 - 70	0.01 - 0.03	0.01 - 0.04	0.02 - 0.05	0.03 - 0.07

Finishing (feed rate depending on required accuracy) / High feed machining at low depth of cut (ae = 0.05-0.1 x D)

ISO	Workpiece material	Hardness	Vc (m/min)	fz (mm/t)			
				ø2	ø3	ø4	ø6
P	Carbon steel	- 300 HB	170 - 280	0.01 - 0.03	0.01 - 0.04	0.02 - 0.05	0.03 - 0.07
	Alloy steel	- 300 HB	110 - 220	0.01 - 0.03	0.01 - 0.04	0.02 - 0.05	0.03 - 0.07
M	Stainless steel	- 200 HB	100 - 160	0.01 - 0.03	0.01 - 0.04	0.02 - 0.05	0.03 - 0.07
K	Cast iron	150 - 250 HB	180 - 280	0.01 - 0.03	0.01 - 0.04	0.02 - 0.05	0.03 - 0.07
N	Aluminium alloy	-	350 - 900	0.01 - 0.03	0.01 - 0.04	0.02 - 0.05	0.03 - 0.07
S	Titanium alloy	-	50 - 70	0.01 - 0.03	0.01 - 0.04	0.02 - 0.05	0.03 - 0.07
H	Hardened steel	- 60 HRC	40 - 80	0.01 - 0.03	0.01 - 0.04	0.02 - 0.05	0.03 - 0.07

- When the depth of cut (ae) is closer to the upper limit, please start with a lower limit value of cutting speed (Vc).
- The items with long slot (2xD or over) is not suitable for slotting operation.
- While air blow is recommended, water-soluble coolant will be good for stainless steel, titanium alloy, and heat-resistant alloy.
- When chattering occurs with low rigid machines or settings, reduce cutting speed and feed at an equal rate.
- When chattering occurs with long tool overhang, reduce cutting speed and feed by 20 to 40%.
- In slotting of high hardened steel, heat-resistant alloy, and some types of stainless steel, start with $ap=0.2xD$ and increase the value gradually while checking the status of the operation.
- In shoulder milling of high hardened steel and heat-resistant alloy, the cutting width should be started at $ae=0.05xD$ and increase the value gradually while checking the status of the operation.
- Low feed in finishing is recommended for good surface roughness.



DEB1000

T-DIA endmill for high speed aluminium machining

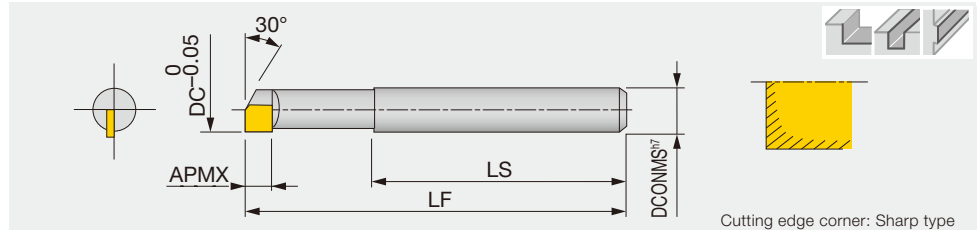

Designation	DX140	DC	DCONMS	NOF	APMX	LS	LF
DEB1040	●	4	6	1	3.5	32	45
DEB1050	●	5	6	1	3.5	35	50
DEB1060	●	6	6	1	3.5	35	50
DEB1080	●	8	8	1	5	37	55
DEB1100	●	10	10	1	5	40	60
DEB1120	●	12	12	1	5	45	65

- The cutting edge is very sharp. Please handle it carefully. Do not directly measure the cutting edge with micrometer, etc. as it may cause chipping.
- Please keep the tool overhang from the milling chuck as short as possible.
- Please choose a machine that is as rigid as possible.

● : Line up

STANDARD CUTTING CONDITIONS**DEB1000**For side milling $a_p \leq 3D$, $a_e = 0.1 \text{ mm}$

ISO	Workpiece material	Mill dia. (mm)	Cutting Speed V_c (m/min)	No. of revolutions n (min^{-1})	Table feed V_f (mm/min)
N	Aluminium alloys, Copper alloys	$\varnothing 4$	120 - 180	12,000	120
		$\varnothing 5$	120 - 180	9,600	120
		$\varnothing 6$	120 - 180	8,000	120
		$\varnothing 8$	120 - 180	6,000	120
		$\varnothing 10$	120 - 180	4,800	120
		$\varnothing 12$	120 - 180	4,000	100

- Keep the tool overhang as short as possible. When the overhang is long, please reduce the number of revolutions and feed to prevent chattering.
- Please adjust the number of revolutions and feed speed according to the cutting condition, such as depth of cut and machine rigidity.

BBB2000

T-CBN ball nose endmill for dies and molds

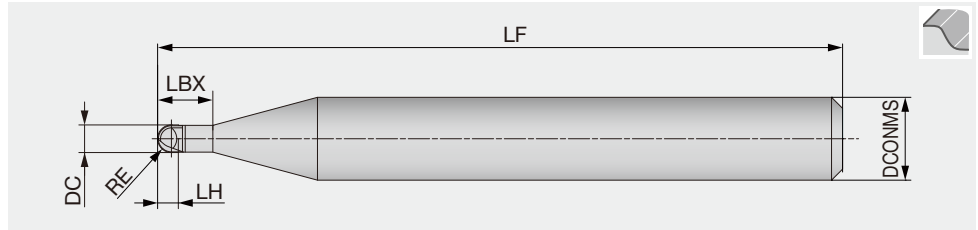

Designation	BX850	DC	DCONMS	NOF	RE	LH	LBX	LF
BBB2006	●	0.6	6	2	0.3	0.5	1.2	50
BBB2008	●	0.8	6	2	0.4	0.6	1.6	50
BBB2010	●	1	6	2	0.5	0.7	2	50
BBB2020	●	2	6	2	1	1.5	4	50

● : Line up

Tolerance (BBB2000)

R	R Tolerance	Tolerance on shank
0.3 ~ 1	±0.005	h6

STANDARD CUTTING CONDITIONS

ISO	Workpiece material	Hardness	No. of revolutions n (min ⁻¹)	Ball radius (RE)							
				0.3		0.4		0.5		1	
				Depth of cut APMX × pf (mm)	Feed rate (mm/min)	Depth of cut APMX × pf (mm)	Feed rate (mm/min)	Depth of cut APMX × pf (mm)	Feed rate (mm/min)	Depth of cut APMX × pf (mm)	Feed rate (mm/min)
H	Prehardened steel (NAK80, etc.) Die steel (JIS SKD61, etc.)	~ 52 HRC	50,000	0.02 × 0.03	2,000	0.03 × 0.05	2,000	0.05 × 0.05	3,000	0.10 × 0.10	5,000
	Die steel (JIS SKD11, DRM1 & 2, etc.)	~ 62 HRC	50,000	0.01 × 0.02	2,000	0.02 × 0.03	2,000	0.03 × 0.05	3,000	0.05 × 0.05	5,000
	High speed steel, Die steel (JIS SKH, DRM3, etc.)	~ 70 HRC	50,000	0.01 × 0.02	1,500	0.01 × 0.03	1,500	0.02 × 0.03	2,000	0.03 × 0.05	3,000

- Depths of cut (APMX) shown in the table are the allowable maximum values.
- Mist cooling or air blow is recommended.
- The maximum number of revolutions of the machine to be used is lower than 50,000 min⁻¹, the revolutions and feed rate should be modified at same rate.
- Use smallest possible overhang.

Ball radius (RE)	Inclined angle of workpiece (θ_1) / Effective neck length (Z)			
0.3	0°30'/1.25	1°/1.30	2°/1.35	3°/1.45
0.4	0°30'/1.65	1°/1.70	2°/1.80	3°/1.90
0.5	0°30'/2.05	1°/2.10	2°/2.25	3°/2.40
1	0°30'/4.15	1°/4.25	2°/4.50	3°/4.80

Optimal tool combination for maximum productivity

Significantly reduced tool indexing time improves machining efficiency

1 Wide range of geometries

45 kinds of geometries are available. The head indexing is easy and highly accurate with the precision thread.

2 Three kinds of shank material

Users can choose the most suitable combination according to the machining parameters, length and application required.

Steel: For general purpose

Carbide: For highly accurate machining due to excellent rigidity

Tungsten: Reduced chattering due to high vibration damping capacity



Straight shank & neck



Straight shank & taper neck



Straight shank & neck (carbide)



Straight (for slotting)



High rigidity shank



ER collet



Adaptor for TungFlex

No setup time

Machine downtime is decreased considerably. Simplified setup since only the head is indexed.

Increases productivity by 90%

Exchange time / Piece

TUNGMEISTER

less than 1 minute

Solid endmill

10 minutes

High accuracy and repeatability

Repeatability and accuracy are maintained due to full contact of both taper and face.

Head exchange accuracy

Height: $\pm 20 \mu\text{m}$

Run out: $\leq 20 \mu\text{m}$

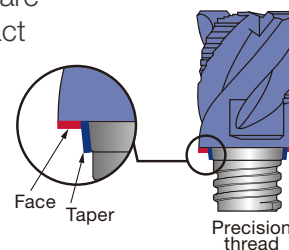



VEH, VEE, VED

Extensive tool diameter range from 5 to 32 mm

Covers a broad range of applications from precision machining to large size parts.



VMT

Thread milling heads

With multiple teeth for ISO, Unified, and Whitworth threads



VTR

Thread milling heads

With single tooth for ISO and Whitworth threads

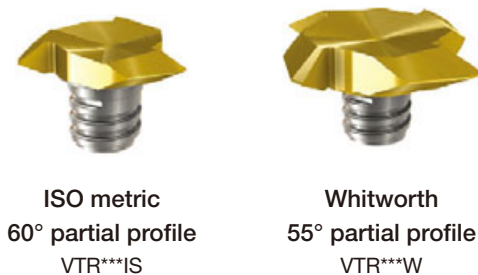

Grade
Insert
Ext. Toolholder
Int. Toolholder
Threading
Grooving
Miniature tool
Milling cutter
Endmill
Drilling tool
Tooling System
User's Guide
Index



Quick Guide **TUNGMEISTER**









Square, Face mill, High feed

★ : First choice ☆ : Second choice

Head geometry	Designation	Appearance	Application			Tool dia. (mm)	No. of cutting edges	Cutting edge length		Corner geometry	Helix angle	Pitch	CRKS	Workpiece material					Remarks	Page	
			Roughing	Semifinishing	Finishing			L/D	APMX (mm)					P	M	K	N	S			H
	VEH...		✓	✓	✓	ø8 - ø20	4	0.6 - 0.8XD	5 - 15	R	Variable	Variable	S05 - S12	★	★	★	☆	★	☆		1066
	VEH...		✓	✓	✓	ø8 - ø32	4	1.2 - 1.5XD	12 - 38	R	Variable	Variable	S05 - S21	★	★	★	☆	★	☆	Long edge	1066
	VEE**-04... VED**-04...		✓	✓	✓	ø5 - ø20	4	0.8XD	4 - 15	R	30/45	Regular	S04 - S12	★	★	★	☆	★	☆	General	1067
	VEE**I...		✓	✓	✓	ø8 - ø25	4	0.6 - 0.8XD	5 - 22	R/ Chamfered	38	Variable	S05 - S15	★	★	★	☆	★	☆		1068
	VEE**-03...		✓	✓	✓	ø7.7 - ø19.7	3	0.5XD	4 - 12	Sharp edge	38/45	Regular	S05 - S12	★	★	★	☆	★	☆	For key way	1068
	VEE**A02...		✓	✓	✓	ø10 - ø12	2	0.7XD	7 - 9	R	45	Regular	S06 - S08			☆	★				1069
 Square	VEE**A03...		✓	✓	✓	ø8 - ø20	3	0.6XD	5 - 12	R	45	Regular	S05 - S12			☆	★				1069
	VEE**R...		✓			ø8 - ø25	4, 5, 6	0.6 - 0.8XD	5 - 22	Chamfered	45	Regular	S05 - S15	★	★	★	☆	★	☆	Serrated cutting edge	1070
	VED**R...		✓			ø8 - ø25	4, 5, 6	1.5XD	12 - 37	Chamfered	47	Regular	S05 - S15	★	★	★	☆	★	☆	Serrated cutting edge/ Long edge	1070
	VEE**C...		✓	✓		ø8 - ø25	4	0.6 - 0.8XD	5 - 22	Chamfered	45	Regular	S05 - S15	★	★	★	☆	★	☆	Rough/ Finish combination geometry	1071
	VED**-06... VEE**-06...		✓	✓	✓	ø8 - ø12	6	0.6 - 0.8XD	5 - 9	R/ Chamfered	30/45/ 50	Regular	S05 - S08	☆	☆	☆		★	★	Small width of cut	1071
	VED**-08/10... VEE**-08/10...		✓	✓	✓	ø16 - ø25	8, 10	0.8XD	12 - 22	R/ Chamfered	30/50	Regular	S10 - S15	☆	☆	☆		★	★	Small width of cut	1072
	VED**-07/09...		✓	✓	✓	ø8 - ø25	7, 9	1.5XD	12 - 37	R	Variable	Variable	S05 - S15	☆	☆	☆		★	★	Small width of cut/Long edge	1072
 Face mill	VFM...		✓	✓	✓	ø12 - ø25	6	0.3XD	3.6 - 7.5	R	-	Variable	S05 - S10	★	★	★	☆	★	☆		1075
	VFX**-02...		✓			ø10 - ø20	2	0.06XD	0.6 - 1.5	-	-	Regular	S06 - S12	★	★	★	☆	★	★		1076
 High feed	VFX**-04/06...		✓			ø12, ø16	4, 6	0.05XD	0.6 - 1.05	-	-	Regular	S08 - S10	★	★	★	☆	★	★	With coolant hole	1076











Profiling (ball, radius, barrel)

★ : First choice ☆ : Second choice

Head geometry	Designation	Appearance	Application			Tool dia. (mm)	No. of cutting edges	Helix angle	Pitch	CRKS	Workpiece material						Remarks	Page	
			Roughing	Semifinishing	Finishing						P	M	K	N	S	H			
 Ball	VBB**-BM...		✓	✓		ø8 - ø16	2	0	Regular	S05 - S10	★	★	★	☆	★	★	Economical type	1078	
	VBB**-BG...				✓	ø8 - ø16	2	0	Regular	S05 - S10	★	★	★	☆	★	★	High accuracy h7	1078	
	VBD**-BG...			✓	✓		ø8 - ø16	2	30	Regular	S05 - S10	★	★	★	☆	★	★	Low cutting force	1078
	VBD**-BG-04... VBE**-BG-04...			✓	✓	✓	ø5 - ø25	4	30/38	Regular	S04 - S15	★	★	★	☆	★	★	Low cutting force	1079
	VBB**-SG...			✓	✓	✓	ø10 - ø20	2	0	Regular	S05 - S10	★	★	★	☆	★	★	High accuracy h7/ Sphere cutting edge	1079
	VBE**-BGA...			✓	✓	✓	ø8 - ø20	2	45	Regular	S05 - S12				☆	★			1079
 Radius	VRB**-02... VRC**-02...		✓	✓		ø10 - ø20	2	0/15	Regular	S06 - S12	★	★	★	☆	★	☆	Economical type	1081	
	VRD**-06...			✓	✓	ø8 - ø16	6	30	Regular	S05 - S10	★	★	★	☆	★	☆		1081	
	 Barrel	VBO...		✓	✓		ø8 - ø16	4, 5	30	Regular	S05 - S10	★	★	★	☆	★	☆	Profiling/ Long edge	1083
VBO...			✓	✓		ø10 - ø16	4	30	Regular	S06 - S10	★	★	★	☆	★	☆	Profiling/ Short edge	1083	
 Bull nose	VBN...		✓	✓		ø10 - ø16	6	35	Regular	S06 - S10	★	★	★	☆	★	☆	Profiling	1083	
 Lens	VBL...		✓	✓		ø8 - ø16	6	30	Regular	S05 - S10	★	★	★	☆	★	☆	Profiling	1084	







Quick Guide **TUNGMEISTER**

Multi-function (chamfering, spot drill, center hole, counterboring) ★ : First choice ☆ : Second choice

Head geometry	Designation	Appearance	Center edge (Z-feed capability)	Tool dia. (mm)	No. of cutting edges	Chamfering angle	Helix angle	Pitch	CRKS	Workpiece material						Remarks	Page
										P	M	K	N	S	H		
 Chamfering	VCA**-04/06...		Without	ø10 - ø20	4, 6	45	0	Regular	S06 - S12	★	★	★	☆	★	☆		1086
	VCW**-02...		Without	ø11.8	2	45	0	Regular	S06	★	★	★	☆	★	☆	Back chamfering capability	1086
	VCR**-02...		Without	ø8 - ø20	2	R	0	Regular	S05 - S12	★	★	★	☆	★	☆		1086
 Chamfering Spot drill	VCP**-02...		With	ø8 - ø16.5	2	30/45/60	0	Regular	S05 - S10	★	★	★	☆	★	☆		1088
	VDS...		With	ø8 - ø16	2	45	10	Regular	S05 - S10	★	★	★	☆	★	☆	Low cutting force	1088
 Center hole	VDP**-02...		With	ø1.07 - ø6.46	2	-	0	Regular	S04 - S12	★	★	★	☆	★	☆	For center hole	1090
 Counterboring	VGC**-02...		With	ø7.8 - ø16	2	-	10	Regular	S05 - S10	★	★	★	☆	★	☆	For counterboring	1091







Slotting

★ : First choice ☆ : Second choice







Head geometry	Designation	Appearance	Groove width (mm)	Tool dia. (mm)	No. of cutting edges	Edge shape	Helix angle	Pitch	CRKS	Workpiece material						Remarks	Page
										P	M	K	N	S	H		
 Slotting	VST**-3...		1.2 - 3.17	ø15.7 - ø17.7	3	R	0	Regular	S06	★	★	★	☆	★	☆		1092
	VST**-4/6...		0.76 - 10	ø21.7 - ø27.7	4, 6	R	0	Regular	S08, S10	★	★	★	☆	☆	☆		1093
	VST**A45...		3.4 - 5.5	ø17.7 - ø21.7	3, 4	Chamfered	0	Regular	S06, S08	★	★	★	☆	★	☆	For chamfering, 45° chamfer angle	1093
	VTB**-06...		2 - 8	ø13.5 - ø25	6	R	0	Regular	S05 - S10	★	★	★	☆	★	☆		1094
	VTB**C15-06...		2	ø13.5	6	Chamfered	0	Regular	S05	★	★	★	☆	★	☆	With 45° chamfer	1094

Threading

★ : First choice ☆ : Second choice

Head geometry	Designation	Appearance	Feature	Wiper edge	No. of cutting edges	Tool dia. (mm)	Internal/ External	Thread type	Min. thread size	CRKS	Workpiece material						Page
											P	M	K	N	S	H	
 Threading	VMT***IS		Full profile	With	3 - 6	ø10 - ø16	Internal	ISO metric	M12X0.75	S05 - S08	★	★	★	☆	★	☆	I096
	VMT***UN		Full profile	With	3, 4, 5	ø10 - ø16	Internal	Unified	9/16-24 UNEF	S05 - S08	★	★	★	☆	★	☆	I096
	VMT***W		Full profile	With	4	ø10, 16	Internal/ External	Whitworth	G1/4	S05, S08	★	★	★	☆	★	☆	I097
	VTR***IS		Partial profile	Without	3, 4	ø15.7 - ø21.7	Internal/ External	60° partial profile	M20X0.5	S06, S08	★	★	★	☆	★	☆	I097
	VTR***W		Partial profile	Without	4	ø21.7	Internal/ External	55° partial profile	G3/4	S08	★	★	★	☆	★	☆	I097

Shank

Shank	Neck	Appearance	Material				Page
			Steel	Carbide	Carbide (with coolant hole)	Tungsten (with coolant hole)	
Straight	Straight		✓	✓	✓	✓	I100, I101
Weldon	Straight		✓	-	-	-	I102
Straight	Taper		✓	✓	-	✓	I102, I103
High rigidity shank			✓	✓	-	-	I100
Straight (slotting)			✓	✓	✓	-	I103
Adaptor for TungFlex			✓	-	-	-	I104
ER collet			✓	-	-	-	I104

4 flute, roughing - finishing, variable helix and pitch



Square

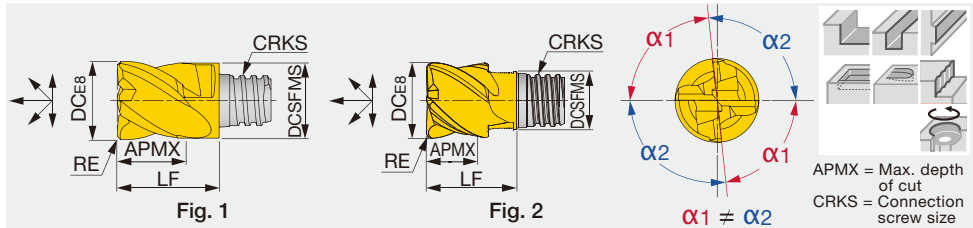

Designation	AH715	AH725	NOF	FHA	DC	DCSFMS	APMX	RE	CRKS	LF	Wrench	Torque*	Fig.
VEH080L05.0R05I04S05	●		4	41° - 45°	8	7.7	5	0.5	S05	10	KEYV-S05	7	1
VEH080L05.0R10I04S05		●	4	41° - 45°	8	7.7	5	1	S05	10	KEYV-S05	7	1
VEH100L07.0R10I04S05	●		4	41° - 45°	10	7.7	7	1	S05	12.8	KEYV-S05	7	2
VEH100L07.0R05I04S06		●	4	41° - 45°	10	9.7	7	0.5	S06	13	KEYV-S06	10	1
VEH100L07.0R10I04S06		●	4	41° - 45°	10	9.7	7	1	S06	13	KEYV-S06	10	1
VEH120L09.0R10I04S06	●		4	41° - 45°	12	9.3	9	1	S06	14.3	KEYV-S06	10	2
VEH120L09.0R05I04S08		●	4	41° - 45°	12	11.7	9	0.5	S08	16.5	KEYV-S08	15	1
VEH120L09.0R10I04S08		●	4	41° - 45°	12	11.7	9	1	S08	16.5	KEYV-S08	15	1
VEH160L12.0R10I04S08	●		4	41° - 45°	16	11.7	12	1	S08	20	KEYV-S08	15	2
VEH160L12.0R05I04S10		●	4	41° - 45°	16	15.3	12	0.5	S10	20.5	KEYV-S10	28	1
VEH160L12.0R10I04S10		●	4	41° - 45°	16	15.3	12	1	S10	20.5	KEYV-S10	28	1
VEH200L15.0R05I04S12		●	4	41° - 45°	20	18.3	15	0.5	S12	25.5	KEYV-S12	28	1
VEH200L15.0R10I04S12		●	4	41° - 45°	20	18.3	15	1	S12	25.5	KEYV-S12	28	1

Torque*: Recommended clamping torque (N-m)
2 pieces per package

● : Line up

VEH...

4 flute, roughing - finishing, long edge, variable helix and pitch



Square

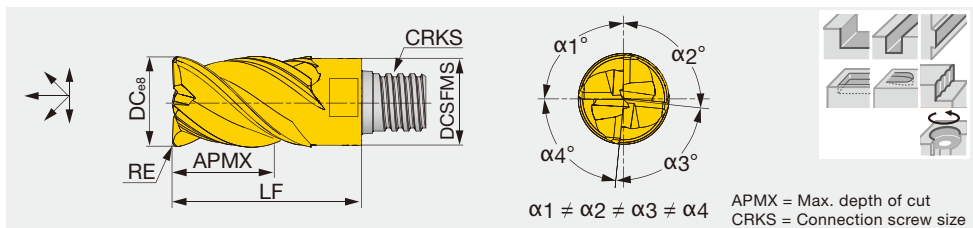

Designation	AH715	NOF	FHA	DC	DCSFMS	APMX	RE	CRKS	LF	Wrench	Torque*
VEH080L12.0R05I04S05	●	4	41° - 45°	8	7.7	12	0.5	S05	18	KEYV-S05	7
VEH080L12.0R10I04S05	●	4	41° - 45°	8	7.7	12	1	S05	18	KEYV-S05	7
VEH100L15.0R05I04S06	●	4	41° - 45°	10	9.7	15	0.5	S06	22	KEYV-S06	10
VEH100L15.0R10I04S06	●	4	41° - 45°	10	9.7	15	1	S06	22	KEYV-S06	10
VEH120L18.0R05I04S08	●	4	41° - 45°	12	11.7	18	0.5	S08	27	KEYV-S08	15
VEH120L18.0R10I04S08	●	4	41° - 45°	12	11.7	18	1	S08	27	KEYV-S08	15
VEH160L24.0R05I04S10	●	4	41° - 45°	16	15.3	24	0.5	S10	33.5	KEYV-S10	28
VEH160L24.0R10I04S10	●	4	41° - 45°	16	15.3	24	1	S10	33.5	KEYV-S10	28
VEH200L30.0R05I04S12	●	4	41° - 45°	20	18.45	30	0.5	S12	41	KEYV-S12	28
VEH200L30.0R10I04S12	●	4	41° - 45°	20	18.45	30	1	S12	41	KEYV-S12	28
VEH250L37.0R05I04S15	●	4	41° - 45°	25	23.9	37	0.5	S15	52.5	KEYV-W20	40
VEH250L37.0R10I04S15	●	4	41° - 45°	25	23.9	37	1	S15	52.5	KEYV-W20	40
VEH320L38.0R00I04S21	●	4	41° - 45°	32	30	38	-	S21	55	KS-24	110
VEH320L38.0R10I04S21	●	4	41° - 45°	32	30	38	1	S21	55	KS-24	110

Torque*: Recommended clamping torque (N-m)
VEH080 ~ VEH160: 2 pieces per package
VEH200 ~ VEH320: 1 piece per package

● : Line up

Reference pages: Standard cutting conditions → I073 - I074

VEE**-04..., VED**-04...

4 flute, roughing - finishing, general

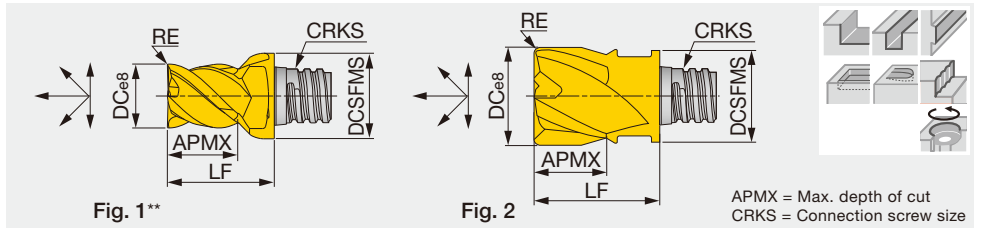

Designation	AH715	AH725	NOF	FHA	DC	DCSFMS	APMX	RE	CRKS	LF	Wrench	Torque*	Fig.
VEE050L04.0R05-04S04	●		4	45°	5	6	4	0.5	S04	8.5	KEYV-S05	4	1
VEE060L04.0R05-04S04		●	4	45°	6	5.8	4	0.5	S04	8.5	KEYV-S05	4	2
VEE060L05.0R00-04S05	●	●	4	45°	6	8	5	-	S05	10	KEYV-S05	7	1
VEE080L05.0R00-04S05		●	4	45°	8	7.7	5	-	S05	10	KEYV-S05	7	2
VED080L05.0R05-04S05		●	4	30°	8	7.7	5	0.5	S05	10	KEYV-S05	7	2
VED080L05.0R10-04S05		●	4	30°	8	7.7	5	1	S05	10	KEYV-S05	7	2
VED080L05.0R15-04S05		●	4	30°	8	7.7	5	1.5	S05	10	KEYV-S05	7	2
VEE100L07.0R00-04S06		●	4	45°	10	9.7	7	-	S06	13	KEYV-S06	10	2
VED100L07.0R05-04S06		●	4	30°	10	9.7	7	0.5	S06	13	KEYV-S06	10	2
VEE100L07.0R05-04S06		●	4	45°	10	9.7	7	0.5	S06	13	KEYV-S06	10	2
VED100L07.0R10-04S06		●	4	30°	10	9.7	7	1	S06	13	KEYV-S06	10	2
VEE100L07.0R10-04S06		●	4	45°	10	9.7	7	1	S06	13	KEYV-S06	10	2
VEE120L09.0R00-04S08	●	●	4	45°	12	11.7	9	-	S08	16.5	KEYV-S08	15	2
VED120L09.0R05-04S08		●	4	30°	12	11.7	9	0.5	S08	16.5	KEYV-S08	15	2
VEE120L09.0R05-04S08		●	4	45°	12	11.7	9	0.5	S08	16.5	KEYV-S08	15	2
VED120L09.0R10-04S08	●	●	4	30°	12	11.7	9	1	S08	16.5	KEYV-S08	15	2
VEE120L09.0R10-04S08		●	4	45°	12	11.7	9	1	S08	16.5	KEYV-S08	15	2
VEE160L12.0R00-04S10	●	●	4	45°	16	15.3	12	-	S10	20.5	KEYV-S10	28	2
VED160L12.0R05-04S10	●	●	4	30°	16	15.3	12	0.5	S10	20.5	KEYV-S10	28	2
VEE160L12.0R05-04S10		●	4	45°	16	15.3	12	0.5	S10	20.5	KEYV-S10	28	2
VED160L12.0R10-04S10		●	4	30°	16	15.3	12	1	S10	20.5	KEYV-S10	28	2
VEE160L12.0R10-04S10		●	4	45°	16	15.3	12	1	S10	20.5	KEYV-S10	28	2
VED160L12.0R15-04S10		●	4	30°	16	15.3	12	1.5	S10	20.5	KEYV-S10	28	2
VEE160L12.0R15-04S10		●	4	45°	16	15.3	12	1.5	S10	20.5	KEYV-S10	28	2
VED160L12.0R20-04S10		●	4	30°	16	15.3	12	2	S10	20.5	KEYV-S10	28	2
VEE160L12.0R20-04S10		●	4	45°	16	15.3	12	2	S10	20.5	KEYV-S10	28	2
VED160L12.0R30-04S10		●	4	30°	16	15.3	12	3	S10	20.5	KEYV-S10	28	2
VEE160L12.0R30-04S10	●	●	4	45°	16	15.3	12	3	S10	20.5	KEYV-S10	28	2
VED160L12.0R40-04S10		●	4	30°	16	15.3	12	4	S10	20.5	KEYV-S10	28	2
VEE160L12.0R40-04S10		●	4	45°	16	15.3	12	4	S10	20.5	KEYV-S10	28	2
VEE200L15.0R00-04S12		●	4	45°	20	18.3	15	-	S12	25.5	KEYV-S12	28	2
VED200L15.0R05-04S12		●	4	30°	20	18.3	15	0.5	S12	25.5	KEYV-S12	28	2
VED200L15.0R10-04S12	●	●	4	30°	20	18.3	15	1	S12	25.5	KEYV-S12	28	2
VED200L15.0R20-04S12		●	4	30°	20	18.3	15	2	S12	25.5	KEYV-S12	28	2
VED200L15.0R30-04S12		●	4	30°	20	18.3	15	3	S12	25.5	KEYV-S12	28	2

Torque*: Recommended clamping torque (N·m)

**Fig. 1: Avoid interference with workpiece when using this cutting head. The shank diameter is larger than the cutter diameter when assembled.

2 pieces per package

● : Line up

4 flute, roughing - finishing, variable pitch



Square

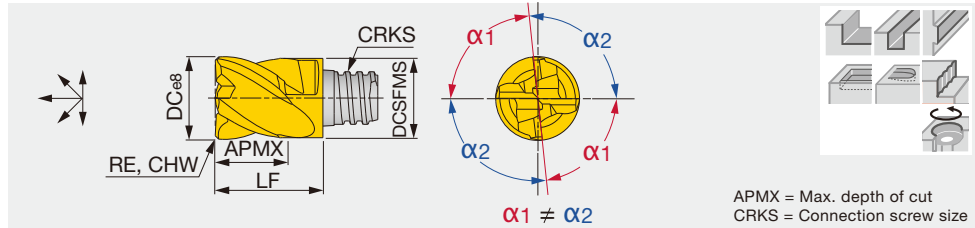

APMX = Max. depth of cut
CRKS = Connection screw size

Designation	AH715	AH725	NOF	FHA	DC	DCSFMS	APMX	RE	CHW	CRKS	LF	Wrench	Torque*
VEE080L05.0C30I04S05	●		4	38°	8	7.7	5	-	0.3	S05	10	KEYV-S05	7
VEE100L07.0C40I04S06	●		4	38°	10	9.7	7	-	0.4	S06	13	KEYV-S06	10
VEE120L09.0C50I04S08	●		4	38°	12	11.7	9	-	0.5	S08	16.5	KEYV-S08	15
VEE160L12.0C60I04S10	●	●	4	38°	16	15.3	12	-	0.6	S10	20.5	KEYV-S10	28
VEE200L15.0C60I04S12	●	●	4	38°	20	18.3	15	-	0.6	S12	25.5	KEYV-S12	28
VEE250L22.0C60I04S15	●	●	4	38°	25	23.9	22	-	0.6	S15	37	KEYV-W20	40
VEE250L22.0R00I04S15	●	●	4	38°	25	23.9	22	-	-	S15	37	KEYV-W20	40
VEE250L22.0R05I04S15	●	●	4	38°	25	23.9	22	0.5	-	S15	37	KEYV-W20	40
VEE250L22.0R10I04S15	●	●	4	38°	25	23.9	22	1	-	S15	37	KEYV-W20	40
VEE250L22.0R20I04S15	●	●	4	38°	25	23.9	22	2	-	S15	37	KEYV-W20	40
VEE250L22.0R30I04S15	●	●	4	38°	25	23.9	22	3	-	S15	37	KEYV-W20	40

Torque*: Recommended clamping torque (N-m)
VEE080 - VEE200: 2 pieces per package
VEE250: 1 piece per package

● : Line up



Square



Ball



Radius



Chamfering



Slotting



Threading



Others

VEE**-03...

3 flute, roughing - finishing, general, for key way



Square

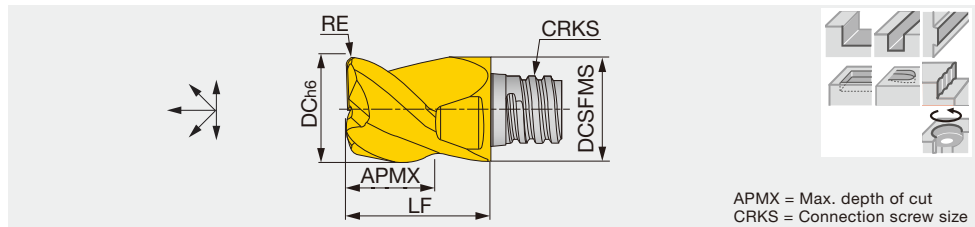

APMX = Max. depth of cut
CRKS = Connection screw size

Designation	AH715	AH725	NOF	FHA	DC	DCSFMS	APMX	RE	CRKS	LF	Wrench	Torque*
VEE077L04.0R02-03S05	●		3	38°	7.7	7.7	4	0.2	S05	10	KEYV-S05	7
VEE080L05.0R00-03S05	●		3	45°	8	7.7	5	-	S05	10	KEYV-S05	7
VEE097L05.0R03-03S06	●		3	38°	9.7	9.7	5	0.3	S06	13	KEYV-S06	10
VEE100L07.0R00-03S06	●	●	3	45°	10	9.7	7	-	S06	13	KEYV-S06	10
VEE117L07.0R03-03S08	●	●	3	38°	11.7	11.7	7	0.3	S08	16.5	KEYV-S08	15
VEE120L09.0R00-03S08	●	●	3	45°	12	11.7	9	-	S08	16.5	KEYV-S08	15
VEE157L08.0R03-03S10	●	●	3	38°	15.7	15.3	8	0.3	S10	20.5	KEYV-S10	28
VEE197L12.0R04-03S12	●	●	3	38°	19.7	18.3	12	0.4	S12	25.5	KEYV-S12	28

Torque*: Recommended clamping torque (N-m)
2 pieces per package

● : Line up

Reference pages: Standard cutting conditions → I073 - I074

VEE**A02...

2 flute, roughing - finishing, for non-ferrous metal, general

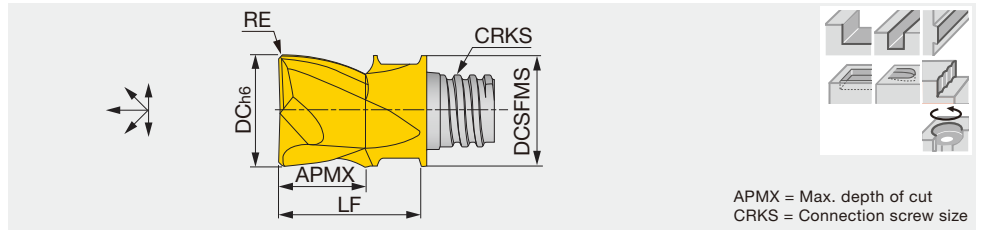

Designation	KS15F	NOF	FHA	DC	DCSFMS	APMX	RE	CRKS	LF	Wrench	Torque*
VEE100L07.0R05A02S06	●	2	45°	10	9.7	7	0.5	S06	13	KEYV-S06	10
VEE100L07.0R10A02S06	●	2	45°	10	9.7	7	1	S06	13	KEYV-S06	10
VEE120L09.0R05A02S08	●	2	45°	12	11.7	9	0.5	S08	16.5	KEYV-S08	15

Torque*: Recommended clamping torque (N-m)
2 pieces per package

● : Line up

VEE**A03...

3 flute, roughing - finishing, for non-ferrous metal, general

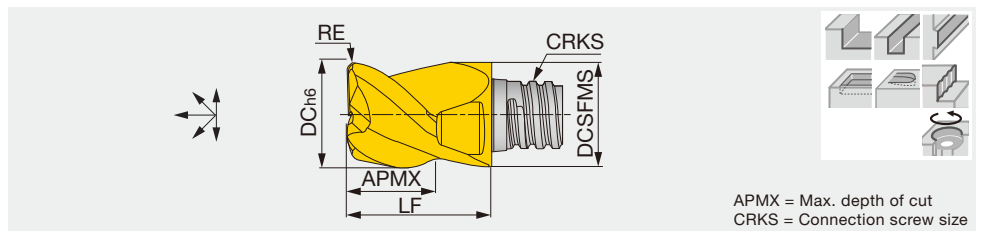

Designation	KS15F	NOF	FHA	DC	DCSFMS	APMX	RE	CRKS	LF	Wrench	Torque*
VEE080L05.0R05A03S05	●	3	45°	8	7.7	5	0.5	S05	10	KEYV-S05	7
VEE100L06.0R05A03S06	●	3	45°	10	9.7	6	0.5	S06	13	KEYV-S06	10
VEE100L06.0R10A03S06	●	3	45°	10	9.7	6	1	S06	13	KEYV-S06	10
VEE120L08.0R05A03S08	●	3	45°	12	11.7	8	0.5	S08	16.5	KEYV-S08	15
VEE120L08.0R10A03S08	●	3	45°	12	11.7	8	1	S08	16.5	KEYV-S08	15
VEE160L10.0R00A03S10	●	3	45°	16	15.3	10	-	S10	20.5	KEYV-S10	28
VEE160L10.0R10A03S10	●	3	45°	16	15.3	10	1	S10	20.5	KEYV-S10	28
VEE160L10.0R20A03S10	●	3	45°	16	15.3	10	2	S10	20.5	KEYV-S10	28
VEE200L12.0R05A03S12	●	3	45°	20	18.3	12	0.5	S12	25.5	KEYV-S12	28
VEE200L12.0R10A03S12	●	3	45°	20	18.3	12	1	S12	25.5	KEYV-S12	28
VEE200L12.0R20A03S12	●	3	45°	20	18.3	12	2	S12	25.5	KEYV-S12	28

Torque*: Recommended clamping torque (N-m)
2 pieces per package

● : Line up

4, 5, 6 flute, roughing, serrated cutting edge

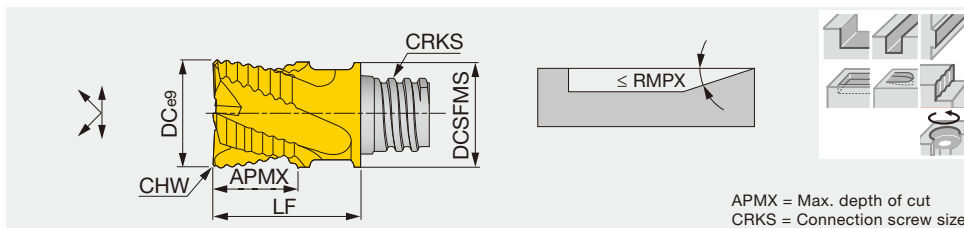

Square

APMX = Max. depth of cut
CRKS = Connection screw size

Designation	AH715	AH725	NOF	FHA	DC	DCSFMS	APMX	CHW	CRKS	LF	RMPX	Wrench	Torque*
VEE080L05.0C25R04S05	●	●	4	45°	8	7.7	5	0.25	S05	10	5°	KEYV-S05	7
VEE100L07.0C30R04S06	●	●	4	45°	10	9.7	7	0.3	S06	13	5°	KEYV-S06	10
VEE120L09.0C35R04S08	●	●	4	45°	12	11.7	9	0.35	S08	16.5	5°	KEYV-S08	15
VEE160L12.0C40R05S10	●	●	5	45°	16	15.3	12	0.4	S10	20.5	5°	KEYV-S10	28
VEE200L15.0C40R06S12	●	●	6	45°	20	18.3	15	0.4	S12	25.5	3°	KEYV-S12	28
VEE250L22.0C50R06S15	●	●	6	45°	25	23.9	22	0.5	S15	37	3°	KEYV-W20	40

Torque*: Recommended clamping torque (N-m)

VEE080 - VEE200: 2 pieces per package

VEE250: 1 piece per package

● : Line up



Square



Ball



Radius



Chamfering



Slotting



Threading



Others

VED**R...

4, 5, 6 flute, roughing, long cutting edge, serrated cutting edge

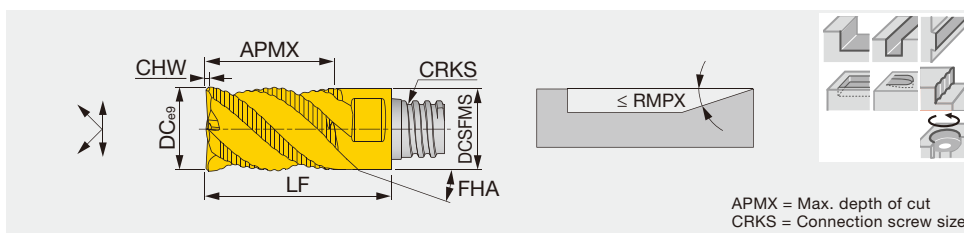

Square

APMX = Max. depth of cut
CRKS = Connection screw size

Designation	AH725	NOF	FHA	DC	DCSFMS	APMX	CHW	CRKS	LF	RMPX	Wrench	Torque*
VED080L12.0C25R04S05	●	4	47°	8	7.7	12	0.25	S05	18	5°	KEYV-S05	7
VED100L15.0C30R04S06	●	4	47°	10	9.6	15	0.3	S06	22	5°	KEYV-S06	10
VED120L18.0C35R04S08	●	4	47°	12	11.7	18	0.35	S08	27	5°	KEYV-S08	15
VED160L24.0C40R05S10	●	5	47°	16	15.3	24	0.4	S10	33.5	5°	KEYV-S10	28
VED200L30.0C40R06S12	●	6	47°	20	18.45	30	0.4	S12	41	3°	KEYV-S12	28
VED250L37.0C50I06S15	●	6	47°	25	23.9	37	0.5	S15	52.5	3°	KEYV-W20	40

Torque*: Recommended clamping torque (N-m)

VED080 - VED160: 2 pieces per package

VED200, VED250: 1 piece per package

● : Line up

Reference pages: Standard cutting conditions → **I073 - I074**

VEE**C...

4 flute, roughing - semi finishing, roughing and finishing edge combination

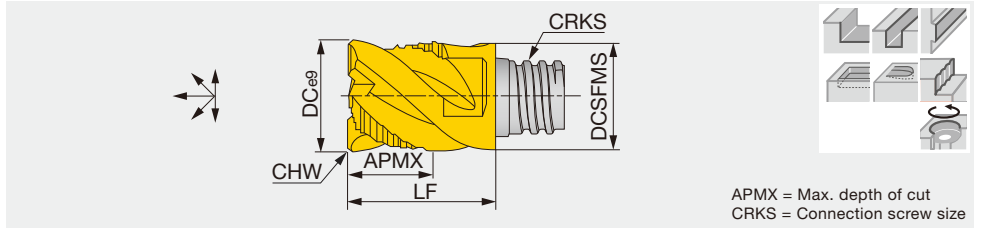

Designation	AH725	NOF	FHA	DC	DCSFMS	APMX	CHW	CRKS	LF	Wrench	Torque*
VEE080L05.0C30C04S05	●	4	45°	8	7.7	5	0.3	S05	10	KEYV-S05	7
VEE100L07.0C30C04S06	●	4	45°	10	9.7	7	0.3	S06	13	KEYV-S06	10
VEE120L09.0C40C04S08	●	4	45°	12	11.7	9	0.4	S08	16.5	KEYV-S08	15
VEE160L12.0C60C04S10	●	4	45°	16	15.3	12	0.6	S10	20.5	KEYV-S10	28
VEE200L15.0C60C04S12	●	4	45°	20	18.3	15	0.6	S12	25.5	KEYV-S12	28
VEE250L22.0C60C04S15	●	4	45°	25	23.9	22	0.6	S15	37	KEYV-W20	40

Torque*: Recommended clamping torque (N-m)
VEE080 - VEE200: 2 pieces per package
VEE250: 1 piece per package

● : Line up

VED**-06..., VEE**-06...

6 flute, roughing - finishing, small width of cut

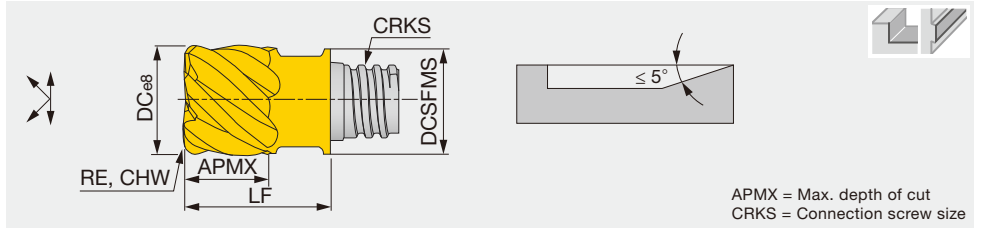

Designation	AH725	AH750	NOF	FHA	DC	DCSFMS	APMX	RE	CHW	CRKS	LF	Wrench	Torque*
VEE080L05.0R05-06S05	●		6	45°	8	7.7	5	0.5	-	S05	10	KEYV-S05	7
VEE080L05.0R10-06S05	●		6	45°	8	7.7	5	1	-	S05	10	KEYV-S05	7
VEE080L05.0R15-06S05	●		6	45°	8	7.7	5	1.5	-	S05	10	KEYV-S05	7
VEE080L05.0C10-06S05		●	6	50°	8	7.7	5	-	0.1	S05	10	KEYV-S05	7
VEE100L07.0R00-06S06	●		6	45°	10	9.7	7	-	-	S06	13	KEYV-S06	10
VED100L07.0R05-06S06	●		6	30°	10	9.7	7	0.5	-	S06	13	KEYV-S06	10
VEE100L07.0R05-06S06	●		6	45°	10	9.7	7	0.5	-	S06	13	KEYV-S06	10
VED100L07.0R10-06S06	●		6	30°	10	9.7	7	1	-	S06	13	KEYV-S06	10
VEE100L07.0R10-06S06	●		6	45°	10	9.7	7	1	-	S06	13	KEYV-S06	10
VED100L07.0R15-06S06	●		6	30°	10	9.7	7	1.5	-	S06	13	KEYV-S06	10
VEE100L07.0R15-06S06	●		6	45°	10	9.7	7	1.5	-	S06	13	KEYV-S06	10
VEE100L07.0C10-06S06		●	6	50°	10	9.7	7	-	0.1	S06	13	KEYV-S06	10
VEE120L09.0R00-06S08	●		6	45°	12	11.7	9	-	-	S08	16.5	KEYV-S08	15
VED120L09.0R05-06S08	●		6	30°	12	11.7	9	0.5	-	S08	16.5	KEYV-S08	15
VED120L09.0R10-06S08	●		6	30°	12	11.7	9	1	-	S08	16.5	KEYV-S08	15
VEE120L09.0R10-06S08	●		6	45°	12	11.7	9	1	-	S08	16.5	KEYV-S08	15
VEE120L09.0R15-06S08	●		6	45°	12	11.7	9	1.5	-	S08	16.5	KEYV-S08	15
VEE120L09.0C10-06S08		●	6	50°	12	11.7	9	-	0.1	S08	16.5	KEYV-S08	15

Torque*: Recommended clamping torque (N-m)
2 pieces per package

● : Line up

Reference pages: Standard cutting conditions → I073 - I074

8, 10 flute, roughing - finishing, small width of cut



Square

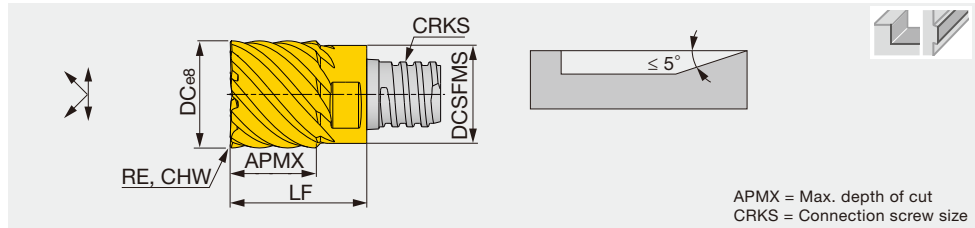

Designation	AH715	AH725	AH750	NOF	FHA	DC	DCSFMS	APMX	RE	CHW	CRKS	LF	Wrench	Torque*
VED160L12.0R05-08S10	●			8	30°	16	15.3	12	0.5	-	S10	20.5	KEYV-S10	28
VED160L12.0R10-08S10	●	●		8	30°	16	15.3	12	1	-	S10	20.5	KEYV-S10	28
VED160L12.0R16-08S10	●			8	30°	16	15.3	12	1.6	-	S10	20.5	KEYV-S10	28
VED160L12.0R20-08S10	●			8	30°	16	15.3	12	2	-	S10	20.5	KEYV-S10	28
VEE160L12.0C20-08S10			●	8	50°	16	15.3	12	-	0.2	S10	20.5	KEYV-S10	28
VED200L15.0R10-10S12	●			10	30°	20	18.3	15	1	-	S12	25.5	KEYV-S12	28
VED200L15.0R20-10S12	●			10	30°	20	18.3	15	2	-	S12	25.5	KEYV-S12	28
VEE200L15.0C20-10S12			●	10	50°	20	18.3	15	-	0.2	S12	25.5	KEYV-S12	28
VED250L22.0R10-10S15	●			10	30°	25	23.9	22	1	-	S15	37	KEYV-W20	40

Torque*: Recommended clamping torque (N-m)
VEE / VED160 - 200: 2 pieces per package
VED250: 1 piece per package

● : Line up



Square



Ball



Radius



Chamfering



Slotting



Threading



Others

VED-07/09...**

7, 9 flute, roughing - finishing, long edge, variable helix and pitch, small width of cut



Square

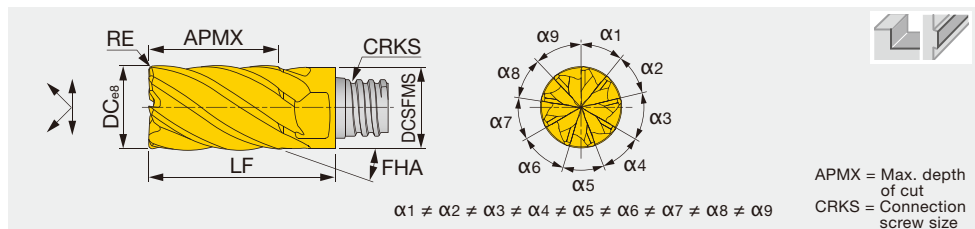

Designation	AH725	NOF	FHA	DC	DCSFMS	APMX	RE	CRKS	LF	Wrench	Torque*
VED080L12.0R05I07S05	●	7	34° - 40°	8	7.7	12	0.5	S05	18	KEYV-S05	7
VED100L15.0R05I07S06	●	7	34° - 40°	10	9.6	15	0.5	S06	22	KEYV-S06	10
VED120L18.0R05I07S08	●	7	34° - 40°	12	11.7	18	0.5	S08	27	KEYV-S08	15
VED160L24.0R08I09S10	●	9	34° - 40°	16	15.3	24	0.8	S10	33.5	KEYV-S10	28
VED200L30.0R10I09S12	●	9	34° - 40°	20	18.45	30	1	S12	41	KEYV-S12	28
VED250L37.0R10I09S15	●	9	34° - 40°	25	23.9	37	1	S15	52.5	KEYV-W20	40

Torque*: Recommended clamping torque (N-m)
VED080 - VED160: 2 pieces per package
VED200, VED250: 1 piece per package

● : Line up

Reference pages: Standard cutting conditions → **I073 - I074**

STANDARD CUTTING CONDITIONS

Shoulder milling

VEH, VEE: 3 flutes, VED / VEE: 4 flutes, VEE-A, VEE-I, VEE-R, VED-R, VEE-C

ISO	Workpiece material	Hardness	Cutting speed V_c (m/min)	Feed per tooth: f_z (mm/t)									Depth of cut a_p (mm)	Width of cut a_e (mm)
				Tool diameter: DC (mm)										
				5	6	8	10	12	16	20	25	32		
P	Carbon steel S45C, S55C, etc. C45, C55, etc.	- 300 HB	80 - 180	0.03 - 0.07	0.03 - 0.07	0.05 - 0.09	0.07 - 0.12	0.08 - 0.13	0.09 - 0.15	0.1 - 0.17	0.1 - 0.17	0.1 - 0.18	0.6 x DC	0.25 x DC
	Alloy steel SCM440, SCr420, etc. 42CrMo4, 20Cr4, etc.	- 300 HB	60 - 140	0.03 - 0.07	0.03 - 0.07	0.05 - 0.09	0.07 - 0.12	0.08 - 0.13	0.09 - 0.15	0.1 - 0.17	0.1 - 0.17	0.1 - 0.18	0.6 x DC	0.25 x DC
	Prehardened steel PX5, NAK80, etc.	30 - 40 HRC	60 - 120	0.03 - 0.07	0.03 - 0.07	0.05 - 0.09	0.07 - 0.12	0.08 - 0.13	0.09 - 0.15	0.1 - 0.17	0.1 - 0.17	0.1 - 0.18	0.6 x DC	0.25 x DC
M	Stainless steel SUS304, SUS316, etc. X5CrNi18-9, X5CrNiMo17-12-2, etc.	- 200 HB	40 - 100	0.03 - 0.07	0.03 - 0.07	0.05 - 0.09	0.07 - 0.12	0.08 - 0.13	0.09 - 0.15	0.1 - 0.17	0.1 - 0.17	0.1 - 0.18	0.6 x DC	0.25 x DC
K	Grey cast iron FC250, FC300, etc. 250, 300, etc., GG250, GG300, etc.	150 - 250 HB	80 - 200	0.03 - 0.07	0.03 - 0.07	0.05 - 0.09	0.07 - 0.12	0.08 - 0.13	0.09 - 0.15	0.1 - 0.17	0.1 - 0.17	0.1 - 0.18	0.6 x DC	0.25 x DC
	Ductile cast iron FCD450, etc. 450-10S, etc., GGG450, etc.	150 - 250 HB	80 - 200	0.03 - 0.07	0.03 - 0.07	0.05 - 0.09	0.07 - 0.12	0.08 - 0.13	0.09 - 0.15	0.1 - 0.17	0.1 - 0.17	0.1 - 0.18	0.6 x DC	0.25 x DC
N	Aluminium alloys Si < 13%	-	200 - 700	0.03 - 0.07	0.03 - 0.07	0.05 - 0.09	0.07 - 0.12	0.08 - 0.13	0.09 - 0.15	0.1 - 0.17	0.1 - 0.17	0.1 - 0.18	0.6 x DC	0.25 x DC
	Aluminium alloys Si ≥ 13%	-	100 - 300	0.03 - 0.07	0.03 - 0.07	0.05 - 0.09	0.07 - 0.12	0.08 - 0.13	0.09 - 0.15	0.1 - 0.17	0.1 - 0.17	0.1 - 0.18	0.6 x DC	0.25 x DC
S	Titanium alloys Ti-6Al-4V, etc.	- 40 HRC	40 - 80	0.03 - 0.07	0.03 - 0.07	0.05 - 0.09	0.07 - 0.12	0.08 - 0.13	0.09 - 0.15	0.1 - 0.17	0.1 - 0.17	0.1 - 0.18	0.6 x DC	0.25 x DC
	Heat-resistant alloys Inconel 718, etc.	- 40 HRC	20 - 40	0.03 - 0.07	0.03 - 0.07	0.05 - 0.09	0.07 - 0.12	0.08 - 0.13	0.09 - 0.15	0.1 - 0.17	0.1 - 0.17	0.1 - 0.18	0.6 x DC	0.25 x DC
H	Hardened steel SKD61, SKT4, etc. 55NiCrMoV7, etc.	40 - 50 HRC	40 - 80	0.03 - 0.07	0.03 - 0.07	0.05 - 0.09	0.07 - 0.12	0.08 - 0.13	0.09 - 0.15	0.1 - 0.17	0.1 - 0.17	0.1 - 0.18	0.6 x DC	0.25 x DC
	Hardened steel SKD11, SKH51, etc. HS6-5-2, etc.	50 - 60 HRC	20 - 60	0.03 - 0.07	0.03 - 0.07	0.05 - 0.09	0.07 - 0.12	0.08 - 0.13	0.09 - 0.15	0.1 - 0.17	0.1 - 0.17	0.1 - 0.18	0.6 x DC	0.25 x DC

VED / VEE: 6 flutes, VED / VEE: 8, 10 flutes, VED: 7, 9 flutes

ISO	Workpiece material	Hardness	Cutting speed V_c (m/min)	Feed per tooth: f_z (mm/t)						Depth of cut a_p (mm)	Width of cut a_e (mm)
				Tool diameter: DC (mm)							
				8	10	12	16	20	25		
S	Titanium alloys Ti-6Al-4V, etc.	- 40 HRC	60 - 120	0.05 - 0.09	0.07 - 0.12	0.08 - 0.13	0.09 - 0.15	0.1 - 0.17	0.1 - 0.17	0.6 x DC	0.02 x DC
	Heat-resistant alloys Inconel 718, etc.	- 40 HRC	30 - 60	0.05 - 0.09	0.07 - 0.12	0.08 - 0.13	0.09 - 0.15	0.1 - 0.17	0.1 - 0.17	0.6 x DC	0.02 x DC
H	Hardened steel SKD61, SKT4, etc. 55NiCrMoV7, etc.	40 - 50 HRC	80 - 160	0.05 - 0.09	0.07 - 0.12	0.08 - 0.13	0.09 - 0.15	0.1 - 0.17	0.1 - 0.17	0.6 x DC	0.02 x DC
	Hardened steel SKD11, SKH51, etc. HS6-5-2, etc.	50 - 60 HRC	40 - 90	0.05 - 0.09	0.07 - 0.12	0.08 - 0.13	0.09 - 0.15	0.1 - 0.17	0.1 - 0.17	0.6 x DC	0.02 x DC



Slotting

VEH, VEE: 3 flutes, VED/VEE: 4 flutes, VEE-A, VEE-I,
VEE-R, VEE-C

ISO	Workpiece material	Hardness	Cutting speed V_c (m/min)	Feed per tooth: f_z (mm/t)									Depth of cut a_p (mm)
				Tool diameter: DC (mm)									
				5	6	8	10	12	16	20	25	32	
P	Carbon steel S45C, S55C, etc. C45, C55, etc.	- 300 HB	50 - 70	0.03 - 0.04	0.03 - 0.04	0.03 - 0.04	0.04 - 0.05	0.05 - 0.06	0.06 - 0.08	0.07 - 0.1	0.07 - 0.1	0.07 - 0.1	0.5 x DC
	Alloy steel SCM440, SCr420, etc. 42CrMo4, 20Cr4, etc.	- 300 HB	40 - 80	0.03 - 0.04	0.03 - 0.04	0.03 - 0.04	0.04 - 0.05	0.05 - 0.06	0.06 - 0.08	0.07 - 0.1	0.07 - 0.1	0.07 - 0.1	0.5 x DC
	Prehardened steel PX5, NAK80, etc.	30 - 40 HRC	40 - 70	0.03 - 0.04	0.03 - 0.04	0.03 - 0.04	0.04 - 0.05	0.05 - 0.06	0.06 - 0.08	0.07 - 0.1	0.07 - 0.1	0.07 - 0.1	0.5 x DC
M	Stainless steel SUS304, SUS316, etc. X5CrNi18-9, X5CrNiMo17-12-2, etc.	- 200 HB	30 - 60	0.03 - 0.04	0.03 - 0.04	0.03 - 0.04	0.04 - 0.05	0.05 - 0.06	0.06 - 0.08	0.07 - 0.1	0.07 - 0.1	0.07 - 0.1	0.5 x DC
K	Grey cast iron FC250, FC300, etc. 250, 300, etc., GG250, GG300, etc.	150 - 250 HB	50 - 120	0.03 - 0.04	0.03 - 0.04	0.03 - 0.04	0.04 - 0.05	0.05 - 0.06	0.06 - 0.08	0.07 - 0.1	0.07 - 0.1	0.07 - 0.1	0.5 x DC
	Ductile cast iron FCD450, etc. 450-10S, etc., GGG450, etc.	150 - 250 HB	50 - 120	0.03 - 0.04	0.03 - 0.04	0.03 - 0.04	0.04 - 0.05	0.05 - 0.06	0.06 - 0.08	0.07 - 0.1	0.07 - 0.1	0.07 - 0.1	0.5 x DC
N	Aluminium alloys Si < 13%	-	130 - 400	0.03 - 0.04	0.03 - 0.04	0.03 - 0.04	0.04 - 0.05	0.05 - 0.06	0.06 - 0.08	0.07 - 0.1	0.07 - 0.1	0.07 - 0.1	0.5 x DC
	Aluminium alloys Si ≥ 13%	-	70 - 200	0.03 - 0.04	0.03 - 0.04	0.03 - 0.04	0.04 - 0.05	0.05 - 0.06	0.06 - 0.08	0.07 - 0.1	0.07 - 0.1	0.07 - 0.1	0.5 x DC
S	Titanium alloys Ti-6Al-4V, etc.	- 40 HRC	20 - 40	0.03 - 0.04	0.03 - 0.04	0.03 - 0.04	0.04 - 0.05	0.05 - 0.06	0.06 - 0.08	0.07 - 0.1	0.07 - 0.1	0.07 - 0.1	0.5 x DC
	Heat-resistant alloys Inconel 718, etc.	- 40 HRC	10 - 20	0.03 - 0.04	0.03 - 0.04	0.03 - 0.04	0.04 - 0.05	0.05 - 0.06	0.06 - 0.08	0.07 - 0.1	0.07 - 0.1	0.07 - 0.1	0.5 x DC
H	Hardened steel SKD61, SKT4, etc. 55NiCrMoV7, etc.	40 - 50 HRC	25 - 60	0.03 - 0.04	0.03 - 0.04	0.03 - 0.04	0.04 - 0.05	0.05 - 0.06	0.06 - 0.08	0.07 - 0.1	0.07 - 0.1	0.07 - 0.1	0.5 x DC
	Hardened steel SKD11, SKH51, etc. HS6-5-2, etc.	50 - 60 HRC	10 - 30	0.03 - 0.04	0.03 - 0.04	0.03 - 0.04	0.04 - 0.05	0.05 - 0.06	0.06 - 0.08	0.07 - 0.1	0.07 - 0.1	0.07 - 0.1	0.5 x DC

VFM...

6 flute, roughing - finishing, for face milling

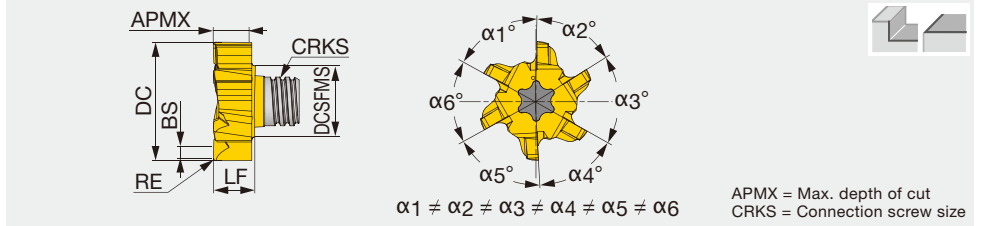

Designation	AH715	NOF	FHA	DC	DCSFMS	APMX	RE	BS	CRKS	LF	Wrench	Torque*
VFM120L03.6R02106S05	●	6	10°	12	7.7	3.6	0.2	1.2	S05	4.4	KEYV-T20	7
VFM160L04.8R04106S06	●	6	10°	16	9.7	4.8	0.4	2	S06	5.6	KEYV-T25	10
VFM200L06.0R04106S08	●	6	10°	20	11.7	6	0.4	2	S08	7	KEYV-T40L	15
VFM250L07.5R04106S10	●	6	10°	25	15.3	7.5	0.4	2	S10	8.55	KEYV-T50L	28

Torque*: Recommended clamping torque (N-m)
2 pieces per package

● : Line up

STANDARD CUTTING CONDITIONS

Face milling

VFM

ISO	Workpiece material	Hardness	Cutting speed Vc (m/min)	Feed per tooth: fz (mm/t)				Depth of cut ap (mm)	Width of cut ae (mm)
				Tool diameter: DC (mm)					
				12	16	20	25		
P	Carbon steel S45C, S55C, etc. C45, C55, etc.	- 300 HB	80 - 180	0.08 - 0.13	0.09 - 0.15	0.1 - 0.17	0.1 - 0.17	1	0.7 x DC
	Alloy steel SCM440, SCr420, etc. 42CrMo4, 20Cr4, etc.	- 300 HB	60 - 140	0.08 - 0.13	0.09 - 0.15	0.1 - 0.17	0.1 - 0.17	1	0.7 x DC
	Prehardened steel PX5, NAK80, etc.	30 - 40 HRC	60 - 120	0.08 - 0.13	0.09 - 0.15	0.1 - 0.17	0.1 - 0.17	1	0.7 x DC
M	Stainless steel SUS304, SUS316, etc. X5CrNi18-9, X5CrNiMo17-12-2, etc.	- 200 HB	40 - 100	0.08 - 0.13	0.09 - 0.15	0.1 - 0.17	0.1 - 0.17	1	0.7 x DC
K	Grey cast iron FC250, FC300, etc. 250, 300, etc., GG250, GG300, etc.	150 - 250 HB	80 - 200	0.08 - 0.13	0.09 - 0.15	0.1 - 0.17	0.1 - 0.17	1	0.7 x DC
	Ductile cast iron FCD450, etc. 450-10S, etc., GGG450, etc.	150 - 250 HB	80 - 200	0.08 - 0.13	0.09 - 0.15	0.1 - 0.17	0.1 - 0.17	1	0.7 x DC
N	Aluminium alloys Si < 13%	-	200 - 700	0.08 - 0.13	0.09 - 0.15	0.1 - 0.17	0.1 - 0.17	1	0.7 x DC
	Aluminium alloys Si ≥ 13%	-	100 - 300	0.08 - 0.13	0.09 - 0.15	0.1 - 0.17	0.1 - 0.17	1	0.7 x DC
S	Titanium alloys Ti-6Al-4V, etc.	- 40 HRC	40 - 80	0.08 - 0.13	0.09 - 0.15	0.1 - 0.17	0.1 - 0.17	1	0.7 x DC
	Heat-resistant alloys Inconel 718, etc.	- 40 HRC	20 - 40	0.08 - 0.13	0.09 - 0.15	0.1 - 0.17	0.1 - 0.17	1	0.7 x DC
H	Hardened steel SKD61, SKT4, etc. 55NiCrMoV7, etc.	40 - 50 HRC	40 - 80	0.08 - 0.13	0.09 - 0.15	0.1 - 0.17	0.1 - 0.17	1	0.7 x DC
	Hardened steel SKD11, SKH51, etc. HS6-5-2, etc.	50 - 60 HRC	20 - 60	0.08 - 0.13	0.09 - 0.15	0.1 - 0.17	0.1 - 0.17	1	0.7 x DC



2 flute, roughing



High feed

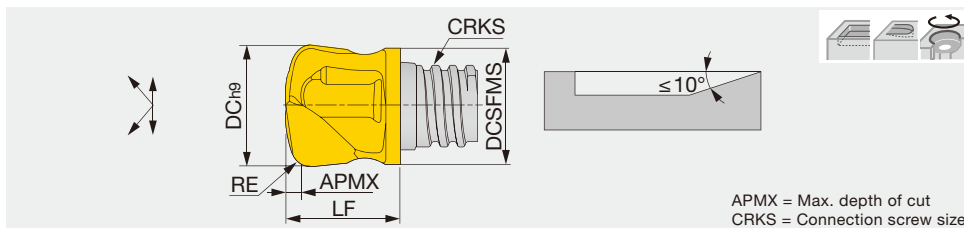

APMX = Max. depth of cut
CRKS = Connection screw size

Designation	AH725	NOF	FHA	DC	DCSFMS	APMX	RE ⁽¹⁾	CRKS	LF	Wrench	Torque*	fz(mm/t)
VFX100L00.6R20-02S06	●	2	0°	10	9.6	0.6	2	S06	12.5	KEYV-S06	10	0.3 - 0.6
VFX120L01.0R25-02S08	●	2	0°	12	11.5	1.0	2.5	S08	11.1	KEYV-S08	15	0.5 - 1
VFX160L01.1R30-02S10	●	2	0°	16	15.2	1.1	3	S10	13.5	KEYV-S10	28	0.55 - 1.1
VFX200L01.5R33-02S12	●	2	0°	20	18.3	1.5	3.3	S12	17.5	KEYV-S12	28	0.75 - 1.5

Torque*: Recommended clamping torque (N-m)

(1) Corner radius for CAM programing

For VFX head, taper neck shank or Tungsten shank should be recommended.

2 pieces per package

● : Line up



Square



Ball



Radius



Chamfering



Slotting



Threading



Others

VFX**-04/06...

4, 6 flute, roughing



High feed

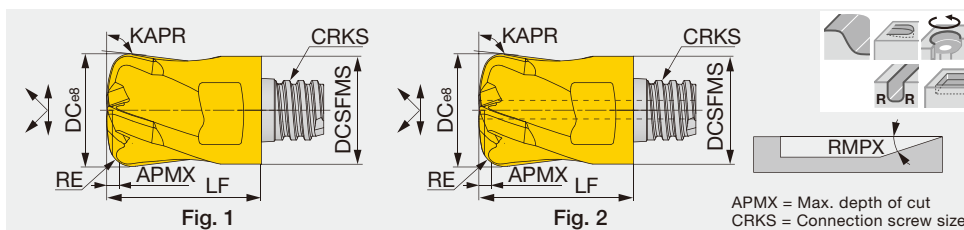

APMX = Max. depth of cut
CRKS = Connection screw size

Designation	AH715	AH725	AH750	NOF	FHA	DC	DCSFMS	APMX	RE	KAPR	CRKS	LF	RMPX	Wrench	Torque*	fz(mm/t)	Fig.
VFX120L0.60R18E04S08	●			4	20°	12	11.5	0.6	1.8	97°	S08	16.5	5°	KEYV-S08	15	0.16 - 0.67	2
VFX120L0.60R18H04S08		●		4	20°	12	11.5	0.6	1.8	97°	S08	16.5	5°	KEYV-S08	15	0.16 - 0.67	1
VFX120L0.65R12E06S08			●	6	20°	12	11.5	0.65	0.6	97°	S08	12	3°	KEYV-S08	15	0.16 - 0.54	2
VFX160L0.80R22E04S10	●			4	20°	16	15.4	0.8	2.2	97°	S10	20.5	5°	KEYV-S10	28	0.2 - 0.75	2
VFX160L0.80R22H04S10		●		4	20°	16	15.4	0.8	2.2	97°	S10	20.5	5°	KEYV-S10	28	0.2 - 0.75	1
VFX160L1.05R20E06S10			●	6	20°	16	15.4	1.05	1	97°	S10	16	3°	KEYV-S10	28	0.2 - 0.65	2

Torque*: Recommended clamping torque (N-m)

Slot milling is not recommended for workpiece materials such as stainless steel where chips tend to adhere.

Also max. ae < 0.4D.

2 pieces per package

● : Line up

STANDARD CUTTING CONDITIONS

High feed milling

VFX: 2, 4, 6 flutes

ISO	Workpiece material	Hardness	Cutting speed Vc (m/min)	ø10		ø12		ø16		ø20		Width of cut ae (mm)
				Feed per tooth fz (mm/t)	Depth of cut ap (mm)	Feed per tooth fz (mm/t)	Depth of cut ap (mm)	Feed per tooth fz (mm/t)	Depth of cut ap (mm)	Feed per tooth fz (mm/t)	Depth of cut ap (mm)	
P	Carbon steel S45C, S55C, etc. C45, C55, etc.	- 300 HB	100 - 200	0.3 - 0.7	0.5	0.4 - 0.8	0.5	0.5 - 0.9	0.75	0.6 - 1	1	0.6 x DC
	Alloy steel SCM440, SCR420, etc. 42CrMo4, 20Cr4, etc.	- 300 HB	80 - 180	0.2 - 0.6	0.5	0.3 - 0.7	0.5	0.4 - 0.8	0.75	0.5 - 0.9	1	0.6 x DC
	Prehardened steel PX5, NAK80, etc.	30 - 40 HRC	80 - 160	0.2 - 0.5	0.4	0.2 - 0.5	0.4	0.3 - 0.6	0.5	0.3 - 0.6	0.75	0.6 x DC
M	Stainless steel SUS304, SUS316, etc. X5CrNi18-9, X5CrNiMo17-12-2, etc.	- 200 HB	60 - 100	0.2 - 0.6	0.4	0.2 - 0.6	0.4	0.3 - 0.7	0.5	0.3 - 0.7	0.75	0.6 x DC
K	Grey cast iron FC250, FC300, etc. 250, 300, etc., GG250, GG300, etc.	150 - 250 HB	100 - 220	0.3 - 0.7	0.5	0.4 - 0.8	0.75	0.5 - 0.9	0.75	0.6 - 1	1	0.6 x DC
	Ductile cast iron FCD450, etc. 450-10S, etc., GGG450, etc.	150 - 250 HB	100 - 220	0.2 - 0.6	0.5	0.3 - 0.7	0.75	0.4 - 0.8	0.75	0.5 - 0.9	1	0.6 x DC
S	Titanium alloys Ti-6Al-4V, etc.	- 40 HRC	40 - 80	0.2 - 0.5	0.4	0.2 - 0.5	0.4	0.2 - 0.6	0.5	0.2 - 0.6	0.5	0.25 x DC
	Heat-resistant alloys Inconel 718, etc.	- 40 HRC	20 - 40	0.1 - 0.3	0.3	0.1 - 0.3	0.3	0.1 - 0.3	0.4	0.1 - 0.3	0.4	0.25 x DC
H	Hardened steel SKD61, SKT4, etc. 55NiCrMoV7, etc.	40 - 50 HRC	40 - 80	0.2 - 0.4	0.3	0.2 - 0.4	0.3	0.3 - 0.5	0.4	0.3 - 0.5	0.4	0.45 x DC
	Hardened steel SKD11, SKH51, etc. HS6-5-2, etc.	50 - 60 HRC	20 - 60	0.1 - 0.2	0.2	0.1 - 0.2	0.2	0.1 - 0.3	0.3	0.1 - 0.3	0.3	0.25 x DC

Please note that the feed per tooth should not exceed the maximum feed per tooth for each product.

Grade

Insert

Ext. Toolholder

Int. Toolholder

Threading

Grooving

Miniature tool

Milling cutter

Endmill

Drilling tool

Tooling System

User's Guide

Index

2 flute, roughing - semi finishing, economical

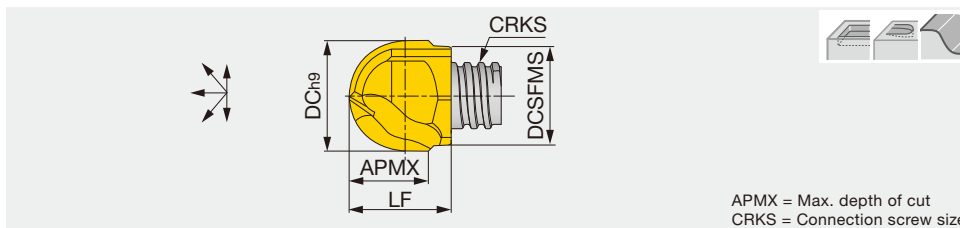

Ball

APMX = Max. depth of cut
CRKS = Connection screw size

Designation	AH725	NOF	FHA	DC	DCSFMS	APMX	CRKS	LF	Wrench	Torque*
VBB080L08.0-BM-02S05	●	2	0°	8	7.6	8	S05	10	KEYV-S05	7
VBB100L10.0-BM-02S06	●	2	0°	10	9.5	10	S06	12.4	KEYV-S06	10
VBB120L12.0-BM-02S08	●	2	0°	12	11.5	11.5	S08	15.3	KEYV-S08	15
VBB160L16.0-BM-02S10	●	2	0°	16	15.2	16	S10	19.1	KEYV-S10	28

Torque*: Recommended clamping torque (N-m)
2 pieces per package

● : Line up



Square



Ball



Radius



Chamfering



Slotting



Threading



Others

VBB-BG...**

2 flute, finishing, high accuracy (h7 tolerance), for hardened steel

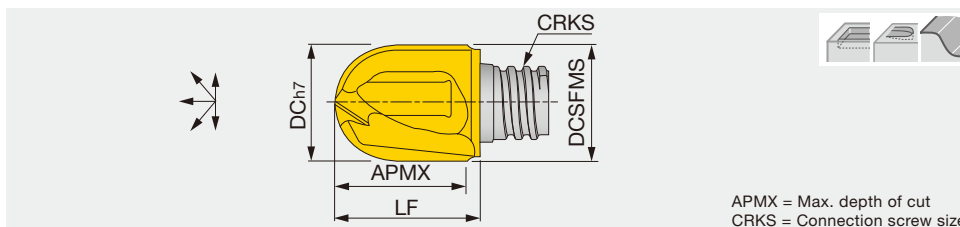

Ball

APMX = Max. depth of cut
CRKS = Connection screw size

Designation	AH750	NOF	FHA	DC	DCSFMS	APMX	CRKS	LF	Wrench	Torque*
VBB080L08.0-BG-02S05	●	2	0°	8	7.6	8	S05	10	KEYV-S05	7
VBB100L10.0-BG-02S06	●	2	0°	10	9.6	10	S06	12.4	KEYV-S06	10
VBB120L12.0-BG-02S08	●	2	0°	12	11.5	12	S08	15.3	KEYV-S08	15
VBB160L16.0-BG-02S10	●	2	0°	16	15.2	16	S10	19.1	KEYV-S10	28

Torque*: Recommended clamping torque (N-m)
2 pieces per package

● : Line up

**VBD**-BG...**

2 flute, semi finishing - finishing, helix cutting edge

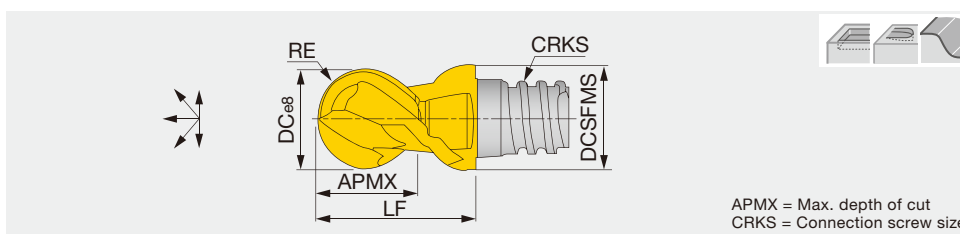

Ball

APMX = Max. depth of cut
CRKS = Connection screw size

Designation	AH725	NOF	FHA	DC	DCSFMS	APMX	RE	CRKS	LF	Wrench	Torque*
VBD080L05.0-BG-02S05	●	2	30°	8	7.7	5	3.982 ⁽¹⁾	S05	10	KEYV-S05	7
VBD100L07.0-BG-02S06	●	2	30°	10	9.7	7	4.982 ⁽¹⁾	S06	13	KEYV-S06	10
VBD120L09.0-BG-02S08	●	2	30°	12	11.7	9	5.978 ⁽²⁾	S08	16.5	KEYV-S08	15
VBD160L09.5-BG-02S10	●	2	30°	16	15.3	9	7.978 ⁽²⁾	S10	20.5	KEYV-S10	28

The tolerance of RE: (1) ± 0.01 (2) ± 0.012
Torque*: Recommended clamping torque (N-m)
2 pieces per package

● : Line up

Reference pages: Standard cutting conditions → **I080**

VBD**-BG-04..., VBE**-BG-04...

4 flute, roughing - finishing, helix cutting edge

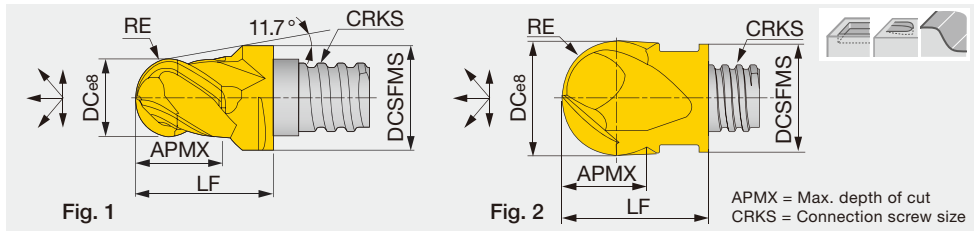
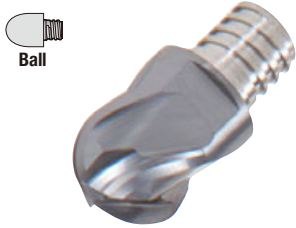

Designation	AH715	AH725	NOF	FHA	DC	DCSFMS	APMX	RE	CRKS	LF	Wrench	Torque*	Fig.
VBE050L04.0-BG-04S04	●	●	4	38°	5	6	4	2.487 ⁽¹⁾	S04	8.5	KEYV-S05	4	1
VBE060L04.0-BG-04S04	●	●	4	38°	6	5.8	4	2.987 ⁽¹⁾	S04	8.5	KEYV-S05	4	2
VBE060L05.5-BG-04S05	●	●	4	38°	6	8	5.5	2.987 ⁽¹⁾	S05	10	KEYV-S05	7	1
VBD080L05.0-BG-04S05	●	●	4	30°	8	7.7	5	3.982 ⁽¹⁾	S05	10	KEYV-S05	7	2
VBD100L07.0-BG-04S06	●	●	4	30°	10	9.7	7	4.982 ⁽¹⁾	S06	13	KEYV-S06	10	2
VBD120L09.0-BG-04S08	●	●	4	30°	12	11.7	9	5.978 ⁽²⁾	S08	16.5	KEYV-S08	15	2
VBD160L12.0-BG-04S10	●	●	4	30°	16	15.3	12	7.978 ⁽²⁾	S10	20.5	KEYV-S10	28	2
VBD200L15.0-BG-04S12	●	●	4	30°	20	18.3	15	9.972 ⁽²⁾	S12	25.5	KEYV-S12	28	2

The tolerance of RE: (1) ± 0.01 (2) ± 0.012

Torque*: Recommended clamping torque (N·m)

VBE060/VBD080 ~ VBD200: 2 pieces per package

VBD250: 1 piece per package

● : Line up

VBB**-SG...

2 flute, roughing - finishing, sphere cutting edge, high accuracy (h7 tolerance)

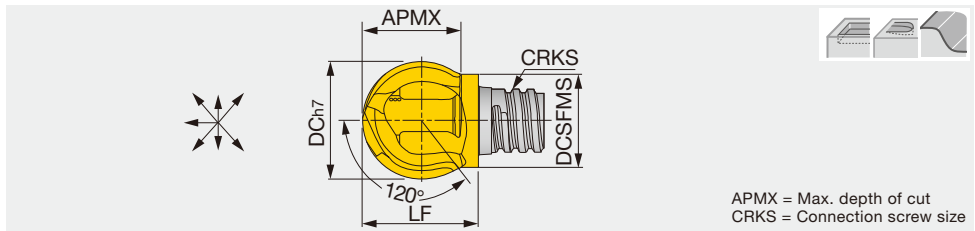

Designation	AH725	NOF	FHA	DC	DCSFMS	APMX	CRKS	LF	Wrench	Torque*
VBB100L08.0-SG-02S05	●	2	0°	10	7.6	7.5	S05	10	KEYV-S05	7
VBB120L09.6-SG-02S06	●	2	0°	12	9.5	9	S06	11.6	***KEYV-S08	10
VBB160L12.9-SG-02S08	●	2	0°	16	12.2	12	S08	15.4	***KEYV-S10	15
VBB200L16.1-SG-02S10	●	2	0°	20	15.2	15	S10	18.4	KEYV-S10	28

Torque*: Recommended clamping torque (N·m)

*** The wrench size for these heads is different from the ones for the other head types.

For pull-cutting on the vertical wall

2 pieces per package

● : Line up

VBE**-BGA...

2 flute, roughing - finishing, for non-ferrous metal, helix cutting edge

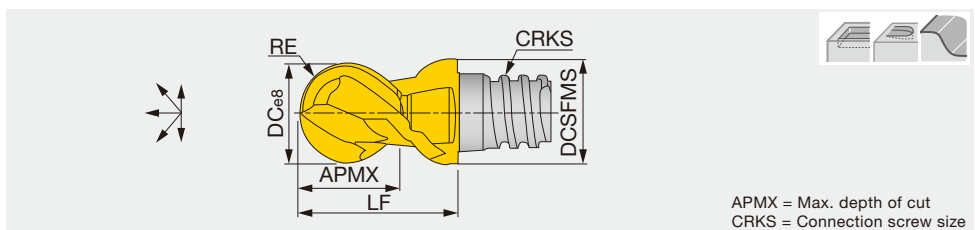

Designation	KS15F	NOF	FHA	DC	DCSFMS	APMX	RE	CRKS	LF	Wrench	Torque*
VBE080L05.0-BGA02S05	●	2	45°	8	7.7	5	3.982 ⁽¹⁾	S05	10	KEYV-S05	7
VBE100L07.0-BGA02S06	●	2	45°	10	9.7	7	4.982 ⁽¹⁾	S06	13	KEYV-S06	10
VBE120L09.0-BGA02S08	●	2	45°	12	11.7	9	5.978 ⁽²⁾	S08	16.5	KEYV-S08	15
VBE160L12.0-BGA02S10	●	2	45°	16	15.3	12	7.978 ⁽²⁾	S10	20.5	KEYV-S10	28
VBE200L15.0-BGA02S12	●	2	45°	20	18.3	15	9.972 ⁽²⁾	S12	25.5	KEYV-S12	28

The tolerance of RE: (1) ± 0.01 (2) ± 0.012

Torque*: Recommended clamping torque (N·m)

2 pieces per package

● : Line up

STANDARD CUTTING CONDITIONS

Profiling for roughing

VBB-BM / BG / SG, VBD-BG, VBE-BGA

ISO	Workpiece material	Hardness	Cutting speed V _c (m/min)	Feed per tooth: fz (mm/t)								Depth of cut a _p (mm)	Pick feed P _f (mm)
				Tool diameter: DC (mm)									
				5	6	8	10	12	16	20	25		
P	Carbon steel S45C, S55C, etc. C45, C55, etc.	- 300 HB	100 - 200	0.03 - 0.07	0.03 - 0.07	0.04 - 0.08	0.05 - 0.1	0.06 - 0.11	0.07 - 0.13	0.08 - 0.15	0.08 - 0.15	0.3 x DC	0.4 x DC
	Alloy steel SCM440, SCr420, etc. 42CrMo4, 20Cr4, etc.	- 300 HB	80 - 180	0.03 - 0.07	0.03 - 0.07	0.04 - 0.08	0.05 - 0.1	0.06 - 0.11	0.07 - 0.13	0.08 - 0.15	0.08 - 0.15	0.3 x DC	0.4 x DC
	Prehardened steel PX5, NAK80, etc.	30 - 40 HRC	80 - 160	0.03 - 0.07	0.03 - 0.07	0.04 - 0.08	0.05 - 0.1	0.06 - 0.11	0.07 - 0.13	0.08 - 0.15	0.08 - 0.15	0.3 x DC	0.4 x DC
M	Stainless steel SUS304, SUS316, etc. X5CrNi18-9, X5CrNiMo17-12-2, etc.	- 200 HB	60 - 100	0.03 - 0.07	0.03 - 0.07	0.04 - 0.08	0.05 - 0.1	0.06 - 0.11	0.07 - 0.13	0.08 - 0.15	0.08 - 0.15	0.3 x DC	0.4 x DC
K	Grey cast iron FC250, FC300, etc. 250, 300, etc., GGG250, GGG300, etc.	150 - 250 HB	100 - 220	0.03 - 0.07	0.03 - 0.07	0.04 - 0.08	0.05 - 0.1	0.06 - 0.11	0.07 - 0.13	0.08 - 0.15	0.08 - 0.15	0.3 x DC	0.4 x DC
	Ductile cast iron FCD450, etc. 450-10S, etc., GGG450, etc.	150 - 250 HB	100 - 220	0.03 - 0.07	0.03 - 0.07	0.04 - 0.08	0.05 - 0.1	0.06 - 0.11	0.07 - 0.13	0.08 - 0.15	0.08 - 0.15	0.3 x DC	0.4 x DC
N	Aluminium alloys Si < 13%	-	200 - 700	0.03 - 0.07	0.03 - 0.07	0.04 - 0.08	0.05 - 0.1	0.06 - 0.11	0.07 - 0.13	0.08 - 0.15	0.08 - 0.15	0.3 x DC	0.4 x DC
	Aluminium alloys Si ≥ 13%	-	100 - 300	0.03 - 0.07	0.03 - 0.07	0.04 - 0.08	0.05 - 0.1	0.06 - 0.11	0.07 - 0.13	0.08 - 0.15	0.08 - 0.15	0.3 x DC	0.4 x DC
S	Titanium alloys Ti-6Al-4V, etc.	- 40 HRC	40 - 80	0.03 - 0.07	0.03 - 0.07	0.04 - 0.08	0.05 - 0.1	0.06 - 0.11	0.07 - 0.13	0.08 - 0.15	0.08 - 0.15	0.3 x DC	0.2 x DC
	Heat-resistant alloys Inconel 718, etc.	- 40 HRC	20 - 40	0.03 - 0.07	0.03 - 0.07	0.04 - 0.08	0.05 - 0.1	0.06 - 0.11	0.07 - 0.13	0.08 - 0.15	0.08 - 0.15	0.3 x DC	0.2 x DC
H	Hardened steel SKD61, SKT4, etc. 55NiCrMoV7, etc.	40 - 50 HRC	40 - 80	0.03 - 0.07	0.03 - 0.07	0.04 - 0.08	0.05 - 0.1	0.06 - 0.11	0.07 - 0.13	0.08 - 0.15	0.08 - 0.15	0.3 x DC	0.2 x DC
	Hardened steel SKD11, SKH51, etc. HS6-5-2, etc.	50 - 60 HRC	20 - 60	0.03 - 0.07	0.03 - 0.07	0.04 - 0.08	0.05 - 0.1	0.06 - 0.11	0.07 - 0.13	0.08 - 0.15	0.08 - 0.15	0.3 x DC	0.2 x DC

Profiling for semi-finishing and finishing

VBB-BM / BG / SG, VBD-BG, VBE-BGA

ISO	Workpiece material	Hardness	Cutting speed V _c (m/min)	Feed per tooth: fz (mm/t)								Depth of cut a _p (mm)	Pick feed P _f (mm)
				Tool diameter: DC (mm)									
				5	6	8	10	12	16	20	25		
P	Carbon steel S45C, S55C, etc. C45, C55, etc.	- 300 HB	120 - 250	0.04 - 0.09	0.04 - 0.09	0.06 - 0.11	0.07 - 0.12	0.08 - 0.13	0.09 - 0.16	0.1 - 0.18	0.1 - 0.18	0.1 x DC	0.15 x DC
	Alloy steel SCM440, SCr420, etc. 42CrMo4, 20Cr4, etc.	- 300 HB	100 - 220	0.04 - 0.09	0.04 - 0.09	0.06 - 0.11	0.07 - 0.12	0.08 - 0.13	0.09 - 0.16	0.1 - 0.18	0.1 - 0.18	0.1 x DC	0.15 x DC
	Prehardened steel PX5, NAK80, etc.	30 - 40 HRC	100 - 200	0.04 - 0.09	0.04 - 0.09	0.06 - 0.11	0.07 - 0.12	0.08 - 0.13	0.09 - 0.16	0.1 - 0.18	0.1 - 0.18	0.1 x DC	0.15 x DC
M	Stainless steel SUS304, SUS316, etc. X5CrNi18-9, X5CrNiMo17-12-2, etc.	- 200 HB	80 - 120	0.04 - 0.09	0.04 - 0.09	0.06 - 0.11	0.07 - 0.12	0.08 - 0.13	0.09 - 0.16	0.1 - 0.18	0.1 - 0.18	0.1 x DC	0.15 x DC
K	Grey cast iron FC250, FC300, etc. 250, 300, etc., GGG250, GGG300, etc.	150 - 250 HB	120 - 280	0.04 - 0.09	0.04 - 0.09	0.06 - 0.11	0.07 - 0.12	0.08 - 0.13	0.09 - 0.16	0.1 - 0.18	0.1 - 0.18	0.1 x DC	0.15 x DC
	Ductile cast iron FCD450, etc. 450-10S, etc., GGG450, etc.	150 - 250 HB	120 - 280	0.04 - 0.09	0.04 - 0.09	0.06 - 0.11	0.07 - 0.12	0.08 - 0.13	0.09 - 0.16	0.1 - 0.18	0.1 - 0.18	0.1 x DC	0.15 x DC
N	Aluminium alloys Si < 13%	-	300 - 1000	0.04 - 0.09	0.04 - 0.09	0.06 - 0.11	0.07 - 0.12	0.08 - 0.13	0.09 - 0.16	0.1 - 0.18	0.1 - 0.18	0.1 x DC	0.15 x DC
	Aluminium alloys Si ≥ 13%	-	150 - 400	0.04 - 0.09	0.04 - 0.09	0.06 - 0.11	0.07 - 0.12	0.08 - 0.13	0.09 - 0.16	0.1 - 0.18	0.1 - 0.18	0.1 x DC	0.15 x DC
S	Titanium alloys Ti-6Al-4V, etc.	- 40 HRC	50 - 100	0.04 - 0.09	0.04 - 0.09	0.06 - 0.11	0.07 - 0.12	0.08 - 0.13	0.09 - 0.16	0.1 - 0.18	0.1 - 0.18	0.08 x DC	0.1 x DC
	Heat-resistant alloys Inconel 718, etc.	- 40 HRC	30 - 50	0.04 - 0.09	0.04 - 0.09	0.06 - 0.11	0.07 - 0.12	0.08 - 0.13	0.09 - 0.16	0.1 - 0.18	0.1 - 0.18	0.08 x DC	0.1 x DC
H	Hardened steel SKD61, SKT4, etc. 55NiCrMoV7, etc.	40 - 50 HRC	50 - 100	0.04 - 0.09	0.04 - 0.09	0.06 - 0.11	0.07 - 0.12	0.08 - 0.13	0.09 - 0.16	0.1 - 0.18	0.1 - 0.18	0.08 x DC	0.1 x DC
	Hardened steel SKD11, SKH51, etc. HS6-5-2, etc.	50 - 60 HRC	30 - 80	0.04 - 0.09	0.04 - 0.09	0.06 - 0.11	0.07 - 0.12	0.08 - 0.13	0.09 - 0.16	0.1 - 0.18	0.1 - 0.18	0.08 x DC	0.1 x DC

VRB**-02..., VRC**-02...

2 flute, roughing - semi finishing, economical



Radius

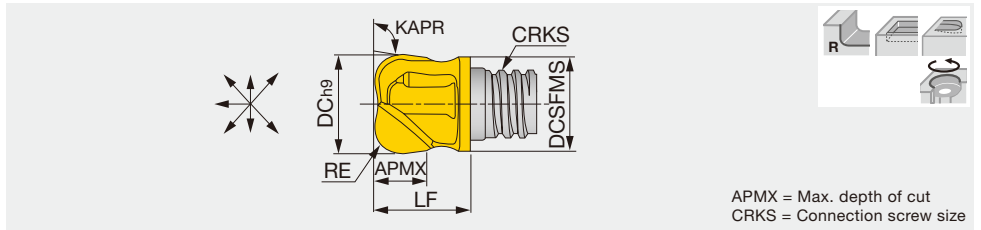

APMX = Max. depth of cut
CRKS = Connection screw size

Designation	AH725	NOF	FHA	DC	DCSFMS	APMX	RE	KAPR	CRKS	LF	Wrench	Torque*
VRC100L07.0R10-02S06	●	2	15°	10	9.5	7	1	95°	S06	12.4	KEYV-S06	10
VRB100L06.0R20-02S06	●	2	0°	10	9.2	6	2	97°	S06	12.4	KEYV-S06	10
VRB120L05.7R30-02S06	●	2	0°	12	9.5	5.7	3	97°	S06	9.1	***KEYV-S08	10
VRB120L05.4R40-02S06	●	2	0°	12	9.5	5.4	4	97°	S06	9.1	***KEYV-S08	10
VRB120L06.3R16-02S08	●	2	0°	12	11.5	5.9	1.6	97°	S08	11.1	KEYV-S08	15
VRB120L06.2R20-02S08	●	2	0°	12	11.5	6.2	2	97°	S08	11.1	KEYV-S08	15
VRB120L06.1R25-02S08	●	2	0°	12	11.5	5.8	2.5	97°	S08	11.1	KEYV-S08	15
VRB120L06.1R30-02S08	●	2	0°	12	11.5	5.7	3	97°	S08	11.1	KEYV-S08	15
VRB120L05.9R40-02S08	●	2	0°	12	11.5	5.5	4	97°	S08	11.1	KEYV-S08	15
VRB160L08.0R50-02S10	●	2	0°	16	15.2	8	5	97°	S10	20.2	KEYV-S10	28
VRB200L11.1R30-02S12	●	2	0°	20	18.3	11	3	97°	S12	17	KEYV-S12	28
VRB200L11.5R40-02S12	●	2	0°	20	18.3	11.3	4	97°	S12	17.3	KEYV-S12	28
VRB200L11.5R50-02S12	●	2	0°	20	18.3	11.3	5	97°	S12	17.3	KEYV-S12	28
VRB200L11.4R60-02S12	●	2	0°	20	18.3	11.2	6	97°	S12	17.3	KEYV-S12	28
VRB200L11.3R80-02S12	●	2	0°	20	18.3	11.1	8	97°	S12	17.3	KEYV-S12	28

Torque*: Recommended clamping torque (N-m)

*** The wrench size for these heads is different from the ones for the other head types.

Suitable for contouring operation.

2 pieces per package

● : Line up

VRD**-06...

6 flute, semi finishing - finishing, helix cutting edge



Radius

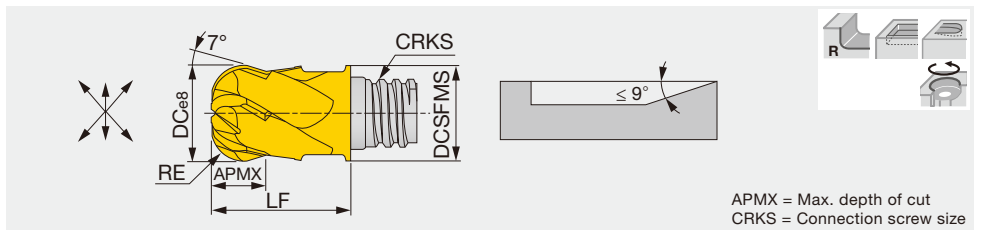

APMX = Max. depth of cut
CRKS = Connection screw size

Designation	AH725	NOF	FHA	DC	DCSFMS	APMX	RE	CRKS	LF	Wrench	Torque*
VRD080L04.0R20-06S05	●	6	30°	8	7.7	4	2	S05	10	KEYV-S05	7
VRD100L05.0R30-06S06	●	6	30°	10	9.7	5	3	S06	13	KEYV-S06	10
VRD120L07.0R40-06S08	●	6	30°	12	11.7	7	4	S08	16.5	KEYV-S08	15
VRD160L09.0R50-06S10	●	6	30°	16	15.3	9	5	S10	20.5	KEYV-S10	28

Torque*: Recommended clamping torque (N-m)

2 pieces per package

● : Line up

Reference pages: Standard cutting conditions → [I082](#)

STANDARD CUTTING CONDITIONS

Shoulder milling

VRB, VRC, VRD

ISO	Workpiece material	Hardness	Cutting speed V_c (m/min)	Feed per tooth: f_z (mm/t)					Depth of cut a_p (mm)	Width of cut a_e (mm)
				Tool diameter: DC (mm)						
				8	10	12	16	20		
P	Carbon steel S45C, S55C, etc. C45, C55, etc.	- 300 HB	80 - 180	0.05 - 0.09	0.07 - 0.12	0.08 - 0.13	0.09 - 0.15	0.1 - 0.17	0.6 x DC	0.25 x DC
	Alloy steel SCM440, SCr420, etc. 42CrMo4, 20Cr4, etc.	- 300 HB	60 - 140	0.05 - 0.09	0.07 - 0.12	0.08 - 0.13	0.09 - 0.15	0.1 - 0.17	0.6 x DC	0.25 x DC
	Prehardened steel PX5, NAK80, etc.	30 - 40 HRC	60 - 120	0.05 - 0.09	0.07 - 0.12	0.08 - 0.13	0.09 - 0.15	0.1 - 0.17	0.6 x DC	0.25 x DC
M	Stainless steel SUS304, SUS316, etc. X5CrNi18-9, X5CrNiMo17-12-2, etc.	- 200 HB	40 - 100	0.05 - 0.09	0.07 - 0.12	0.08 - 0.13	0.09 - 0.15	0.1 - 0.17	0.6 x DC	0.25 x DC
K	Grey cast iron FC250, FC300, etc. 250, 300, etc., GG250, GG300, etc.	150 - 250 HB	80 - 200	0.05 - 0.09	0.07 - 0.12	0.08 - 0.13	0.09 - 0.15	0.1 - 0.17	0.6 x DC	0.25 x DC
	Ductile cast iron FCD450, etc. 450-10S, etc., GGG450, etc.	150 - 250 HB	80 - 200	0.05 - 0.09	0.07 - 0.12	0.08 - 0.13	0.09 - 0.15	0.1 - 0.17	0.6 x DC	0.25 x DC
N	Aluminium alloys Si < 13%	-	200 - 700	0.05 - 0.09	0.07 - 0.12	0.08 - 0.13	0.09 - 0.15	0.1 - 0.17	0.6 x DC	0.25 x DC
	Aluminium alloys Si ≥ 13%	-	100 - 300	0.05 - 0.09	0.07 - 0.12	0.08 - 0.13	0.09 - 0.15	0.1 - 0.17	0.6 x DC	0.25 x DC
S	Titanium alloys Ti-6Al-4V, etc.	- 40 HRC	40 - 80	0.05 - 0.09	0.07 - 0.12	0.08 - 0.13	0.09 - 0.15	0.1 - 0.17	0.6 x DC	0.25 x DC
	Heat-resistant alloys Inconel 718, etc.	- 40 HRC	20 - 40	0.05 - 0.09	0.07 - 0.12	0.08 - 0.13	0.09 - 0.15	0.1 - 0.17	0.6 x DC	0.25 x DC
H	Hardened steel SKD61, SKT4, etc. 55NiCrMoV7, etc.	40 - 50 HRC	40 - 80	0.05 - 0.09	0.07 - 0.12	0.08 - 0.13	0.09 - 0.15	0.1 - 0.17	0.6 x DC	0.25 x DC
	Hardened steel SKD11, SKH51, etc. HS6-5-2, etc.	50 - 60 HRC	20 - 60	0.05 - 0.09	0.07 - 0.12	0.08 - 0.13	0.09 - 0.15	0.1 - 0.17	0.6 x DC	0.25 x DC

Slotting

VRB, VRC, VRD

ISO	Workpiece material	Hardness	Cutting speed V_c (m/min)	Feed per tooth: f_z (mm/t)					Depth of cut a_p (mm)
				Tool diameter: DC (mm)					
				8	10	12	16	20	
P	Carbon steel S45C, S55C, etc. C45, C55, etc.	- 300 HB	50 - 70	0.03 - 0.04	0.04 - 0.05	0.05 - 0.06	0.06 - 0.08	0.07 - 0.1	0.5 x DC
	Alloy steel SCM440, SCr420, etc. 42CrMo4, 20Cr4, etc.	- 300 HB	40 - 80	0.03 - 0.04	0.04 - 0.05	0.05 - 0.06	0.06 - 0.08	0.07 - 0.1	0.5 x DC
	Prehardened steel PX5, NAK80, etc.	30 - 40 HRC	40 - 70	0.03 - 0.04	0.04 - 0.05	0.05 - 0.06	0.06 - 0.08	0.07 - 0.1	0.5 x DC
M	Stainless steel SUS304, SUS316, etc. X5CrNi18-9, X5CrNiMo17-12-2, etc.	- 200 HB	30 - 60	0.03 - 0.04	0.04 - 0.05	0.05 - 0.06	0.06 - 0.08	0.07 - 0.1	0.5 x DC
K	Grey cast iron FC250, FC300, etc. 250, 300, etc., GG250, GG300, etc.	150 - 250 HB	50 - 120	0.03 - 0.04	0.04 - 0.05	0.05 - 0.06	0.06 - 0.08	0.07 - 0.1	0.5 x DC
	Ductile cast iron FCD450, etc. 450-10S, etc., GGG450, etc.	150 - 250 HB	50 - 120	0.03 - 0.04	0.04 - 0.05	0.05 - 0.06	0.06 - 0.08	0.07 - 0.1	0.5 x DC
N	Aluminium alloys Si < 13%	-	130 - 400	0.03 - 0.04	0.04 - 0.05	0.05 - 0.06	0.06 - 0.08	0.07 - 0.1	0.5 x DC
	Aluminium alloys Si ≥ 13%	-	70 - 200	0.03 - 0.04	0.04 - 0.05	0.05 - 0.06	0.06 - 0.08	0.07 - 0.1	0.5 x DC
S	Titanium alloys Ti-6Al-4V, etc.	- 40 HRC	20 - 40	0.03 - 0.04	0.04 - 0.05	0.05 - 0.06	0.06 - 0.08	0.07 - 0.1	0.5 x DC
	Heat-resistant alloys Inconel 718, etc.	- 40 HRC	10 - 20	0.03 - 0.04	0.04 - 0.05	0.05 - 0.06	0.06 - 0.08	0.07 - 0.1	0.5 x DC
H	Hardened steel SKD61, SKT4, etc. 55NiCrMoV7, etc.	40 - 50 HRC	25 - 60	0.03 - 0.04	0.04 - 0.05	0.05 - 0.06	0.06 - 0.08	0.07 - 0.1	0.5 x DC
	Hardened steel SKD11, SKH51, etc. HS6-5-2, etc.	50 - 60 HRC	10 - 30	0.03 - 0.04	0.04 - 0.05	0.05 - 0.06	0.06 - 0.08	0.07 - 0.1	0.5 x DC

VBO...

4, 5 flute, semi finishing - finishing, long edge, high productive profiling

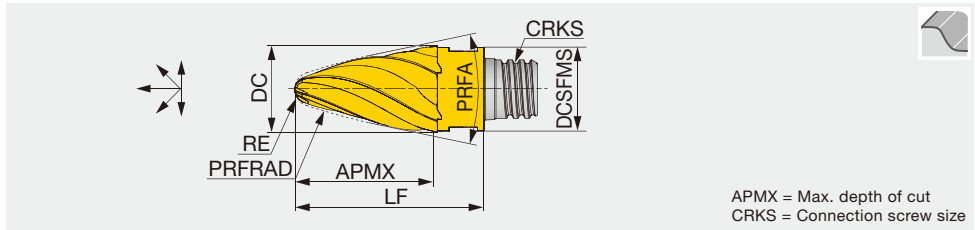

Designation	AH715	NOF	FHA	DC	DCSFMS	APMX	RE	PRFRAD	PRFA	CRKS	LF	Wrench	Torque*
VBO080L12.0R900-4S05	●	4	30°	8	7.7	12	1	90	33.6°	S05	18	KEYV-S05	7
VBO100L15.0R850-5S06	●	5	30°	10	9.7	15	2	85	27.3°	S06	22	KEYV-S06	10
VBO120L19.0R800-5S08	●	5	30°	12	11.7	19	2	80	29.3°	S08	27	KEYV-S08	15
VBO160L25.0R750-5S10	●	5	30°	16	15.3	25	3	75	26.7°	S10	33.5	KEYV-S10	28

Torque*: Recommended clamping torque (N-m)
2 pieces per package

● : Line up

VBO...

4 flute, semi finishing - finishing, short edge, high productive profiling

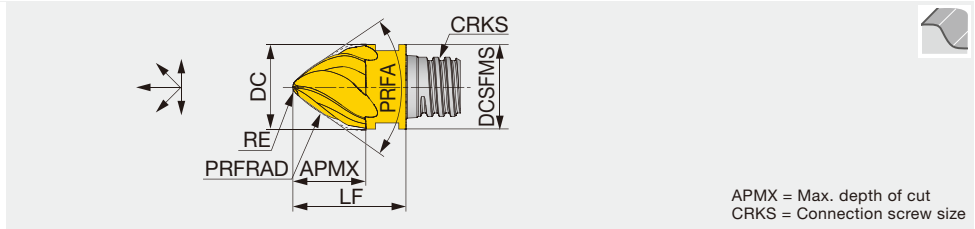

Designation	AH715	NOF	FHA	DC	DCSFMS	APMX	RE	PRFRAD	PRFA	CRKS	LF	Wrench	Torque*
VBO100L08.0R250-4S06	●	4	30°	10	9.7	8	0.8	25	70.8°	S06	13	KEYV-S06	10
VBO120L09.0R300-4S08	●	4	30°	12	11.7	9	1.2	30	71.6°	S08	16.5	KEYV-S08	15
VBO160L13.0R400-4S10	●	4	30°	16	15.3	13	1.6	40	70.3°	S10	20.5	KEYV-S10	28

Torque*: Recommended clamping torque (N-m)
2 pieces per package

● : Line up

VBN...

6 flute, semi finishing - finishing, high productive profiling

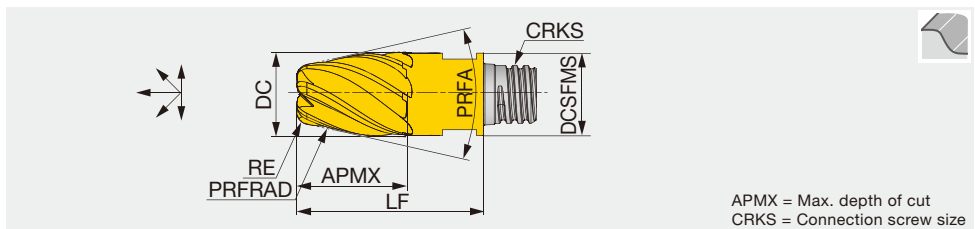

Designation	AH715	NOF	FHA	DC	DCSFMS	APMX	RE	PRFRAD	PRFA	CRKS	LF	Wrench	Torque*
VBN100L13.0R450-6S06	●	6	35°	10	9.7	13	1.5	45	15.1°	S06	22	KEYV-S06	10
VBN120L15.0R500-6S08	●	6	35°	12	11.7	15	2	50	15.1°	S08	27	KEYV-S08	15
VBN160L18.0R600-6S10	●	6	35°	16	15.3	18	2	60	15.1°	S10	33.5	KEYV-S10	28

Torque*: Recommended clamping torque (N-m)
2 pieces per package

● : Line up

Reference pages: Standard cutting conditions → I085

6 flute, semi finishing - finishing, high productive profiling

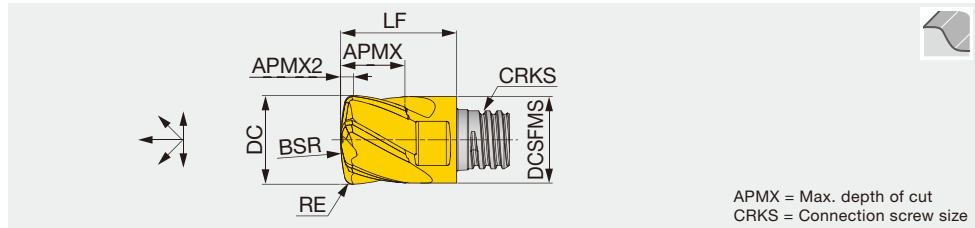

Lens

APMX = Max. depth of cut
CRKS = Connection screw size

Designation	AH715	NOF	FHA	DC	DCSFMS	APMX	APMX2	RE	BSR	CRKS	LF	Wrench	Torque*
VBL080L0.90R160-6S05	●	6	30°	8	7.7	5.5	0.9	0.5	16	S05	10	KEYV-S05	7
VBL100L1.40R200-6S06	●	6	30°	10	9.7	7.5	1.42	1	20	S06	13	KEYV-S06	10
VBL120L1.50R240-6S08	●	6	30°	12	11.7	9	1.55	1	24	S08	16.5	KEYV-S08	15
VBL160L1.80R320-6S10	●	6	30°	16	15.3	12	1.8	1	32	S10	20.5	KEYV-S10	28

Torque*: Recommended clamping torque (N-m)
2 pieces per package

● : Line up



Others



TARGET APPLICATIONS

VBO-short

Convex-curved surfaces, tapered surfaces, and surfaces consisting of combinations of a small corner radius and walls (the corner radius must be larger than the tool's nose radius).



VBO-long

Convex-curved and tapered surfaces in gentler profile than those of VBO-short.



VBN

Impellers, blisks, blades, and other aerospace parts.

Reference pages: Standard cutting conditions → **I085**

STANDARD CUTTING CONDITIONS

Profiling

VBO, VBN, VBL

ISO	Workpiece material	Hardness	Cutting speed Vc (m/min)	Feed per tooth: fz (mm/t)			Cusp height (mm)
				Tool diameter: DC (mm)			
				10	12	16	
P	Low carbon steel S45C, S55C, etc. C45, C55, etc.	- 300 HB	100 - 200	0.05 - 0.1	0.06 - 0.11	0.07 - 0.13	0.1
	High carbon steel SCM440, SCr415, etc. 42CrMo4, 15Cr3, etc.	- 300 HB	80 - 180	0.05 - 0.1	0.06 - 0.11	0.07 - 0.13	0.1
	Prehardened steel PX5, NAK80, etc.	30 - 40 HRC	80 - 160	0.05 - 0.1	0.06 - 0.11	0.07 - 0.13	0.1
M	Stainless steel SUS304, SUS316, etc. X5CrNi18-9, X5CrNiMo17-12-2, etc.	- 200 HB	60 - 100	0.05 - 0.1	0.06 - 0.11	0.07 - 0.13	0.1
K	Grey cast iron FC250, FC300, etc. 250, 300, etc.	150 - 250 HB	100 - 220	0.05 - 0.1	0.06 - 0.11	0.07 - 0.13	0.1
	Ductile cast iron FCD400, etc. 400-15S, etc.	150 - 250 HB	100 - 220	0.05 - 0.1	0.06 - 0.11	0.07 - 0.13	0.1
N	Aluminium alloys Si < 13%	-	200 - 700	0.05 - 0.1	0.06 - 0.11	0.07 - 0.13	0.1
	Aluminium alloys Si ≥ 13%	-	100 - 300	0.05 - 0.1	0.06 - 0.11	0.07 - 0.13	0.1
S	Titanium alloys Ti-6Al-4V, etc.	- 40 HRC	40 - 80	0.05 - 0.1	0.06 - 0.11	0.07 - 0.13	0.1
	Heat-resistant alloys Inconel718, etc.	50 - 60 HRC	20 - 40	0.05 - 0.1	0.06 - 0.11	0.07 - 0.13	0.1
H	Hardened steel SKD61, SKT4, etc. X40CrMoV5-1, 55NiCrMoV7, etc.	-	40 - 80	0.05 - 0.1	0.06 - 0.11	0.07 - 0.13	0.1
	Hardened steel SKD11, SKH, etc. X153CrMoV12, HS18-0-1, etc.	50 - 60 HRC	20 - 60	0.05 - 0.1	0.06 - 0.11	0.07 - 0.13	0.1

TIPS FOR USING ON 3-AXIS MACHINES

The **VBO/VBN** milling heads are designed for the use on 5-axis machines. However, they are also effective on 3-axis machining centers when either of the following conditions is satisfied.

1. The angled walls or curved surfaces to be machined have tilt angles within the range specified in the chart on the right.
2. Use as a regular tapered ball mill with only the nose radius of the tool tip, and not the radius on the tool side, to be used. Please note that the working diameter will be smaller than those of a ball mill of the same working diameter.

	Designation	Applicable ranges of tilt angles on workpiece		
		Min.	Mean	Max.
VBO-short	VBO100L08.0R250-4S06	56°	70.8°	85°
	VBO120L09.0R300-4S08	58°	71.6°	85°
	VBO160L13.0R400-4S10	56°	70.3°	85°
VBO-long	VBO100L15.0R850-5S06	20°	27.3°	35°
	VBO120L19.0R800-5S08	19°	29.3°	40°
	VBO160L25.0R750-5S10	10°	26.7°	43°
VBN	VBN100L13.0R450-6S06	0°	15.1°	29°
	VBN120L15.0R500-6S08	0°	15.1°	29°
	VBN160L18.0R600-6S10	0°	15.1°	29°

4, 6 flute, chamfering angle: 45°

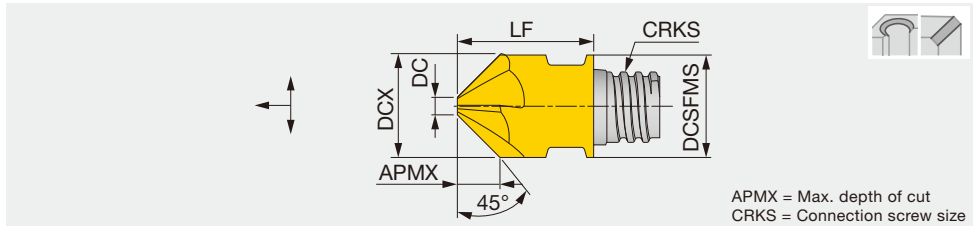

Chamfering

APMX = Max. depth of cut
CRKS = Connection screw size

Designation	AH715	AH725	NOF	FHA	DCX	DCSFMS	APMX	DC	CRKS	LF	Wrench	Torque*
VCA100L04.0A45-04S06	●	●	4	0°	10	10	4	1.95	S06	13	KEYV-S06	10
VCA120L05.0A45-04S08	●	●	4	0°	12	12	5	1.95	S08	16.5	KEYV-S08	15
VCA127L05.3A45-04S08		●	4	0°	12.7	12.7	5.3	1.98	S08	16.5	KEYV-S08	15
VCA160L06.5A45-06S10	●	●	6	0°	16	16	6.5	3	S10	20.3	KEYV-S10	28
VCA200L07.5A45-06S12		●	6	0°	20	18.3	7.5	5	S12	25.5	KEYV-S12	28

Torque*: Recommended clamping torque (N·m)
2 pieces per package

● : Line up



Square



Ball



Radius



Chamfering



Slotting



Threading



Others

VCW-02...**

2 flute, chamfering angle: 45°, back chamfering capability

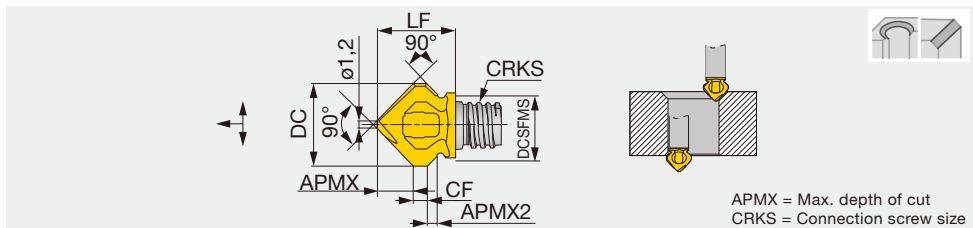

Chamfering

APMX = Max. depth of cut
CRKS = Connection screw size

Designation	AH715	AH725	NOF	FHA	DC	DCSFMS	APMX	APMX2	CF	CRKS	LF	Wrench	Torque*
VCW118L05.0A45-02S06	●	●	2	0°	11.8	9.3	5	1.2	2	S06	11.2	***KEYV-S08	10

Torque*: Recommended clamping torque (N·m)

*** The wrench size for these heads is different from the ones for the other head types.

Available for chamfering of reverse side.

2 pieces per package

● : Line up

**VCR**-02...**

2 flute, radius chamfering

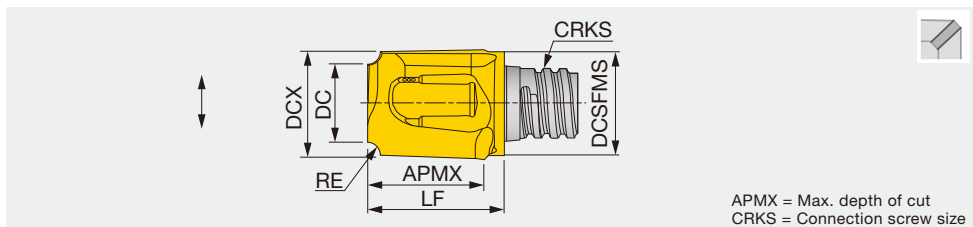

Chamfering

APMX = Max. depth of cut
CRKS = Connection screw size

Designation	AH725	NOF	FHA	DCX	DCSFMS	DC	APMX	RE	CRKS	LF	Wrench	Torque*
VCR080L07.5R10-02S05	●	2	0°	8	7.6	5.8	7.5	1	S05	10.5	KEYV-S05	7
VCR100L09.5R16-02S06	●	2	0°	10	9.5	6.8	9.5	1.6	S06	12.5	KEYV-S06	10
VCR100L09.5R25-02S06	●	2	0°	10	9.5	5.1	9.5	2.5	S06	12.5	KEYV-S06	10
VCR127L12.0R30-02S08	●	2	0°	12.7	12.2	6.5	12	3	S08	15.6	KEYV-S08	15
VCR127L12.0R40-02S08	●	2	0°	12.7	12.2	4.7	12	4	S08	15.6	KEYV-S08	15
VCR160L15.0R50-02S10	●	2	0°	16	15.2	6.2	15	5	S10	19.1	KEYV-S10	28
VCR200L07.0R60-02S12	●	2	0°	20	18.3	8	7	6	S12	17.4	KEYV-S12	28

Torque*: Recommended clamping torque (N·m)
2 pieces per package

● : Line up

Reference pages: Standard cutting conditions → **I087**

STANDARD CUTTING CONDITIONS

Chamfering and countersinking (Milling, Z-feed chamfering)

VCA, VCW, VCR

ISO	Workpiece material	Hardness	Cutting speed Vc (m/min)	Feed per tooth fz (mm/t)
P	Carbon steel S45C, S55C, etc. C45, C55, etc.	- 300 HB	60 - 100	0.03 - 0.06
	Alloy steel SCM440, SCr420, etc. 42CrMo4, 20Cr4, etc.	- 300 HB	50 - 80	0.03 - 0.06
	Prehardened steel PX5, NAK80, etc.	30 - 40 HRC	40 - 70	0.03 - 0.06
M	Stainless steel SUS304, SUS316, etc. X5CrNi18-9, X5CrNiMo17-12-2, etc.	- 200 HB	30 - 50	0.03 - 0.06
K	Grey cast iron FC250, FC300, etc. 250, 300, etc., GG250, GG300, etc.	150 - 250 HB	80 - 120	0.03 - 0.06
	Ductile cast iron FCD450, etc. 450-10S, etc., GGG450, etc.	150 - 250 HB	80 - 120	0.03 - 0.06
N	Aluminium alloys	-	100 - 200	0.04 - 0.08
S	Titanium alloys Ti-6Al-4V, etc.	- 40 HRC	30 - 50	0.025 - 0.05
	Heat-resistant alloys Inconel 718, etc.	- 40 HRC	20 - 40	0.02 - 0.04
H	Hardened steel SKD61, SKT4, etc. 55NiCrMoV7, etc.	40 - 50 HRC	30 - 50	0.025 - 0.05
	Hardened steel SKD11, SKH51, etc. HS6-5-2, etc.	50 - 60 HRC	20 - 40	0.02 - 0.04

Grade

Insert

Ext. Toolholder

Int. Toolholder

Threading

Grooving

Miniature tool

Milling cutter

Endmill

Drilling tool

Tooling System

User's Guide

Index

2 flute, chamfering angle: 30°, 45°, 60°

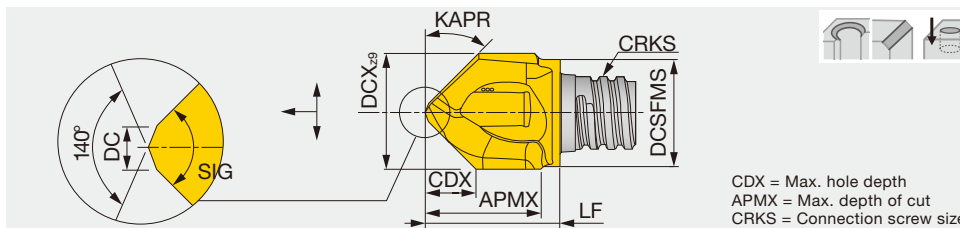
Chamfering
Spot drillDCX = Max. hole depth
APMX = Max. depth of cut
CRKS = Connection screw size

Designation	AH715	AH725	SIG	NOF	FHA	DCX	DCSFMS	APMX	CDX	CRKS	LF	DC	KAPR	Wrench	Torque*
VCP100L09.5A30-02S06	●		60°	2	0°	10	9.5	8.5	7.5	S06	11.75	1.5	60°	KEYV-S06	10
VCP120L12.0A30-02S08	●	●	60°	2	0°	12	11.5	11	9.2	S08	15.4	1.5	60°	KEYV-S08	15
VCP160L15.0A30-02S10	●	●	60°	2	0°	16	15.2	16	12	S10	20.2	2.5	60°	KEYV-S10	28
VCP080L07.7A45-02S05	●	●	90°	2	0°	8	7.6	7.5	3.7	S05	9.75	1	45°	KEYV-S05	7
VCP083L07.9A45-02S05	●	●	90°	2	0°	8.3	7.6	7.5	3.8	S05	10	1	45°	KEYV-S05	7
VCP100L09.0A45-02S06	●	●	90°	2	0°	10	9.5	9.5	4.4	S06	11.75	1.5	45°	KEYV-S06	10
VCP104L09.0A45-02S06	●	●	90°	2	0°	10.4	9.5	9.5	4.6	S06	11.75	1.5	45°	KEYV-S06	10
VCP120L12.0A45-02S08	●	●	90°	2	0°	12	11.5	11.5	5.4	S08	15.4	1.5	45°	KEYV-S08	15
VCP124L12.0A45-02S08	●	●	90°	2	0°	12.4	11.5	11.5	5.6	S08	15.4	1.5	45°	KEYV-S08	15
VCP160L15.0A45-02S10	●	●	90°	2	0°	16	15.2	15	7.1	S10	18.8	1.5	45°	KEYV-S10	28
VCP165L15.0A45-02S10	●	●	90°	2	0°	16.5	15.2	15	7.1	S10	18.8	1.5	45°	KEYV-S10	28
VCP100L09.5A60-02S06	●		120°	2	0°	10	9.5	9.5	2.7	S06	12.7	1.5	30°	KEYV-S06	10
VCP120L12.0A60-02S08	●	●	120°	2	0°	12	11.5	11.5	3.3	S08	15.2	1.5	30°	KEYV-S08	15
VCP160L15.5A60-02S10	●	●	120°	2	0°	16	15.2	16	4.4	S10	19.9	1.5	30°	KEYV-S10	28

Torque*: Recommended clamping torque (N-m)
2 pieces per package

● : Line up



Square



Ball



Radius



Chamfering



Slotting



Threading



Others

VDS...

2 flute, chamfering angle: 45°, helix cutting edge

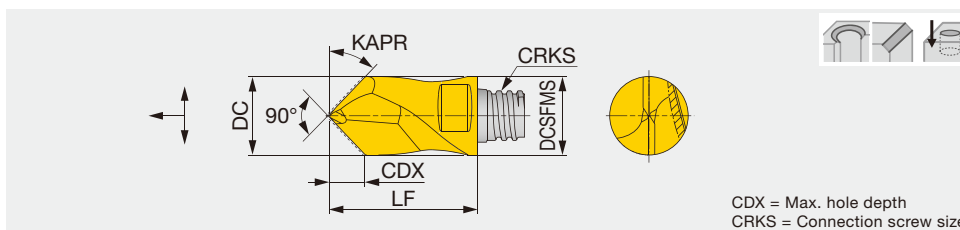
Chamfering
Spot drillCDX = Max. hole depth
CRKS = Connection screw size

Designation	AH725	NOF	FHA	DC	DCSFMS	CDX	KAPR	CRKS	LF	Wrench	Torque*
VDS080A45-02S05	●	2	10°	8	7.7	3.7	45°	S05	15	KEYV-S05	7
VDS100A45-02S06	●	2	10°	10	9.7	4.4	45°	S06	19	KEYV-S06	10
VDS120A45-02S08	●	2	10°	12	11.7	5.4	45°	S08	23	KEYV-S08	15
VDS160A45-02S10	●	2	10°	16	15.3	7.1	45°	S10	28	KEYV-S10	28

Torque*: Recommended clamping torque (N-m)
2 pieces per package

● : Line up

STANDARD CUTTING CONDITIONS

Spot drill
VCP, VDS

ISO	Workpiece material	Hardness	Cutting speed Vc (m/min)	Feed f (mm/rev)
P	Carbon steel S45C, S55C, etc. C45, C55, etc.	- 300 HB	60 - 100	0.06 - 0.12
	Alloy steel SCM440, SCr420, etc. 42CrMo4, 20Cr4, etc.	- 300 HB	50 - 80	0.06 - 0.12
	Prehardened steel PX5, NAK80, etc.	30 - 40 HRC	40 - 70	0.06 - 0.12
M	Stainless steel SUS304, SUS316, etc. X5CrNi18-9, X5CrNiMo17-12-2, etc.	- 200 HB	30 - 50	0.06 - 0.12
K	Grey cast iron FC250, FC300, etc. 250, 300, etc., GG250, GG300, etc.	150 - 250 HB	80 - 120	0.06 - 0.12
	Ductile cast iron FCD450, etc. 450-10S, etc., GGG450, etc.	150 - 250 HB	80 - 120	0.06 - 0.12
N	Aluminium alloys	-	100 - 200	0.08 - 0.16
S	Titanium alloys Ti-6Al-4V, etc.	- 40 HRC	30 - 50	0.05 - 0.1
	Heat-resistant alloys Inconel 718, etc.	- 40 HRC	20 - 40	0.04 - 0.08
H	Hardened steel SKD61, SKT4, etc. 55NiCrMoV7, etc.	40 - 50 HRC	30 - 50	0.05 - 0.1
	Hardened steel SKD11, SKH51, etc. HS6-5-2, etc.	50 - 60 HRC	20 - 40	0.04 - 0.08

Grade

Insert

Ext. Toolholder

Int. Toolholder

Threading

Grooving

Miniature tool

Milling cutter

Endmill

Drilling tool

Tooling System

User's Guide

Index





Center hole

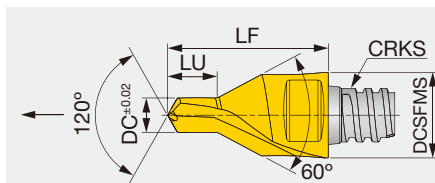

Fig. 1 Type A

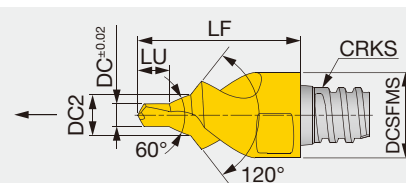

Fig. 2 Type B

CRKS = Connection screw size

Designation	AH725	NOF	FHA	DC±0.02	DC2	DCSFMS	LU	CRKS	LF	Wrench	Torque*	Fig.
VDP107L1.60A30-02S04	●	2	0°	1.07	-	6	1.6	S04	10	KEYV-S05	4	1
VDP165L2.40A30-02S04	●	2	0°	1.65	-	6	2.4	S04	10	KEYV-S05	4	1
VDP207L2.90A30-02S04	●	2	0°	2.07	-	6	2.9	S04	10	KEYV-S05	4	1
VDP328L04.6A30-02S05	●	2	0°	3.28	-	8	4.6	S05	15	KEYV-S05	7	1
VDP412L05.9A30-02S06	●	2	0°	4.12	-	10	5.9	S06	19	KEYV-S06	10	1
VDP513L07.2A30-02S08	●	2	0°	5.13	-	12	7.2	S08	23	KEYV-S08	15	1
VDP646L08.9A30-02S10	●	2	0°	6.46	-	16	8.9	S10	28	KEYV-S10	28	1
VDP324L4.38B30-02S08	●	2	0°	3.24	6.77	12	4.4	S08	23	KEYV-S08	15	2
VDP409L5.60B30-02S08	●	2	0°	4.09	8.56	12.7	5.6	S08	23	KEYV-S08	15	2
VDP509L6.89B30-02S12	●	2	0°	5.09	10.69	18.45	6.9	S12	25.5	KEYV-S12	28	2
VDP641L8.63B30-02S12	●	2	0°	6.41	13.29	20	8.6	S12	25.5	KEYV-S12	28	2

Torque*: Recommended clamping torque (N-m)
2 pieces per package

● : Line up

STANDARD CUTTING CONDITIONS

Center drill

VDP

ISO	Workpiece material	Hardness	Cutting speed Vc (m/min)	Feed : f (mm/rev)						
				VDP107	VDP165	VDP2	VDP3	VDP4	VDP5	VDP6
P	Carbon steel S45C, S55C, etc. C45, C55, etc.	- 300 HB	40 - 80	0.02 - 0.04	0.025 - 0.05	0.025 - 0.05	0.04 - 0.08	0.05 - 0.1	0.05 - 0.1	0.06 - 0.12
	Alloy steel SCM440, SCr420, etc. 42CrMo4, 20Cr4, etc.	- 300 HB	30 - 50	0.02 - 0.04	0.025 - 0.05	0.025 - 0.05	0.04 - 0.08	0.05 - 0.1	0.05 - 0.1	0.06 - 0.12
	Prehardened steel PX5, NAK80, etc.	30 - 40 HRC	20 - 30	0.02 - 0.04	0.025 - 0.05	0.025 - 0.05	0.04 - 0.08	0.05 - 0.1	0.05 - 0.1	0.06 - 0.12
M	Stainless steel SUS304, SUS316, etc. X5CrNi18-9, X5CrNiMo17-12-2, etc.	- 200 HB	15 - 25	0.015 - 0.03	0.02 - 0.04	0.02 - 0.04	0.04 - 0.08	0.05 - 0.1	0.05 - 0.1	0.06 - 0.12
K	Grey cast iron FC250, FC300, etc. 250, 300, etc., GG250, GG300, etc.	150 - 250 HB	60 - 100	0.02 - 0.04	0.025 - 0.05	0.025 - 0.05	0.05 - 0.09	0.07 - 0.12	0.07 - 0.12	0.12 - 0.18
	Ductile cast iron FCD450, etc. 450-10S, etc., GGG450, etc.	150 - 250 HB	60 - 100	0.02 - 0.04	0.025 - 0.05	0.025 - 0.05	0.04 - 0.08	0.05 - 0.1	0.05 - 0.1	0.1 - 0.15
S	Titanium alloys Ti-6Al-4V, etc.	- 40 HRC	15 - 25	0.01 - 0.02	0.01 - 0.02	0.015 - 0.03	0.04 - 0.07	0.04 - 0.07	0.04 - 0.07	0.04 - 0.07
	Heat-resistant alloys Inconel 718, etc.	- 40 HRC	10 - 20	0.01 - 0.02	0.01 - 0.02	0.015 - 0.03	0.03 - 0.06	0.03 - 0.06	0.03 - 0.06	0.03 - 0.06
H	Hardened steel SKD61, SKT4, etc. 55NiCrMoV7, etc.	40 - 50 HRC	15 - 25	-	-	-	0.04 - 0.07	0.04 - 0.07	0.04 - 0.07	0.04 - 0.07
	Hardened steel SKD11, SKH51, etc. HS6-5-2, etc.	50 - 60 HRC	10 - 20	-	-	-	0.03 - 0.06	0.03 - 0.06	0.03 - 0.06	0.03 - 0.06

2 flute, for counterboring (can be used for milling)

Counterboring

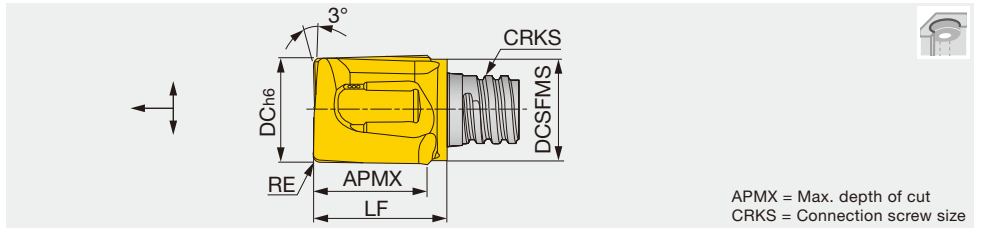

Designation	AH725	NOF	FHA	DC	DCSFMS	APMX	RE	CRKS	LF	Wrench	Torque*
VGC078L08.0R02-02S05	●	2	10°	7.8	7.6	8	0.2	S05	10	KEYV-S05	7
VGC080L08.0R04-02S05	●	2	10°	8	7.6	8	0.4	S05	10	KEYV-S05	7
VGC080L08.0R10-02S05	●	2	10°	8	7.6	8	1	S05	10	KEYV-S05	7
VGC080L08.0R20-02S05	●	2	10°	8	7.6	8	2	S05	10	KEYV-S05	7
VGC098L09.0R03-02S06	●	2	10°	9.8	9.5	9.5	0.3	S06	12.4	KEYV-S06	10
VGC100L09.0R04-02S06	●	2	10°	10	9.5	9.5	0.4	S06	12.4	KEYV-S06	10
VGC100L09.0R10-02S06	●	2	10°	10	9.5	9.5	1	S06	12.4	KEYV-S06	10
VGC100L09.0R20-02S06	●	2	10°	10	9.5	9.5	2	S06	12.4	KEYV-S06	10
VGC120L10.0R04-02S08	●	2	10°	12	11.5	10	0.4	S08	14.2	KEYV-S08	15
VGC120L10.0R10-02S08	●	2	10°	12	11.5	10	1	S08	14.2	KEYV-S08	15
VGC120L10.0R20-02S08	●	2	10°	12	11.5	10	2	S08	14.2	KEYV-S08	15
VGC160L15.0R04-02S10	●	2	10°	16	15.2	15	0.4	S10	19	KEYV-S10	28
VGC160L15.0R08-02S10	●	2	10°	16	15.2	15	0.8	S10	19	KEYV-S10	28

Can drill with step feed (Maximum depth: ap x 0.5)
Torque*: Recommended clamping torque (N·m)
2 pieces per package

● : Line up

STANDARD CUTTING CONDITIONS

Counterboring

VGC

ISO	Workpiece material	Hardness	Cutting speed Vc (m/min)	Feed per tooth fz (mm/t)
P	Carbon steel S45C, S55C, etc. C45, C55, etc.	- 300 HB	40 - 80	0.04 - 0.08
	Alloy steel SCM440, SCr420, etc. 42CrMo4, 20Cr4, etc.	- 300 HB	30 - 50	0.04 - 0.08
	Prehardened steel PX5, NAK80, etc.	30 - 40 HRC	20 - 30	0.04 - 0.08
M	Stainless steel SUS304, SUS316, etc. X5CrNi18-9, X5CrNiMo17-12-2, etc.	- 200 HB	15 - 25	0.04 - 0.08
K	Grey cast iron FC250, FC300, etc. 250, 300, etc., GG250, GG300, etc.	150 - 250 HB	60 - 100	0.05 - 0.09
	Ductile cast iron FCD450, etc. 450-10S, etc., GGG450, etc.	150 - 250 HB	60 - 100	0.04 - 0.08
S	Titanium alloys Ti-6Al-4V, etc.	- 40 HRC	15 - 25	0.04 - 0.07
	Heat-resistant alloys Inconel 718, etc.	- 40 HRC	10 - 20	0.03 - 0.06
H	Hardened steel SKD61, SKT4, etc. 55NiCrMoV7, etc.	40 - 50 HRC	15 - 25	0.04 - 0.07
	Hardened steel SKD11, SKH51, etc. HS6-5-2, etc.	50 - 60 HRC	10 - 20	0.03 - 0.06

When drilling, pecking operation should be applied with the depth of 0.3 - 0.5 mm per step.
Apply the same cutting conditions as the VEE type head when conducting shoulder milling or slotting operations.



3 flute, for slotting



Slotting

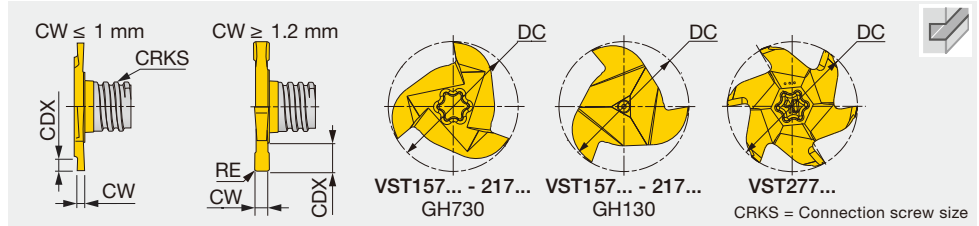

Designation	GH730	AH735	GH130	NOF	FHA	DC	CW±0.02	RE	CRKS	CDX	Wrench	Torque*
VST157W1.50R010-3S06	●		▲	3	0°	15.7	1.5	0.1	S06	2.8	KEYV-177 ⁽²⁾ / KEYV-T20 ⁽³⁾	10
VST157W1.57R020-3S06	●		▲	3	0°	15.7	1.57	0.2	S06	2.8	KEYV-177 ⁽²⁾ / KEYV-T20 ⁽³⁾	10
VST157W2.00R020-3S06	●		▲	3	0°	15.7	2	0.2	S06	2.8	KEYV-177 ⁽²⁾ / KEYV-T20 ⁽³⁾	10
VST157W2.39R020-3S06	●		▲	3	0°	15.7	2.39	0.2	S06	2.8	KEYV-177 ⁽²⁾ / KEYV-T20 ⁽³⁾	10
VST157W2.50R020-3S06	●		▲	3	0°	15.7	2.5	0.2	S06	2.8	KEYV-177 ⁽²⁾ / KEYV-T20 ⁽³⁾	10
VST157W3.00R020-3S06	●		▲	3	0°	15.7	3	0.2	S06	2.8	KEYV-177 ⁽²⁾ / KEYV-T25 ⁽³⁾	10
VST157W3.17R020-3S06	●		▲	3	0°	15.7	3.17	0.2	S06	2.8	KEYV-177	10
VST177W1.20R005-3S06	●		▲	3	0°	17.7	1.2 ⁽¹⁾	0.05	S06	3.8	KEYV-177 ⁽²⁾ / KEYV-T20 ⁽³⁾	10
VST177W1.40R005-3S06	●		▲	3	0°	17.7	1.4 ⁽¹⁾	0.05	S06	3.8	KEYV-177 ⁽²⁾ / KEYV-T20 ⁽³⁾	10
VST177W1.50R010-3S06	●		▲	3	0°	17.7	1.5	0.1	S06	3.8	KEYV-177 ⁽²⁾ / KEYV-T20 ⁽³⁾	10
VST177W1.57R020-3S06	●		▲	3	0°	17.7	1.57	0.2	S06	3.8	KEYV-177 ⁽²⁾ / KEYV-T20 ⁽³⁾	10
VST177W1.70R005-3S06	●		▲	3	0°	17.7	1.7 ⁽¹⁾	0.05	S06	3.8	KEYV-177 ⁽²⁾ / KEYV-T20 ⁽³⁾	10
VST177W2.00R020-3S06	●		▲	3	0°	17.7	2	0.2	S06	3.8	KEYV-177 ⁽²⁾ / KEYV-T20 ⁽³⁾	10
VST177W2.20R110-3S06			▲	3	0°	17.7	2.20	1.1	S06	3.8	KEYV-177	10
VST177W2.39R020-3S06			▲	3	0°	17.7	2.39	0.2	S06	3.8	KEYV-177	10
VST177W2.50R020-3S06	●		▲	3	0°	17.7	2.5	0.2	S06	3.8	KEYV-177 ⁽²⁾ / KEYV-T20 ⁽³⁾	10
VST177W3.00R020-3S06	●	▲	▲	3	0°	17.7	3	0.2	S06	3.8	KEYV-177 ⁽²⁾ / KEYV-T25 ⁽³⁾	10
VST177W3.17R020-3S06			▲	3	0°	17.7	3.17	0.2	S06	3.8	KEYV-177	10

(1) CW is based on DIN471 / 472

(2) Applicable for GH130, AH735

(3) Applicable for GH730

Torque*: Recommended clamping torque (N·m)

2 pieces per package

● : Line up

▲ : To be discontinued

VST**-4/6...

4, 6 flute, for slotting

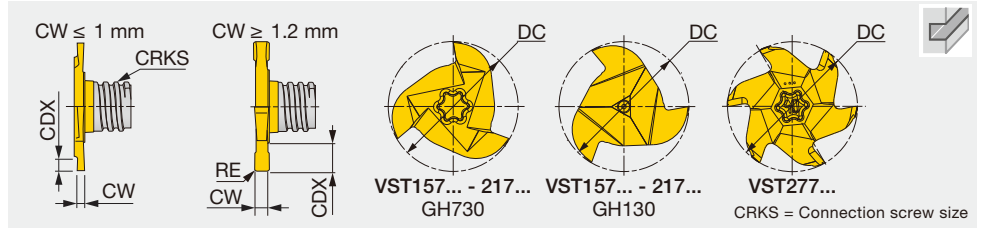
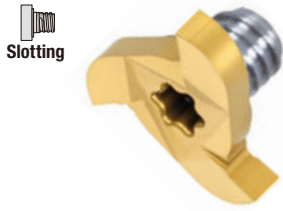

Designation	GH730	AH735	GH130	NOF	FHA	DC	CW±0.02	RE	CRKS	CDX	Wrench	Torque*
VST217W0.76R000-4S08	●		▲	4	0°	21.7	0.76 ⁽¹⁾	-	S08	1.5	KEYV-217 ⁽²⁾ / KEYV-T25 ⁽³⁾	15
VST217W0.86R000-4S08			▲	4	0°	21.7	0.86 ⁽¹⁾	-	S08	1.7	KEYV-217	15
VST217W0.96R000-4S08	●		▲	4	0°	21.7	0.96 ⁽¹⁾	-	S08	1.9	KEYV-217 ⁽²⁾ / KEYV-T25 ⁽³⁾	15
VST217W1.00R005-4S08	●		▲	4	0°	21.7	1	0.05	S08	2	KEYV-217 ⁽²⁾ / KEYV-T25 ⁽³⁾	15
VST217W1.20R005-4S08	●		▲	4	0°	21.7	1.2 ⁽¹⁾	0.05	S08	4.5	KEYV-217 ⁽²⁾ / KEYV-T25 ⁽³⁾	15
VST217W1.40R005-4S08	●		▲	4	0°	21.7	1.4 ⁽¹⁾	0.05	S08	4.5	KEYV-217 ⁽²⁾ / KEYV-T25 ⁽³⁾	15
VST217W1.57R000-4S08	●		▲	4	0°	21.7	1.57	-	S08	4.5	KEYV-217 ⁽²⁾ / KEYV-T25 ⁽³⁾	15
VST217W1.70R010-4S08	●		▲	4	0°	21.7	1.7 ⁽¹⁾	0.1	S08	4.5	KEYV-217 ⁽²⁾ / KEYV-T25 ⁽³⁾	15
VST217W1.95R020-4S08	●		▲	4	0°	21.7	1.95 ⁽¹⁾	0.2	S08	4.5	KEYV-217 ⁽²⁾ / KEYV-T25 ⁽³⁾	15
VST217W2.00R020-4S08	●		▲	4	0°	21.7	2	0.2	S08	4.5	KEYV-217 ⁽²⁾ / KEYV-T25 ⁽³⁾	15
VST217W2.25R020-4S08	●		▲	4	0°	21.7	2.25 ⁽¹⁾	0.2	S08	4.5	KEYV-217 ⁽²⁾ / KEYV-T25 ⁽³⁾	15
VST217W2.39R020-4S08	●		▲	4	0°	21.7	2.39	0.2	S08	4.5	KEYV-217 ⁽²⁾ / KEYV-T25 ⁽³⁾	15
VST217W2.50R020-4S08	●	▲	▲	4	0°	21.7	2.5	0.2	S08	4.5	KEYV-217 ⁽²⁾ / KEYV-T25 ⁽³⁾	15
VST217W2.75R020-4S08	●		▲	4	0°	21.7	2.75 ⁽¹⁾	0.2	S08	4.5	KEYV-217 ⁽²⁾ / KEYV-T25 ⁽³⁾	15
VST217W3.00R020-4S08	●	▲	▲	4	0°	21.7	3	0.2	S08	4.5	KEYV-217 ⁽²⁾ / KEYV-T30L ⁽³⁾	15
VST217W3.17R020-4S08	●		▲	4	0°	21.7	3.17	0.2	S08	4.5	KEYV-217 ⁽²⁾ / KEYV-T30L ⁽³⁾	15
VST217W3.25R020-4S08	●		▲	4	0°	21.7	3.25 ⁽¹⁾	0.2	S08	4.5	KEYV-217 ⁽²⁾ / KEYV-T30L ⁽³⁾	15
VST217W4.00R020-4S08	●		▲	4	0°	21.7	4	0.2	S08	4.5	KEYV-217 ⁽²⁾ / KEYV-T30L ⁽³⁾	15
VST217W4.25R020-4S08	●		▲	4	0°	21.7	4.25 ⁽¹⁾	0.2	S08	4.5	KEYV-217 ⁽²⁾ / KEYV-T30L ⁽³⁾	15
VST217W4.75R020-4S08	●		▲	4	0°	21.7	4.75	0.2	S08	4.5	KEYV-217 ⁽²⁾ / KEYV-T30L ⁽³⁾	15
VST217W5.25R020-4S08	●		▲	4	0°	21.7	5.25 ⁽¹⁾	0.2	S08	4.5	KEYV-217 ⁽²⁾ / KEYV-T30L ⁽³⁾	15
VST277W2.50R020-6S10	●		▲	6	0°	27.7	2.5	0.2	S10	6	KEYV-T40L	28
VST277W5.25R020-6S10	●		▲	6	0°	27.7	5.25 ⁽¹⁾	0.2	S10	6	KEYV-T40L	28
VST277W10.0R020-6S10	●		▲	6	0°	27.7	10	0.2	S10	6	KEYV-T40L	28

(1) CW is based on DIN471 / 472

(2) Applicable for GH130, AH735

(3) Applicable for GH730

Torque*: Recommended clamping torque (N·m)

2 pieces per package

● : Line up
▲ : To be discontinued

VST**A45...

3, 4 flute, for slotting with 45° chamfer

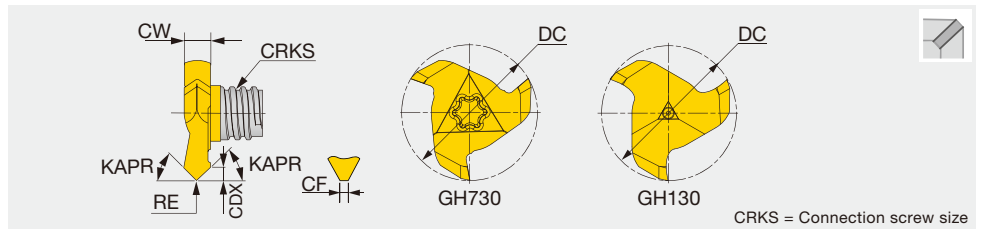

Designation	GH730	GH130	NOF	FHA	DC	CW	KAPR	CRKS	CDX	CF	RE	Wrench	Torque*
VST177L01.40A45-3S06	●	▲	3	0°	17.7	3.4	45°	S06	1.4	-	0.1	KEYV-177 ⁽¹⁾ / KEYV-T25 ⁽²⁾	10
VST217L01.70A45-4S08	●	▲	4	0°	21.7	5.5	45°	S08	1.7	1.5	-	KEYV-217 ⁽¹⁾ / KEYV-T30L ⁽²⁾	15

(1) Applicable for GH130

(2) Applicable for GH730

Torque*: Recommended clamping torque (N·m)

2 pieces per package

● : Line up
▲ : To be discontinued

Reference pages: Standard cutting conditions → I095



6 flute, for T-slotting



Slotting

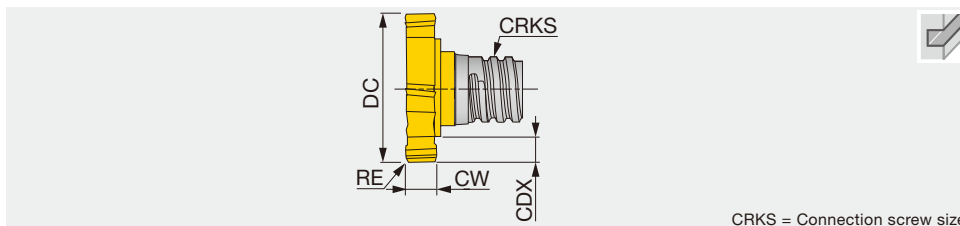

CRKS = Connection screw size

Designation	GH730	AH735	GH130	NOF	FHA	DC -0.05	CW ± 0.02	CDX	CRKS	RE	Wrench	Torque*
VTB135W3.00R04-06S05	●		▲	6	0°	13.5	3	2.65	S05	0.4	KEYV-T20	7
VTB135W4.00R04-06S05	●		▲	6	0°	13.5	4	2.65	S05	0.4	KEYV-T20	7
VTB160W2.00R04-06S06	●		▲	6	0°	16	2	2.9	S06	0.4	KEYV-T20	10
VTB160W3.00R04-06S06	●		▲	6	0°	16	3	2.9	S06	0.4	KEYV-T25	10
VTB160W4.00R04-06S06	●		▲	6	0°	16	4	2.9	S06	0.4	KEYV-T25	10
VTB165W2.00R04-06S06	●		▲	6	0°	16.5	2	3.15	S06	0.4	KEYV-T20	10
VTB165W3.00R04-06S06	●		▲	6	0°	16.5	3	3.15	S06	0.4	KEYV-T25	10
VTB165W4.00R04-06S06	●		▲	6	0°	16.5	4	3.15	S06	0.4	KEYV-T25	10
VTB195W4.00R04-06S08	●		▲	6	0°	19.5	4	3.45	S08	0.4	KEYV-T30L	15
VTB195W5.00R04-06S08	●		▲	6	0°	19.5	5	3.45	S08	0.4	KEYV-T30L	15
VTB195W6.00R04-06S08	●		▲	6	0°	19.5	6	3.45	S08	0.4	KEYV-T30L	15
VTB225W5.00R04-06S08	●		▲	6	0°	22.5	5	4.95	S08	0.4	KEYV-T40L	15
VTB225W6.00R04-06S08	●		▲	6	0°	22.5	6	4.95	S08	0.4	KEYV-T40L	15
VTB225W8.00R04-06S08	●		▲	6	0°	22.5	8	4.95	S08	0.4	KEYV-T40L	15
VTB250W6.00R04-06S08	●		▲	6	0°	25	6	5.9	S08	0.4	KEYV-T50L	15
VTB250W8.00R04-06S08	●		▲	6	0°	25	8	5.9	S08	0.4	KEYV-T50L	15
VTB250W5.00R04-06S10	●		▲	6	0°	25	5	4.3	S10	0.4	KEYV-T50L	28
VTB250W6.00R04-06S10		▲	▲	6	0°	25	6	4.3	S10	0.4	KEYV-T50L	28
VTB250W8.00R04-06S10	●		▲	6	0°	25	8	4.3	S10	0.4	KEYV-T50L	28

Torque*: Recommended clamping torque (N·m)
2 pieces per package● : Line up
▲ : To be discontinued

VTB**C15-06...

6 flute, for T-slotting with 45° chamfer



Slotting

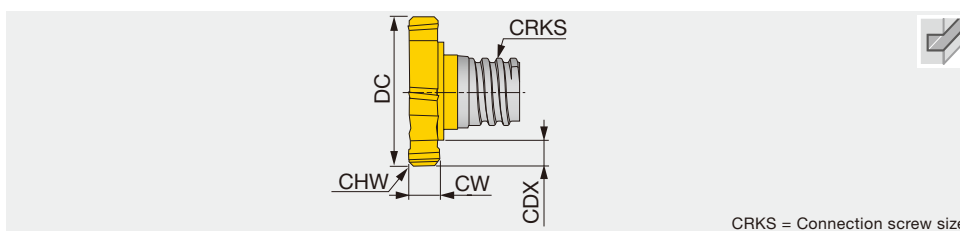

CRKS = Connection screw size

Designation	GH730	GH130	NOF	FHA	DC -0.05	CW ± 0.02	CDX	CRKS	CHW	Wrench	Torque*
VTB135W2.00C15-06S05	●	▲	6	0°	13.5	2	2.65	S05	0.15	KEYV-T20	7

Torque*: Recommended clamping torque (N·m)
2 pieces per package● : Line up
▲ : To be discontinued

Reference pages: Standard cutting conditions → I095

STANDARD CUTTING CONDITIONS

Slotting

VST, VTB

ISO	Workpiece material	Hardness	VST		VTB	
			Cutting speed Vc (m/min)	Feed per tooth fz (mm/t)	Cutting speed Vc (m/min)	Feed per tooth fz (mm/t)
P	Carbon steel S45C, S55C, etc. C45, C55, etc.	- 300 HB	80 - 180	0.05 - 0.15	80 - 180	0.08 - 0.18
	Alloy steel SCM440, SCr420, etc. 42CrMo4, 20Cr4, etc.	- 300 HB	60 - 120	0.04 - 0.12	60 - 120	0.05 - 0.15
M	Stainless steel SUS304, SUS316, etc. X5CrNi18-9, X5CrNiMo17-12-2, etc.	- 200 HB	50 - 120	0.04 - 0.12	50 - 120	0.05 - 0.15
K	Grey cast iron FC250, FC300, etc. 250, 300, etc., GG250, GG300, etc.	150 - 250 HB	100 - 200	0.05 - 0.15	100 - 200	0.08 - 0.18
	Ductile cast iron FCD450, etc. 450-10S, etc., GGG450, etc.	150 - 250 HB	100 - 200	0.04 - 0.12	100 - 200	0.05 - 0.15
N	Aluminium alloys Si < 13%	-	200 - 600	0.05 - 0.15	200 - 600	0.08 - 0.18
	Aluminium alloys Si ≥ 13%	-	100 - 300	0.03 - 0.13	100 - 300	0.05 - 0.15
S	Titanium alloys Ti-6Al-4V, etc.	- 40 HRC	40 - 60	0.04 - 0.12	40 - 60	0.05 - 0.15
	Heat-resistant alloys Inconel 718, etc.	- 40 HRC	15 - 35	0.02 - 0.1	15 - 35	0.02 - 0.1

Tolerance of tool diameter

Basic dimensions (mm)		Permissible dimensional deviations (µm)						
>	≤	e8	e9	h6	h7	h9	h10	z9
6	10	-25 -47	-25 -61	0 -9	0 -15	0 -36	0 -58	+78 +42
10	14	-32 -59	-32 -75	0 -11	0 -18	0 -43	0 -70	+93 +50
14	18	-32 -59	-32 -75	0 -11	0 -18	0 -43	0 -70	+103 +60
18	30	-40 -73	-40 -92	0 -13	0 -21	0 -52	0 -84	-

JISB0401-2: 1998 (ISO286-2: 1988) extract

Grade
Insert
Ext. Toolholder
Int. Toolholder
Threading
Grooving
Miniature tool
Milling cutter
Endmill
Drilling tool
Tooling System
User's Guide
Index



ISO metric (M)

VMT***IS

3 - 6 flute, full profile, for internal thread



Threading

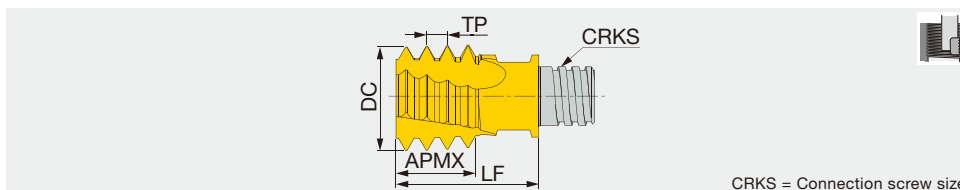

CRKS = Connection screw size

Designation	AH725	TP	Application range	DC	NOF	APMX	LF	CRKS	Wrench	Torque*
VMT100L06IS07-4S05	●	0.75	≥ M12	10	4	6	12.8	S05	KEYV-S05	7
VMT100L06IS10-4S05	●	1	≥ M12	10	4	6	12.8	S05	KEYV-S05	7
VMT100L06IS15-4S05	●	1.5	≥ M13	10	4	6	12.8	S05	KEYV-S05	7
VMT120L08IS15-4S06	●	1.5	≥ M16	12	4	7.6	14.3	S06	KEYV-S06	10
VMT120L08IS20-4S06	●	2	≥ M16	12	4	8	14.3	S06	KEYV-S06	10
VMT160L12IS15-6S08	●	1.5	≥ M20	16	6	12	19	S08	KEYV-T30L	15
VMT160L12IS20-5S08	●	2	≥ M19	16	5	12	19	S08	KEYV-T30L	15
VMT154L13IS25-5S08	●	2.5	≥ M20	15.4	5	12.7	20	S08	KEYV-S08	15
VMT160L12IS30-3S08	●	3	≥ M20	16	3	12	19	S08	KEYV-T30L	15

Torque*: Recommended clamping torque (N-m)
2 pieces per package

● : Line up

Unified (UN, UNC, UNF, UNEF, UNS)

VMT***UN

3, 4, 5 flute, full profile, for internal thread



Threading

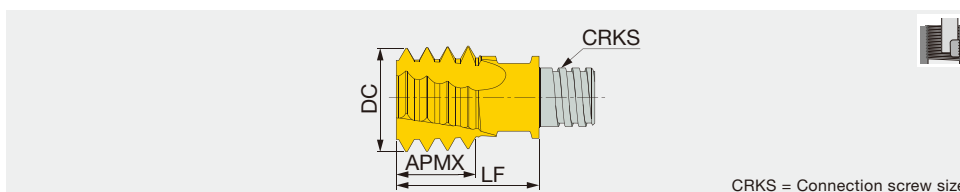

CRKS = Connection screw size

Designation	AH725	TPI	Application range	DC	NOF	APMX	LF	CRKS	Wrench	Torque*
VMT100L06UN24-4S05	●	24	≥ 1/2	10	4	5.3	12.8	S05	KEYV-S05	7
VMT100L06UN20-4S05	●	20	≥ 1/2	10	4	5.1	12.8	S05	KEYV-S05	7
VMT120L08UN16-4S06	●	16	≥ 5/8	12	4	8	14.3	S06	KEYV-S06	10
VMT120L10UN14-4S06	●	14	≥ 5/8	12	4	9	14.3	S06	KEYV-T25	10
VMT160L13UN12-5S08	●	12	≥ 13/16	16	5	12.7	19	S08	KEYV-T30L	15
VMT150L13UN10-4S08	●	10	≥ 3/4	15.4	4	12.7	19	S08	KEYV-T30L	15
VMT160L11UN09-3S08	●	9	≥ 7/8	16	3	11.3	19	S08	KEYV-T30L	15
VMT160L13UN08-3S08	●	8	≥ 15/16	16	3	12.7	20	S08	KEYV-S08	15

Torque*: Recommended clamping torque (N-m)
2 pieces per package

● : Line up

Reference pages: Standard cutting conditions → [I098](#)

Whitworth (G, Rp, BSP, PF, PS)

VMT***W

4 flute, full profile, for internal/external thread

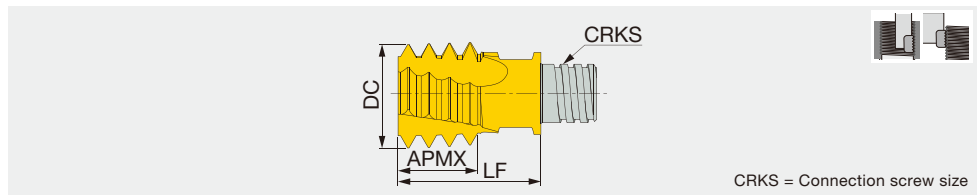

CRKS = Connection screw size

Designation	AH725	TPI	Application range	DC	NOF	APMX	LF	CRKS	Wrench	Torque*
VMT100L06W19-4S05	●	19	1/4, 3/8	10	4	5.3	12.8	S05	KEYV-S05	7
VMT160L13W14-4S08	●	14	1/2, 5/8, 3/4, 7/8	16	4	12.7	20	S08	KEYV-S08	15
VMT160L11W11-4S08	●	11	≥1	16	4	11.6	19	S08	KEYV-T30L	15

Torque*: Recommended clamping torque (N-m)
2 pieces per package

● : Line up

60° partial profile

VTR***IS

3, 4 flute, partial profile, for internal/external thread

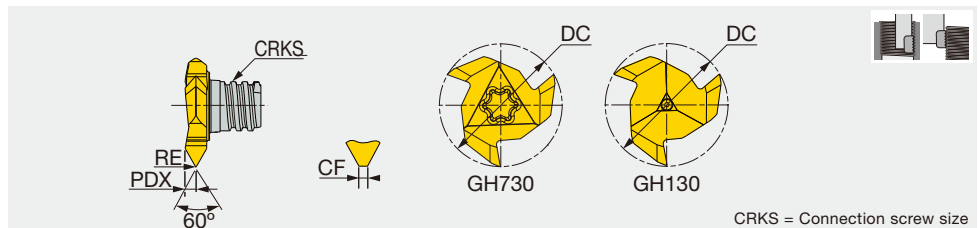

CRKS = Connection screw size

Designation	GH730	GH130	TP		Smallest Possible thread	DC	NOF	RE	CF	PDX	CRKS	Wrench	Torque*
			TPN	TPX									
VTR160L12IS05-3S06	●	▲	0.5	2	M20	15.7	3	-	0.05	1.4	S06	KEYV-177 ⁽¹⁾ / KEYV-T25 ⁽²⁾	10
VTR160L12IS15-3S06	●	▲	1.5	2	M22	15.7	3	0.05	-	1.4	S06	KEYV-177 ⁽¹⁾ / KEYV-T25 ⁽²⁾	10
VTR220L28IS30-4S08	●	▲	3	4.5	M36	21.7	4	0.2	-	2.8	S08	KEYV-217 ⁽¹⁾ / KEYV-T30L ⁽²⁾	15

(1) Applicable for GH130
(2) Applicable for GH730
Torque*: Recommended clamping torque (N-m)
2 pieces per package

● : Line up
▲ : To be discontinued

55° partial profile

VTR***W

4 flute, partial profile, for internal/external thread

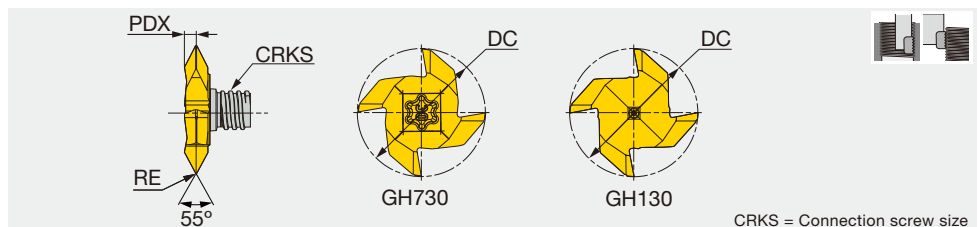
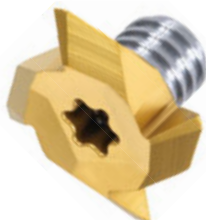

CRKS = Connection screw size

Designation	GH730	GH130	TPI		Smallest Possible thread	DC	NOF	RE	PDX	CRKS	Wrench	Torque*
			TPIN	TPIX								
VTR220L24W14-4S08	●	▲	14	11	3/4	21.7	4	0.2	2.4	S08	KEYV-217 ⁽¹⁾ / KEYV-T30L ⁽²⁾	15

(1) Applicable for GH130
(2) Applicable for GH730
Torque*: Recommended clamping torque (N-m)
2 pieces per package

● : Line up
▲ : To be discontinued

Reference pages: Standard cutting conditions → [I098](#)

STANDARD CUTTING CONDITIONS

Threading

VMT, VTR

ISO	Material	Condition	Tensile strength [N/mm ²]	Hardness	Cutting speed Vc (m/min)	Tool dia. : DC (mm)				
						Feed per tooth: fz (mm/t)				
						ø10	ø12	ø15.4, ø15.7, ø16	ø21.7	
P	Non-alloy steel and cast steel, free cutting steel	< 0.25 %C	Annealed	420	125 HB	100 - 250	0.08	0.09	0.12	0.15
		≥ 0.25 %C	Annealed	650	190 HB	80 - 210	0.08	0.09	0.12	0.15
		< 0.55 %C	Quenched and tempered	850	250 HB	65 - 170				
		≥ 0.55 %C	Annealed	750	220 HB	110 - 180	0.07	0.08	0.1	0.12
	Low alloy steel and cast steel (less than 5% of alloying elements)	Quenched and tempered		1000	300 HB	95 - 160	0.07	0.08	0.1	0.12
			Annealed	600	200 HB	90 - 160	0.05	0.05	0.07	0.08
		Quenched and tempered		930	275 HB	65 - 200	0.05	0.05	0.07	0.08
				1000	300 HB	70 - 210	0.05	0.05	0.07	0.08
		High alloyed steel, cast steel, and tool steel	Annealed	680	200 HB	130 - 170	0.05	0.05	0.07	0.08
			Quenched and tempered	1100	325 HB	75 - 100	0.05	0.05	0.07	0.08
	Stainless steel and cast steel	Ferritic/martensitic	680	200 HB	110 - 170	0.05	0.05	0.07	0.08	
		Martensitic	820	240 HB	70 - 155	0.05	0.05	0.07	0.08	
M	Stainless steel	Annealed	600	180 HB	85 - 100	0.05	0.05	0.07	0.08	
K	Cast iron nodular (GGG)	Ferritic/martensitic		180 HB	120 - 160	0.08	0.09	0.12	0.15	
		Pearlitic		260 HB	75 - 160	0.08	0.09	0.12	0.15	
	Grey cast iron (GG)	Ferritic		160 HB	70 - 150	0.08	0.09	0.12	0.15	
		Pearlitic		250 HB	110 - 140	0.08	0.09	0.12	0.15	
	Malleable cast iron	Ferritic		130 HB	120 - 160	0.08	0.09	0.12	0.15	
		Pearlitic		230 HB	110 - 140	0.08	0.09	0.21	0.15	
N	Aluminium-wrought alloy	Not cureable		60 HB	160 - 300	0.08	0.09	0.12	0.15	
		Cured		100 HB						
	Aluminium-cast, alloyed	≤12% Si	Not cureable		75 HB	150 - 350	0.08	0.09	0.12	0.15
		>12% Si	High temperature		130 HB	100 - 250	0.05	0.05	0.07	0.08
	Copper alloys	>1% Pb	Free cutting		110 HB					
			Brass		90 HB					
	Non-metallic		Duroplastics, fiber plastics			100 - 400	0.11	0.12	0.15	0.18
			Hard rubber							
	S	High temp. alloys	Fe based	Annealed		200 HB				
				Cured		280 HB				
Ni or Co based			Annealed		250 HB	20 - 80	0.03	0.03	0.04	0.04
			Cured		350 HB					
Titanium Ti alloys				RM 400						
		Alpha+beta alloys cured		RM 1050	20 - 80	0.03	0.03	0.04	0.04	
H	Hardened steel	Hardened		55 HRC	55 - 65					
		Hardened		60 HRC	45 - 55					
	Chilled cast iron	Cast		400 HB	90 - 105					
	Cast iron	Hardened		55 HRC	55 - 65					

Thread Milling CNC Program for Internal Thread

Right-hand thread (climb milling) from bottom up. Program is based on tool center.
This method of programming needs no tool radius compensation value, other than an offset for wear.

General Program

```
G90 G00 G54 G43 H1X0 Y0 Z10 S (n : Number of revolutions)
G00 Z-(to thread depth)
G01 G91 G41 D1 X (A/2) Y-(A/2) Z0 F (Center of tool)
G03 X(A/2) Y(A/2) R (A/2) Z(1/8 pitch) F (Cutting edge)
G03 X0 Y0 I -(A) J0 Z (pitch)
G03 X-(A/2) Y(A/2) R (A/2) Z(1/8 pitch)
G01 G40 X -(A/2) Y-(A/2) Z0
G90 X0 Y0 Z0
```

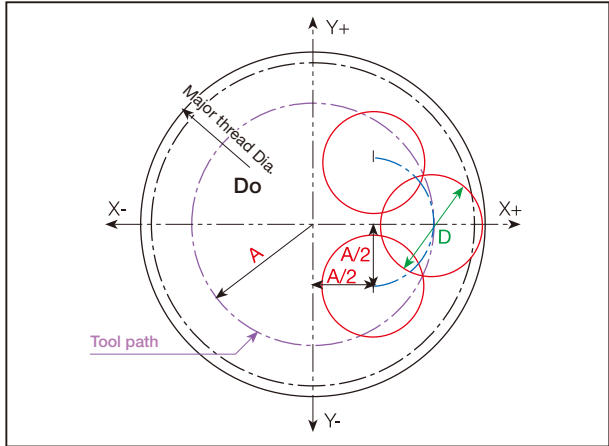

$$A = \frac{D_o - D}{2}$$

A = Radius of tool path
Do = Major thread diameter
D = Cutting diameter

F (Center of tool) = $n \times f \times z$ n : Number of revolutions
F (Cutting edge) = $\frac{D_o - D}{D_o} \times n \times f \times z$ f : rev / tooth
z : Number of edge

Internal Thread

Example: M20x2.0 IN-RH (Thread depth 20 mm)

Tool : MTEC1010C27 2.0ISO

(Cutting dia. 10 mm)

$$A = (D_o - D) / 2 = (20 - 10) / 2 = 5$$

$$A/2 = 2.5$$

(Tool compensation of radius=0)

```
G90 G0 G54 G43 G17 H1X0 Y0 Z10 S4000
G0 Z-20
G01 G91 G41 D1X 2.5 Y-2.5 Z0 F840
G03 X2.5 Y2.5 R2.5 Z0.25 F420
G03 X0 Y0 I-5.0 J0 Z2.0
G03 X-2.5 Y2.5 R2.5 Z0.25
G01 G40 X-2.5 Y-2.5 Z0
G90 G0 X0 Y0 Z0
M30
%
```

Machining procedure

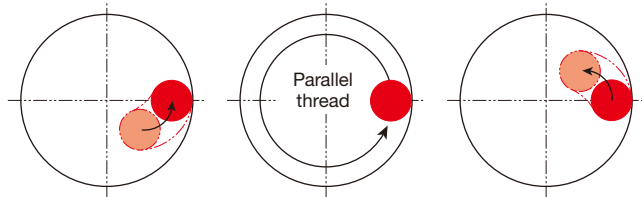

(a) Tool approach (b) Machining thread (c) Tool retraction

Internal Thread

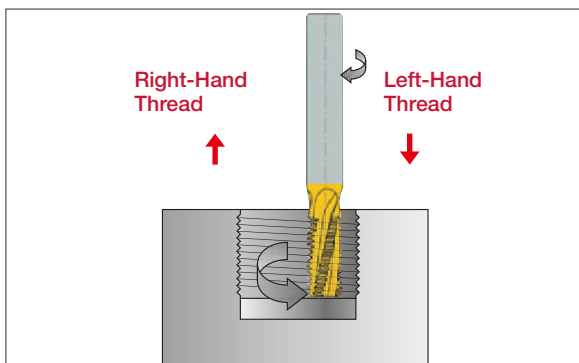

External Thread

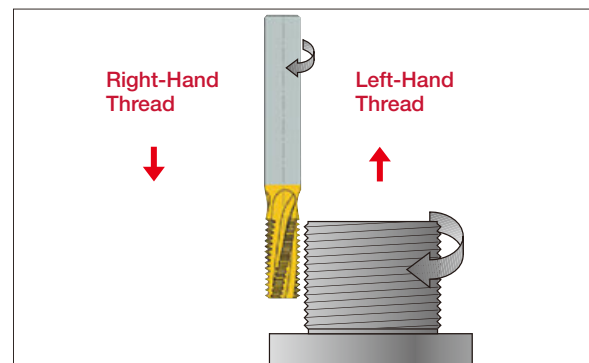

A thread milling operation is applicable for thread cutting in non-symmetrical parts utilizing the advantage of helical interpolation programs on modern machining centers.



For more details, please check ThreadMilling advisor.

Straight shank and neck with coolant hole

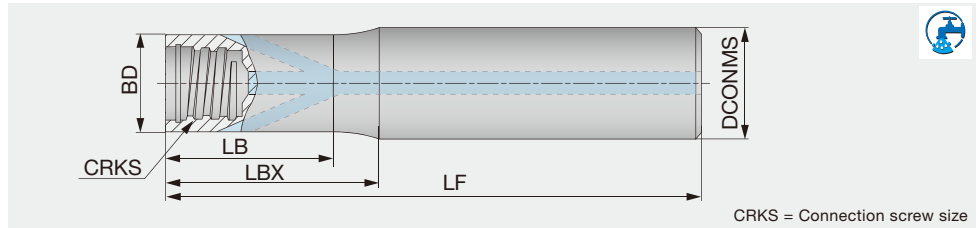

CRKS = Connection screw size

Designation	DCONMS	BD	LF	LBX	LB	CRKS	Shank material
VSSD10L070S06-W-A	10	9.6	70	20	19	S06	Tungsten
VSSD10L090S06-W-A	10	9.6	90	40	39	S06	Tungsten
VSSD10L110S06-W-A	10	9.6	110	60	59	S06	Tungsten
VSSD12L070S08-W-A	12	11.5	70	20	19	S08	Tungsten
VSSD12L090S08-W-A	12	11.5	90	40	39	S08	Tungsten
VSSD12L110S08-W-A	12	11.5	110	60	59	S08	Tungsten
VSSD12L130S08-W-A	12	11.5	130	80	79	S08	Tungsten
VSSD16L070S10-W-A	16	15.2	70	20	18.5	S10	Tungsten
VSSD16L090S10-W-A	16	15.2	90	40	36.5	S10	Tungsten
VSSD16L110S10-W-A	16	15.2	110	60	58.5	S10	Tungsten
VSSD16L130S10-W-A	16	15.2	130	80	78.5	S10	Tungsten
VSSD20L090S12-W-A	20	18.3	90	40	37	S12	Tungsten
VSSD20L130S12-W-A	20	18.3	130	80	77	S12	Tungsten



Others

VSSD...

High rigidity shank

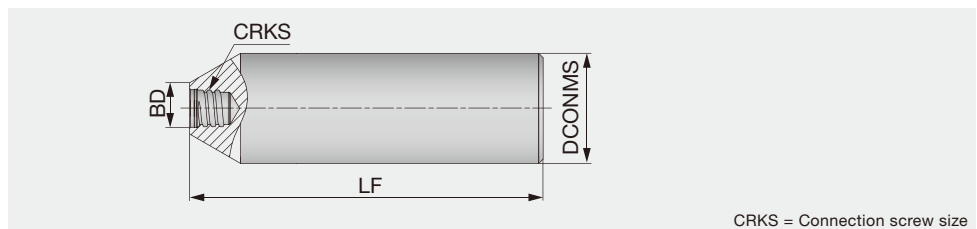

CRKS = Connection screw size

Designation	DCONMS	BD	LF	CRKS	Shank shape	Shank material
VSSD06L050S04-S	6	5.8	50	S04	Cylindrical	Steel
VSSD06L060S04-C	6	5.8	60	S04	Cylindrical	Carbide
VSSD08L050S04-S	8	5.8	50	S04	Cylindrical	Steel
VSSD08L060S04-C	8	5.8	60	S04	Cylindrical	Carbide
VSSD10L055S05-S	10	7.6	55	S05	Cylindrical	Steel
VSSD12L065S06-S	12	9.6	65	S06	Cylindrical	Steel
VSSD16L065S08-S	16	11.6	65	S08	Cylindrical	Steel
VSSD20L070S10-S	20	15.3	70	S10	Cylindrical	Steel
VSSD25L075S12-S	25	18.3	75	S12	Cylindrical	Steel
VSSD32L100S15-S	32	23.9	100	S15	Cylindrical	Steel
VSSD40L100S21-S	40	30	100	S21	Cylindrical	Steel

VSSD...

Straight neck and cylindrical shank

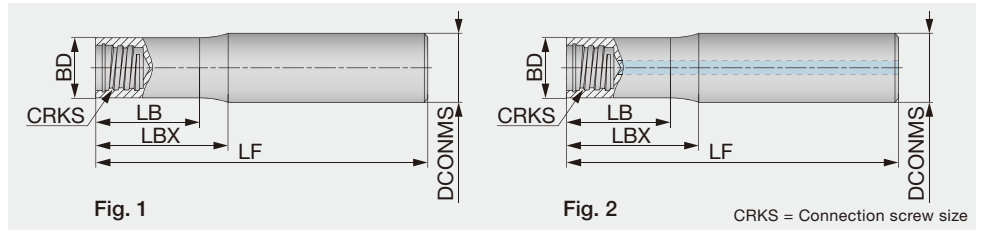

Designation	DCONMS	BD	LF	LBX	LB	CRKS	Shank shape	Shank material	Fig.
VSSD08L060S05-S	8	7.6	60	15	12.8	S05	Cylindrical	Steel	1
VSSD08L070S05-C	8	7.6	70	20	19	S05	Cylindrical	Carbide	1
VSSD08L090S05-C	8	7.6	90	40	39	S05	Cylindrical	Carbide	1
VSSD08L110S05-C	8	7.6	110	60	59	S05	Cylindrical	Carbide	1
VSSD10L070S06-C	10	9.6	70	20	18.5	S06	Cylindrical	Carbide	1
VSSD10L075S06-S	10	9.6	75	20	19.4	S06	Cylindrical	Steel	1
VSSD10L090S06-C	10	9.6	90	40	38.5	S06	Cylindrical	Carbide	1
VSSD10L110S06-C	10	9.6	110	60	58.5	S06	Cylindrical	Carbide	1
VSSD10L150S06-C	10	9.6	150	100	98.5	S06	Cylindrical	Carbide	1
VSSD12L070S08-C	12	11.5	70	20	17	S08	Cylindrical	Carbide	1
VSSD12L070S08-C-A	12	11.5	70	20	17	S08	Cylindrical	Carbide	2
VSSD12L090S08-C	12	11.5	90	40	37	S08	Cylindrical	Carbide	1
VSSD12L090S08-S	12	11.5	90	16	13.6	S08	Cylindrical	Steel	1
VSSD12L090S08-S-A	12	11.5	90	16	13.6	S08	Cylindrical	Steel	2
VSSD12L090LS08-C-A	12	11.5	90	40	37	S08	Cylindrical	Carbide	2
VSSD12L090LS08-S-A	12	11.5	90	42	37	S08	Cylindrical	Steel	2
VSSD12L110S08-C	12	11.5	110	60	58	S08	Cylindrical	Carbide	1
VSSD12L110S08-C-A	12	11.5	110	60	57	S08	Cylindrical	Carbide	2
VSSD12L130S08-C	12	11.5	130	80	78	S08	Cylindrical	Carbide	1
VSSD12L130S08-C-A	12	11.5	130	80	77	S08	Cylindrical	Carbide	2
VSSD16L090S10-C	16	15.2	90	40	38	S10	Cylindrical	Carbide	1
VSSD16L090S10-C-A	16	15.2	90	40	38	S10	Cylindrical	Carbide	2
VSSD16L100S10-S	16	15.2	100	20	18	S10	Cylindrical	Steel	1
VSSD16L100S10-S-A	16	15.2	100	20	18	S10	Cylindrical	Steel	2
VSSD16L100LS10-S-A	16	15.2	100	42	38	S10	Cylindrical	Steel	2
VSSD16L110S10-C	16	15.2	110	60	58	S10	Cylindrical	Carbide	1
VSSD16L110S10-C-A	16	15.2	110	60	58	S10	Cylindrical	Carbide	2
VSSD16L130S10-C	16	15.2	130	80	78	S10	Cylindrical	Carbide	1
VSSD16L130S10-C-A	16	15.2	130	80	78	S10	Cylindrical	Carbide	2
VSSD16L150S10-C	16	15.2	150	100	98	S10	Cylindrical	Carbide	1
VSSD20L090S12-C	20	18.3	90	40	37	S12	Cylindrical	Carbide	1
VSSD20L120S12-S	20	18.3	120	25	20.5	S12	Cylindrical	Steel	1
VSSD20L130S12-C	20	18.3	130	80	77	S12	Cylindrical	Carbide	1
VSSD20L200S12-C	20	18.3	200	120	117	S12	Cylindrical	Carbide	1
VSSD25L120S15-C	25	23.9	120	60	58	S15	Cylindrical	Carbide	1
VSSD25L135S15-S	25	23.9	135	35	33	S15	Cylindrical	Steel	1
VSSD25L170S15-C	25	23.9	170	100	98	S15	Cylindrical	Carbide	1
VSSD25L250S15-C	25	23.9	250	150	148	S15	Cylindrical	Carbide	1
VSSD32L100S21-S	32	30	100	35	32	S21	Cylindrical	Steel	1
VSSD32L150S21-S	32	30	150	54	50	S21	Cylindrical	Steel	1

CRKS = Connection screw size

Straight neck and weldon shank

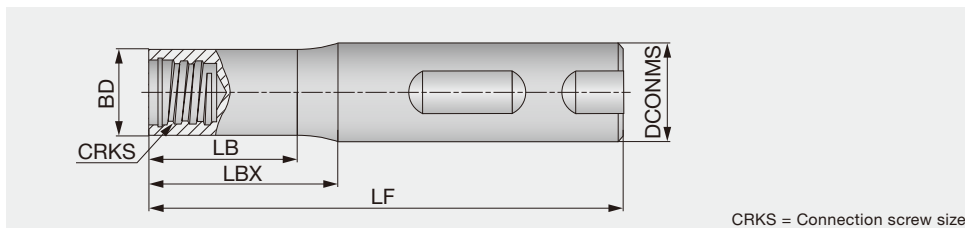

CRKS = Connection screw size

Designation	DCONMS	BD	LF	LBX	LB	CRKS	Shank shape	Shank material
VSSD12L055W05-S	12	7.6	55	3.8	-	S05	Weldon	Steel
VSSD16L065W06-S	16	9.6	65	6	-	S06	Weldon	Steel
VSSD16L065W08-S	16	11.5	65	4	-	S08	Weldon	Steel
VSSD20L070W10-S	20	15.2	70	4	-	S10	Weldon	Steel
VSSD25L075W12-S	25	18.3	75	6	-	S12	Weldon	Steel



Others

VTSD...

Taper neck and straight shank

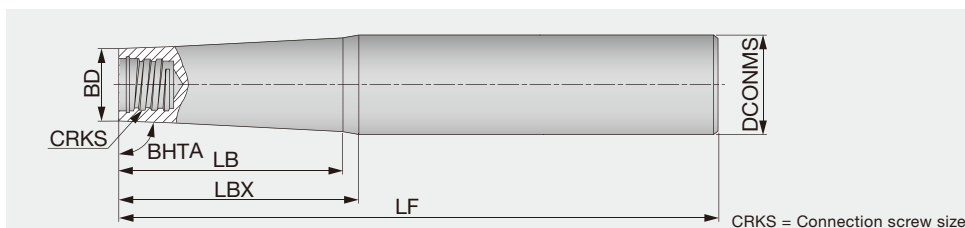

CRKS = Connection screw size

Designation	BHTA	DCONMS	BD	LF	LBX	LB	CRKS	Shank material
VTSD08L080S04-S	87.4°	8	5.8	80	24	-	S04	Steel
VTSD12L080S05-S	85°	12	7.6	80	25	-	S05	Steel
VTSD12L100S05-S	89°	12	7.6	100	35	29	S05	Steel
VTSD12L110S05-C	89°	12	7.6	110	60	56	S05	Carbide
VTSD12L130S05-C	89°	12	7.6	130	80	77	S05	Carbide
VTSD16L125S06-S	85°	16	9.6	125	34	31	S06	Steel
VTSD16L130S08-C	89°	16	11.5	130	80	76.5	S08	Carbide
VTSD16L140S08-S	85°	16	11.5	140	22	19	S08	Steel
VTSD16L150S05-C	89°	16	7.6	150	100	91	S05	Carbide
VTSD16L150S06-C	89°	16	9.6	150	100	94.5	S06	Carbide
VTSD16L150S08-C	89°	16	11.5	150	100	98	S08	Carbide
VTSD16L160S06-S	89°	16	9.6	160	55	46.5	S06	Steel
VTSD16L170S06-C	89°	16	9.6	170	120	116.5	S06	Carbide
VTSD20L140S10-S	85°	20	15.2	140	27.5	-	S10	Steel
VTSD20L170S08-C	89°	20	11.5	170	120	112	S08	Carbide
VTSD20L170S08-S	89°	20	11.5	170	80	69.5	S08	Steel
VTSD20L170S10-C	89°	20	15.2	170	120	119	S10	Carbide
VTSD20L190S10-C	89°	20	15.2	190	140	-	S10	Carbide
VTSD20L190S10-S	89°	20	15.2	190	80	73	S10	Steel
VTSD20L210S10-C	89°	20	15.2	210	160	-	S10	Carbide
VTSD25L160S12-S	85°	25	18.3	160	40	-	S12	Steel
VTSD25L170S10-S	85°	25	15.2	170	56	-	S10	Steel
VTSD25L180S12-C	89°	25	18.3	180	120	115	S12	Carbide
VTSD25L210S12-S	89°	25	18.3	210	100	94.5	S12	Steel
VTSD25L250S12-C	89°	25	18.3	250	140	136.5	S12	Carbide
VTSD32L155S15-S	85°	32	23.9	155	45	-	S15	Steel
VTSD32L190S12-S	85°	32	18.3	190	80	-	S12	Steel
VTSD32L220S15-S	88°	32	23.9	220	100	-	S15	Steel
VTSD32L250S15-C	89°	32	23.9	250	150	145	S15	Carbide
VTSD32L300S15-C	89°	32	23.9	300	200	198	S15	Carbide
VTSD40L150S21-S	85°	40	30	150	57	-	S21	Steel

VTSD**-W-A...

Straight shank and taper neck with coolant hole

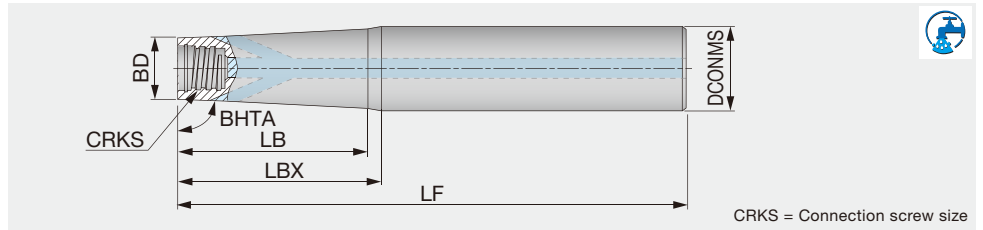

Designation	BHTA	DCONMS	BD	LF	LBX	LB	CRKS	Shank material
VTSD12L110S06-W-A	89°	12	9.6	110	60	59	S06	Tungsten
VTSD16L170S06-W-A	89°	16	9.6	170	120	116	S06	Tungsten

VSC...

Straight shank for VST type slotting heads

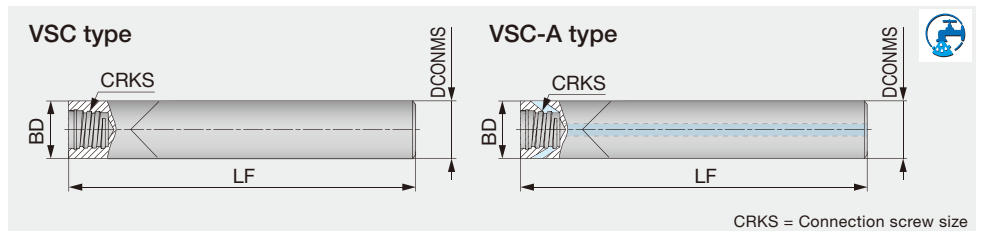

Designation	DCONMS	BD	LF	CRKS	Air hole	Shank material
VSC100L100S06-C	10	10	100	S06	without	Carbide
VSC120L100S08-C-A	12	12	100	S08	with	Carbide

For VSC-C type shank, just VST slotting head is recommended.

If other heads are used on the VSC-C shank, the depth of cut must be smaller than the max. ap in each head. The VSC-C type shank does not have external clearance, so the shank may interfere with the work piece.

VSTD...

Straight shank for VTB type T-slotting heads

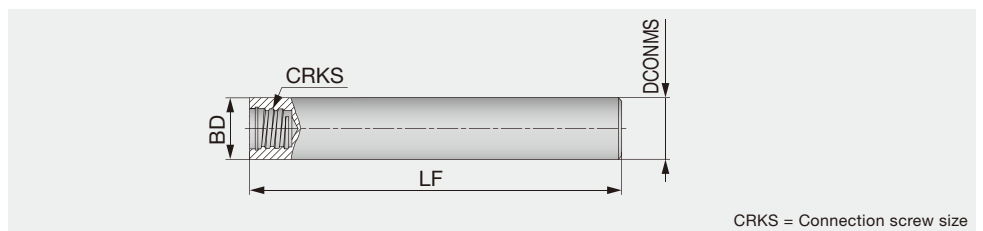

Designation	DCONMS	BD	LF	CRKS	Shank material
VSTD06L070S04-S	6	6	70	S04	Steel
VSTD08L070S05-S	8	8	70	S05	Steel
VSTD10L080S06-S	10	10	80	S06	Steel
VSTD12L090S08-S	12	12	90	S08	Steel
VSTD16L100S10-S	16	16	100	S10	Steel

For VSTD type shank, just VTB T-slotting head is recommended.

If other heads are used on the VSTD shank, the depth of cut must be smaller than the max. ap in each head. The VSTD type shank does not have external clearance, so the shank may interfere with the work piece.

TungFlex conversion adaptor

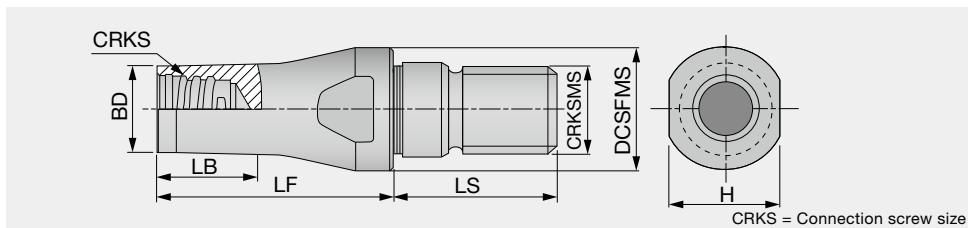

CRKS = Connection screw size

Designation	BD	DCSFMS	LF	LS	LB	CRKS	CRKSMS	H	Shank material
VAD130L016S08-S-M8	11.7	13	16	17.5	6	S08	M8	11	Steel
VAD130L025S08-S-M8	11.7	13	25	17.5	20	S08	M8	11	Steel
VAD180L020S08-S-M10	11.7	18	20	20	12	S08	M10	13	Steel
VAD180L025S08-S-M10	11.7	18	25	20	15	S08	M10	11	Steel
VAD210L020S08-S-M12	11.7	21	20	20	10	S08	M12	12.75	Steel
VAD210L025S08-S-M12	11.7	21	25	20	13	S08	M12	12.75	Steel

VER...

Straight neck with ER11/16 collet

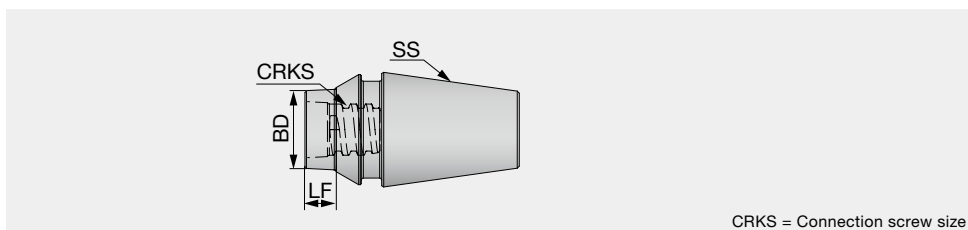

CRKS = Connection screw size

Designation	SS	BD	LF	CRKS	Shank material
VER11AL006S04-S	ER11	5.8	6	S04	Steel
VER11AL006S05-S	ER11	7.9	6	S05	Steel
VER11AL020S05-S	ER11	7.9	20	S05	Steel
VER16AL012S05-S	ER16	7.9	12	S05	Steel
VER16AL020S05-S	ER16	7.9	20	S05	Steel
VER16AL010S06-S	ER16	9.9	10	S06	Steel
VER16AL020S06-S	ER16	9.9	20	S06	Steel
VER16AL006S08-S	ER16	11.6	6	S08	Steel
VER16AL020S08-S	ER16	11.6	20	S08	Steel

■ WRENCH

Appearance	Designation	Connection screw size	Torque (N-m)	Applicable head
	KEYV-S05	S04	4	Square Ball Radius Drilling Chamfering Counterboring Barrel Lens Bull nose Indexable modular head
		S05	7	
	KEYV-S06	S06	10	
	KEYV-S08	S08	15	
	KEYV-S10	S10	28	
	KEYV-S12	S12	28	
	KEYV-W20	S15	40	Square Ball
	KS-24	S21	110	
	KEYV-177	S06	10	Slotting VST Threading VTR
	KEYV-217	S08	15	

Note: Wrenches are sold separately.

Appearance	Designation	Connection screw size	Torque (N-m)	Applicable head
	KEYV-T20	S05	7	Slotting VTB Face mill
		S06	10	
	KEYV-T25	S06	10	
	KEYV-T30L	S08	15	Slotting VST, VTB Face mill
	KEYV-T40L	S08	15	
		S10	28	
	KEYV-T50L	S08	15	Slotting VTB Face mill
		S10	28	

Note: Wrenches are sold separately.

TORQUE WRENCHES

Appearance	Designation	Stock	Connection screw size	TM Head description	Torque (N-m)
Handle 	TORQUEWRENCH5-50NM9x12	●	-	-	5 - 50
Open wrenches for cylindrical heads 	TM-WRENCH-6-05	●	S05	VEH, VED, VEE, VEE-I, VEE-R, VEE-C, VEE-A, VFX**-04/06, VRD, VBD-BG, VBE-BG, VBE-BGA, VDP, VDS, VCA, VBO, VBL, VBN, HPAV06-S	7
	TM-WRENCH-8-06	●	S06		10
	TM-WRENCH-10-08	●	S08		15
	TM-WRENCH-13-10	●	S10		28
	TM-WRENCH-16-12	●	S12		28
	TM-WRENCH-20-15	●	S15		40
Open wrenches for 2 flute heads 	TM-WRENCH-4E-05	●	S05	VRB, VRC, VFX**-02, VBB-BM, VBB-BG, VBB-SG, VCP, VGC, VCW, VCR	7
	TM-WRENCH-5E-06	●	S06		10
	TM-WRENCH-7E-08	●	S08		15
	TM-WRENCH-8E-10	●	S10		28
	TM-WRENCH-9E-12	●	S12		28
90° adaptor for Torx bits 	INSERT-TOOL-9X12MM	●	-	-	-
Torx bits sockets 	BIT-SOCKET-T20-DRIVE	●	S05, S06	VFM120, VTB135, VTB160W2.00, VTB165W2.00	7, 10
	BIT-SOCKET-T25-DRIVE	●	S06	VFM160, VTB160W3.00, VTB160W4.00, VTB165W3.00, VTB165W4.00	10
	BIT-SOCKET-T30-DRIVE	●	S08	VTB195	15
	BIT-SOCKET-T40-DRIVE	●	S08, S10	VFM200, VST277, VTB225	15, 28
	BIT-SOCKET-T50-DRIVE	●	S08, S10	VFM250, VTB250	15, 28

CAUTIONARY POINTS IN USE

- The cutting heads specified by Tungaloy must be used. Avoid using alternate heads that are not Tungaloy products as this will damage the shank and can cause severe accident or injury.
- Before setting the head, clean the connection screw with an air blast or a wiping cloth to remove chips and other foreign matter that may remain.
- Do not apply the lubricant to the connection screw.
- Please use the correct wrench with the correct cutting head. Tighten the head slowly until the face of the head contacts the shank. (Please refer to the picture shown on the right.) Do not re-tightening or over-tightening. Excessive tightening may cause the cutting head to break.
- Do not apply excessive force or a hammer when tightening or exchanging the cutting heads.

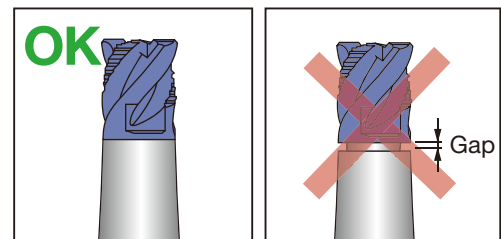

THREADMILLING

Highly economical tool design

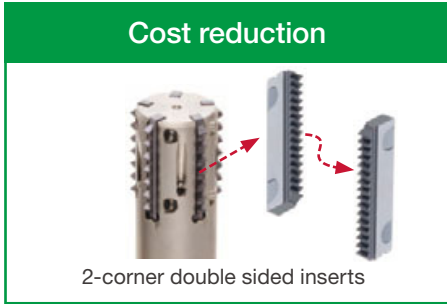

Tool selection guide for internal ISO metric threads

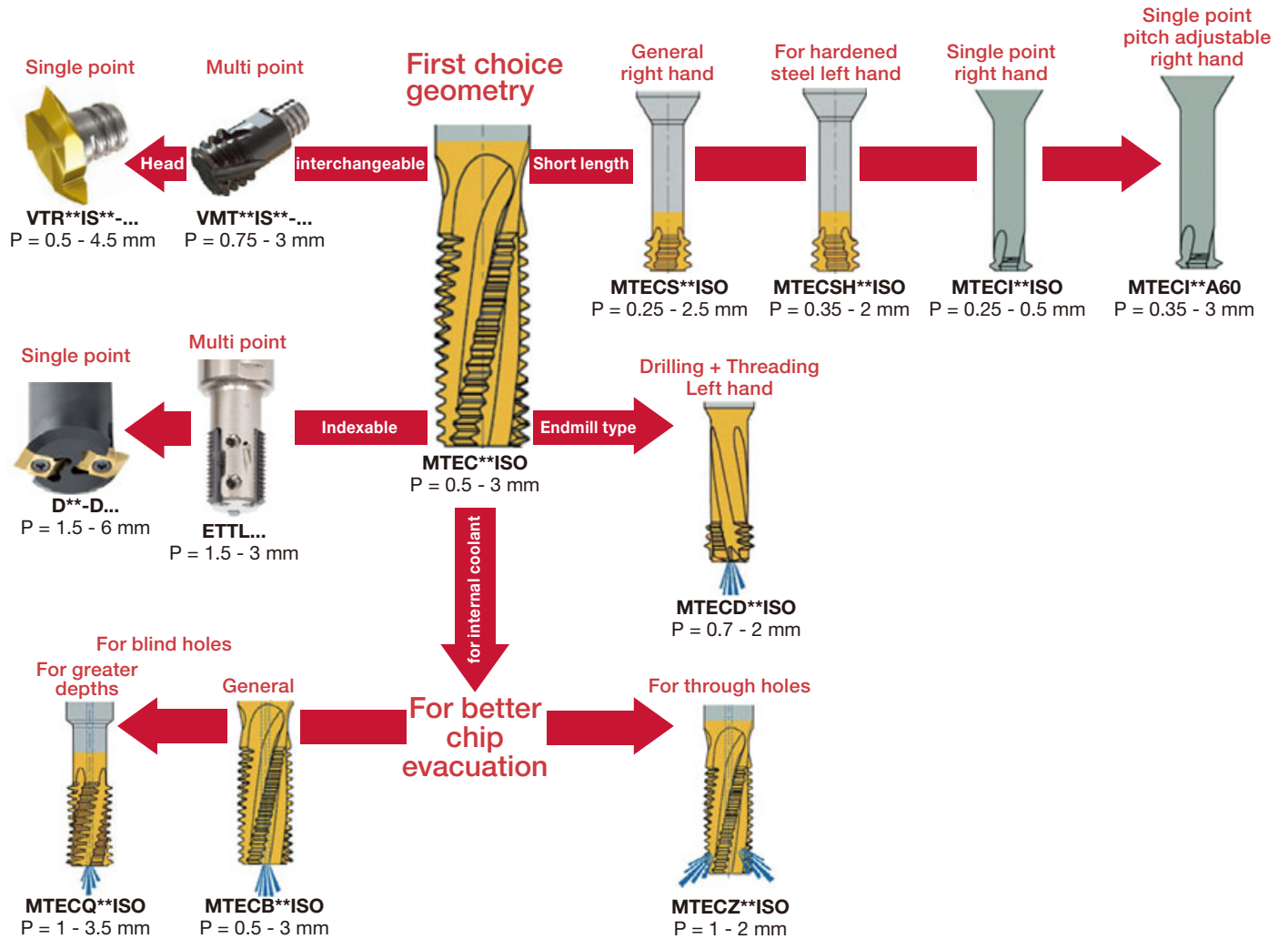

Reference pages: I107 - I129

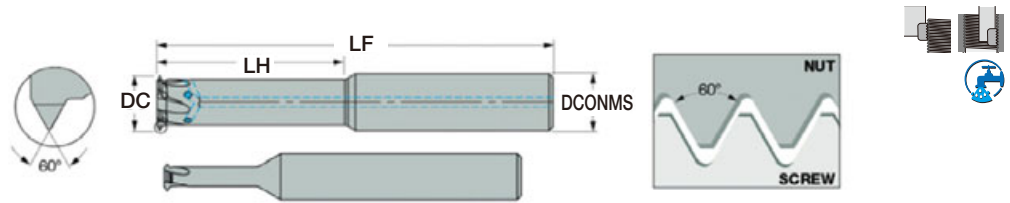

Designation	ISO Metric						Unified						DCONMS	DC	NOF	LH	LF	Coolant hole	Grade
	Internal			External			Internal			External									
	Pitch		Application range	Pitch		TPI	Pitch		TPI	Pitch		TPI							
	min.	max.		min.	max.		min.	max.		min.	max.								
MTECI03019C5A60	0.35	0.6	≥M2.5x0.35 ≥M2.5x0.4 ≥M2.5x0.45 ≥M3x0.5 ≥M3x0.6	0.35	0.6	40	72	≥#3-72UN ≥#3-64UN ≥#3-56UN ≥#3-48UN ≥#4-44UN ≥#4-40UN	40	72	3	1.9	3	5.2	39	Without	AH710		
MTECI06032C9A60	0.5	1.0	≥M4x0.5 ≥M4x0.6 ≥M4x0.7 ≥M4.5x0.75 ≥M4.5x0.8 ≥M5x1	0.5	1.0	24	48	≥#8-48UN ≥#8-44UN ≥#8-40UN ≥#8-36UN ≥#8-48UN ≥#10-28UN ≥#10-24UN	24	48	6	3.2	3	9.5	57	Without	AH710		
MTECI0604C12A60	0.5	1.0	≥M5x0.5 ≥M5x0.6 ≥M5x0.7 ≥M5x0.75 ≥M5x0.8 ≥M6x1	0.5	1.0	24	48	≥#10-48UN ≥#10-44UN ≥#10-40UN ≥#10-36UN ≥#12-32UN ≥#12-28UN ≥#12-24UN	24	48	6	4	3	12.5	58	Without	AH710		
MTECI0605D20A60	0.5	0.8	≥M6	0.4	0.8	28	56	≥M1/4	32	64	6	5	4	20	58	With	AH725		
MTECI0808D28A60	0.5	0.8	≥M9	0.4	0.8	28	56	≥M3/8	32	64	8	8	4	28	64	With	AH725		
MTECI0808D30A60	1.0	1.75	≥M10	0.8	1.5	14	28	≥M7/16	16	32	8	8	4	30	64	With	AH725		
MTECI1010D35A60	1.0	1.75	≥M12	0.8	1.5	14	28	≥M1/2	16	32	10	10	4	35	73	With	AH725		
MTECI1212E40A60	2.0	3.0	≥M16	1.75	2.5	8	13	≥M11/16	10	15	12	12	5	40	84	With	AH725		
MTECI1616E50A60	2.0	3.0	≥M20	1.75	2.5	8	13	≥M13/16	10	15	16	16	5	50	101	With	AH725		



SOLIDTHREAD**ISO metric (M)****MTECI-ISO**

Solid carbide internal threading endmill, for ISO metric profile

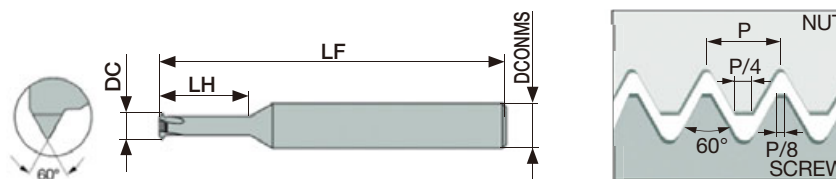

Designation	Pitch	Application range	DCONMS	DC	NOF	LH	LF	Coolant hole	Grade
MTECI03007C30.25ISO	0.25	≥M1	6	0.72	3	3.6	39	Without	AH710
MTECI03009C40.25ISO	0.25	≥M1.2	6	0.9	3	4.3	39	Without	AH710
MTECI03011C50.3ISO	0.3	≥M1.4	6	1.05	3	5.0	39	Without	AH710
MTECI03012C60.35ISO	0.35	≥M1.6	6	1.2	3	5.7	39	Without	AH710
MTECI03016C70.4ISO	0.4	≥M2	6	1.55	3	7.1	39	Without	AH710
MTECI03024C100.5ISO	0.5	≥M3	6	2.37	3	10.6	39	Without	AH710

MTEC-ISO

Solid carbide internal threading endmill, for ISO metric profile

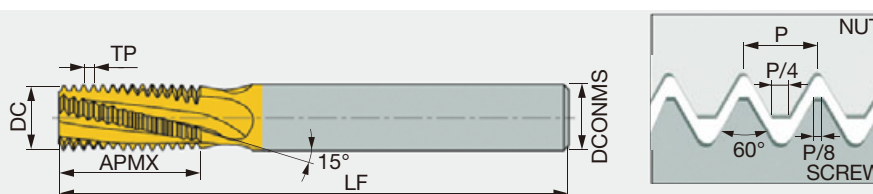

Designation	TP	Application range	DCONMS	DC	NOF	APMX	LF	Coolant hole	Grade
MTEC06022C50.5ISO	0.5	≥ M3	6	2.2	3	5.3	58	Without	AH725
MTEC06038C100.5ISO	0.5	≥ M5	6	3.8	3	10.3	58	Without	AH725
MTEC06031C70.7ISO	0.7	≥ M4	6	3.1	3	7.4	58	Without	AH725
MTEC06045C100.75ISO	0.75	≥ M6	6	4.5	3	10	58	Without	AH725
MTEC06036C90.8ISO	0.8	≥ M5	6	3.6	3	9.2	58	Without	AH725
MTEC0604C101.0ISO	1	≥ M6	6	4	3	10.5	58	Without	AH725
MTEC0604C141.0ISO	1	≥ M6	6	4	3	14.5	58	Without	AH725
MTEC0606C121.0ISO	1	≥ M9	6	6	3	12.5	58	Without	AH725
MTEC0808D161.0ISO	1	≥ M10	8	8	4	16.5	64	Without	AH725
MTEC0605C141.25ISO	1.25	≥ M8	6	5	3	14.4	58	Without	AH725
MTEC0605C191.25ISO	1.25	≥ M8	6	5	3	19.4	58	Without	AH725
MTEC0807C171.5ISO	1.5	≥ M10	8	7	3	17.3	64	Without	AH725
MTEC0807C241.5ISO	1.5	≥ M10	8	7	3	24.8	76	Without	AH725
MTEC1010D211.5ISO	1.5	≥ M14	10	10	4	21.8	73	Without	AH725
MTEC1616F331.5ISO	1.5	≥ M20	16	16	6	33.8	105	Without	AH725
MTEC0808C201.75ISO	1.75	≥ M12	8	8	3	20.1	64	Without	AH725
MTEC0808C281.75ISO	1.75	≥ M12	8	8	3	28.9	76	Without	AH725
MTEC1010C272.0ISO	2	≥ M14	10	10	3	27	73	Without	AH725
MTEC1010C392.0ISO	2	≥ M14	10	10	3	39	105	Without	AH725
MTEC1212D272.0ISO	2	≥ M18	12	12	4	27	84	Without	AH725
MTEC2020F412.0ISO	2	≥ M24	20	20	6	41	105	Without	AH725
MTEC1414D332.5ISO	2.5	≥ M20	14	14	4	33.8	84	Without	AH725
MTEC1414D482.5ISO	2.5	≥ M20	14	14	4	48.8	105	Without	AH725
MTEC1616C403.0ISO	3	≥ M24	16	16	3	40.5	105	Without	AH725
MTEC1616C583.0ISO	3	≥ M24	16	16	3	58.5	120	Without	AH725

Reference pages: Standard cutting conditions → [I120](#) - [I122](#)

MTECB-ISO

Solid carbide internal threading endmill, with coolant hole, for ISO metric profile

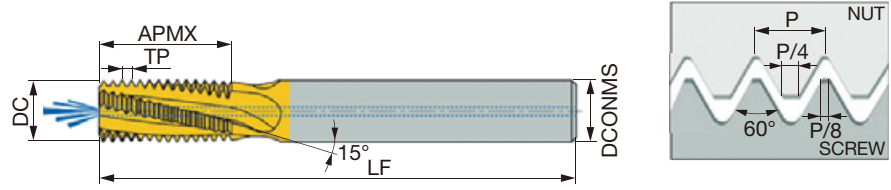

Designation	TP	Application range	DCONMS	DC	NOF	APMX	LF	Coolant hole	Grade
MTECB06038C100.5ISO	0.5	≥ M5	6	3.8	3	10.3	58	With	AH725
MTECB06031C70.7ISO	0.7	≥ M4	6	3.1	3	7.4	58	With	AH725
MTECB06045C100.75ISO	0.75	≥ M6	6	4.5	3	10.1	58	With	AH725
MTECB1010D240.75ISO	0.75	≥ M12	10	10	4	24.4	73	With	AH725
MTECB06038C90.8ISO	0.8	≥ M5	6	3.8	3	9.2	58	With	AH725
MTECB06046C101.0ISO	1	≥ M6	6	4.6	3	10.5	58	With	AH725
MTECB06046C141.0ISO	1	≥ M6	6	4.6	3	14.5	58	With	AH725
MTECB0606C121.0ISO	1	≥ M9	6	6	3	12.5	58	With	AH725
MTECB0808D161.0ISO	1	≥ M10	8	8	4	16.5	64	With	AH725
MTECB1010D241.0ISO	1	≥ M12	10	10	4	24.5	73	With	AH725
MTECB0606C141.25ISO	1.25	≥ M8	6	6	3	14.4	58	With	AH725
MTECB0606C191.25ISO	1.25	≥ M8	6	6	3	19.4	58	With	AH725
MTECB08078C171.5ISO	1.5	≥ M10	8	7.8	3	17	64	With	AH725
MTECB08078C241.5ISO	1.5	≥ M10	8	7.8	3	24.8	76	With	AH725
MTECB1010D211.5ISO	1.5	≥ M14	10	10	4	21.8	73	With	AH725
MTECB1212D261.5ISO	1.5	≥ M16	12	12	4	26.3	84	With	AH725
MTECB1616F331.5ISO	1.5	≥ M20	16	16	6	33.8	105	With	AH725
MTECB1009C201.75ISO	1.75	≥ M12	10	9	3	20.1	73	With	AH725
MTECB1009C281.75ISO	1.75	≥ M12	10	9	3	28.9	73	With	AH725
MTECB1010C272.0ISO	2	≥ M14	10	10	3	27	73	With	AH725
MTECB12118D272.0ISO	2	≥ M16	12	11.8	4	27	84	With	AH725
MTECB12118D392.0ISO	2	≥ M16	12	11.8	4	39	105	With	AH725
MTECB1615E332.5ISO	2.5	≥ M20	16	15	5	33.8	105	With	AH725
MTECB1615E482.5ISO	2.5	≥ M20	16	15	5	48.8	105	With	AH725
MTECB2018D583.0ISO	3	≥ M24	20	18	4	58.5	120	With	AH725

Reference pages: Standard cutting conditions → [I120 - I122](#)



SOLIDTHREAD

MTECQ-ISO

Solid carbide deep internal threading endmill, with internal coolant hole, for ISO metric profile

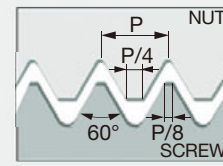
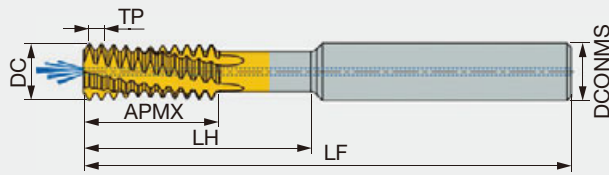

Designation	TP	Application range	DCONMS	DC	NOF	APMX	LH	LF	Coolant hole	Grade
MTECQ1212D381.0ISO	1	≥M14	12	12	4	21	38	84	With	AH725
MTECQ1010D301.5ISO	1.5	≥M13	10	10	4	18	30	73	With	AH725
MTECQ2020F562.0ISO	2	≥M24	20	20	6	34	56	105	With	AH725
MTECQ2020D453.5ISO	3.5	≥M26	20	20	4	28	45.5	105	With	AH725

MTECZ-ISO

Solid carbide internal threading endmill for through hole, with coolant hole in the flute, for ISO metric profile

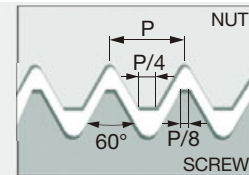
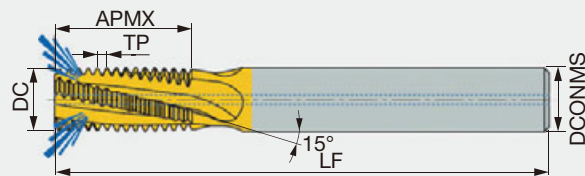

Designation	TP	Application range	DCONMS	DC	NOF	APMX	LF	Coolant hole	Grade
MTECZ06048C101.0ISO	1	≥ M6	6	4.8	3	10.5	58	With	AH725
MTECZ0808D161.0ISO	1	≥ M10	8	8	4	16.5	64	With	AH725
MTECZ0606C141.25ISO	1.25	≥ M8	6	6	3	14.4	58	With	AH725
MTECZ0606C191.25ISO	1.25	≥ M8	6	6	3	19.4	58	With	AH725
MTECZ08078C171.5ISO	1.5	≥ M10	8	7.8	3	17	64	With	AH725
MTECZ1010D211.5ISO	1.5	≥ M14	10	10	4	21.8	73	With	AH725
MTECZ1212D261.5ISO	1.5	≥ M16	12	12	4	26.3	84	With	AH725
MTECZ1616E331.5ISO	1.5	≥ M20	16	16	5	33.8	101	With	AH725
MTECZ1009C281.75ISO	1.75	≥ M12	10	9	3	28.9	73	With	AH725
MTECZ1010C272.0ISO	2	≥ M14	10	10	3	27	73	With	AH725
MTECZ12118D272.0ISO	2	≥ M16	12	11.8	4	27	84	With	AH725

Reference pages: Standard cutting conditions → [I120 - I122](#)

MTECS-ISO

Small diameter solid carbide internal threading endmill, short edge type, for ISO metric profile

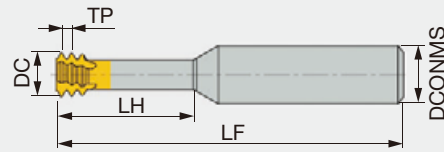

Designation	TP	Application range	DCONMS	DC	NOF	LH	LF	Coolant hole	Grade
MTECS03007C20.25ISO	0.25	≥M1	3	0.72	3	2.5	39	Without	AH725
MTECS03009C30.25ISO	0.25	≥M1.2	3	0.9	3	3	39	Without	AH725
MTECS03011C40.3ISO	0.3	≥M1.4	3	1.05	3	4	39	Without	AH725
MTECS03012C50.35ISO	0.35	≥M1.6	3	1.2	3	4.8	39	Without	AH725
MTECS03016C60.4ISO	0.4	≥M2	3	1.53	3	6	39	Without	AH725
MTECS06016C40.4ISO	0.4	≥M2	6	1.53	3	4.5	58	Without	AH725
MTECS03017C70.45ISO	0.45	≥M2.2	3	1.65	3	7	39	Without	AH725
MTECS06017C50.45ISO	0.45	≥M2.2	6	1.65	3	5	58	Without	AH725
MTECS0602C50.45ISO	0.45	≥M2.5	6	1.95	3	5.5	58	Without	AH725
MTECS0602C70.45ISO	0.45	≥M2.5	6	1.95	3	7.5	58	Without	AH725
MTECS06024C60.5ISO	0.5	≥M3	6	2.37	3	6.5	58	Without	AH725
MTECS06024C90.5ISO	0.5	≥M3	6	2.37	3	9.5	58	Without	AH725
MTECS06024C90.5ISOL	0.5	≥M3	6	2.37	3	9.5	105	Without	AH725
MTECS03024C120.5ISO	0.5	≥M3	3	2.4	3	12.5	39	Without	AH725
MTECS03024C150.5ISO	0.5	≥M3	3	2.4	3	15.5	39	Without	AH725
MTECS06054D200.5ISO	0.5	≥M6	6	5.35	4	20	58	Without	AH725
MTECS06028C100.6ISO	0.6	≥M3.5	6	2.75	3	10.5	58	Without	AH725
MTECS06028C70.6ISO	0.6	≥M3.5	6	2.75	3	7.5	58	Without	AH725
MTECS06031C120.7ISO	0.7	≥M4	6	3.1	3	12.5	58	Without	AH725
MTECS06031C120.7ISOL	0.7	≥M4	6	3.1	3	12.5	105	Without	AH725
MTECS06031C160.7ISO	0.7	≥M4	6	3.1	3	16.7	58	Without	AH725
MTECS06031C90.7ISO	0.7	≥M4	6	3.1	3	9	58	Without	AH725
MTECS0808D250.75ISO	0.75	≥M10	8	8	4	25	64	Without	AH725
MTECS06038C120.8ISO	0.8	≥M5	6	3.8	3	12.5	58	Without	AH725
MTECS06038C160.8ISO	0.8	≥M5	6	3.8	3	16	58	Without	AH725
MTECS06038C160.8ISOL	0.8	≥M5	6	3.8	3	16	105	Without	AH725
MTECS06047C141.0ISO	1	≥M6	6	4.65	3	14	58	Without	AH725
MTECS06047C201.0ISO	1	≥M6	6	4.65	3	20	58	Without	AH725
MTECS06047C201.0ISOL	1	≥M6	6	4.65	3	20	105	Without	AH725
MTECS0606C181.25ISO	1.25	≥M8	6	6	3	18	58	Without	AH725
MTECS0606C241.25ISO	1.25	≥M8	6	6	3	24	58	Without	AH725
MTECS08078C231.5ISO	1.5	≥M10	8	7.8	3	23	64	Without	AH725
MTECS08078C311.5ISO	1.5	≥M10	8	7.8	3	31.5	64	Without	AH725
MTECS1009C261.75ISO	1.75	≥M12	10	9	3	26	73	Without	AH725
MTECS12118D352.0ISO	2	≥M16	12	11.8	4	35	84	Without	AH725
MTECS12118D502.0ISO	2	≥M16	12	11.8	4	50	105	Without	AH725
MTECS1615E432.5ISO	2.5	≥M20	16	15	5	43	100	Without	AH725

Reference pages: Standard cutting conditions → [I120](#) - [I122](#)



Small diameter solid carbide internal threading endmill, short edge type, left hand cutting, for ISO metric profile

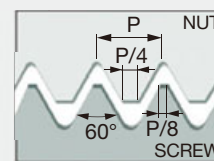
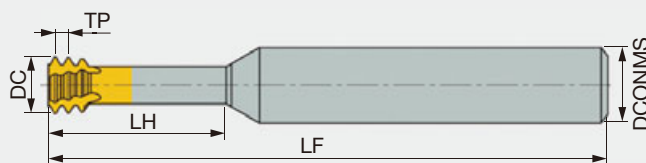

Designation	TP	Application range	DCONMS	DC	NOF	LH	LF	Coolant hole	Grade
MTECSH03012C50.35ISO	0.35	≥M1.6	3	1.2	3	4.8	39	Without	AH750
MTECSH03016C60.4ISO	0.4	≥M2	3	1.55	3	6	39	Without	AH750
MTECSH06016C40.4ISO	0.4	≥M2	6	1.55	3	4.5	58	Without	AH750
MTECSH06017C50.45ISO	0.45	≥M2.2	6	1.65	3	5	58	Without	AH750
MTECSH0602C50.45ISO	0.45	≥M2.5	6	1.95	3	5.5	58	Without	AH750
MTECSH0602C70.45ISO	0.45	≥M2.5	6	1.95	3	7.5	58	Without	AH750
MTECSH06024C60.5ISO	0.5	≥M3	6	2.35	3	6.5	58	Without	AH750
MTECSH06024C90.5ISO	0.5	≥M3	6	2.35	3	9.5	58	Without	AH750
MTECSH06028C70.6ISO	0.6	≥M3.5	6	2.75	3	7.5	58	Without	AH750
MTECSH06031C120.7ISO	0.7	≥M4	6	3.1	3	12.5	58	Without	AH750
MTECSH06038C120.8ISO	0.8	≥M5	6	3.8	3	12.5	58	Without	AH750
MTECSH06047C141.0ISO	1	≥M6	6	4.65	3	14	58	Without	AH750
MTECSH06047C201.0ISO	1	≥M6	6	4.65	3	20	58	Without	AH750
MTECSH0606C181.25ISO	1.25	≥M8	6	5.95	3	18	58	Without	AH750
MTECSH0606C241.25ISO	1.25	≥M8	6	5.95	3	24	58	Without	AH750
MTECSH08078C231.5ISO	1.5	≥M10	8	7.8	3	23	64	Without	AH750
MTECSH1009C261.75ISO	1.75	≥M12	10	9	3	26	73	Without	AH750
MTECSH12118D352.0ISO	2	≥M16	12	11.8	4	35	84	Without	AH750

MTECD-ISO

Small diameter solid carbide endmill for internal threading, drilling, and chamfering, short edge type, left hand cutting, for ISO metric profile

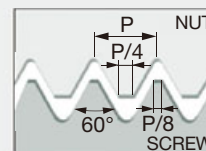
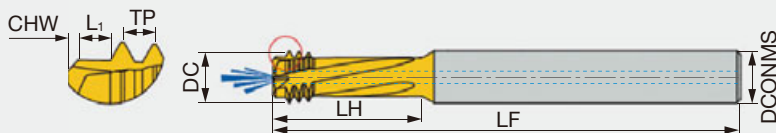

Designation	TP	Application range	DCONMS	DC	NOF	LH	LF	CHW	L1	Coolant hole	Grade
MTECD06032C110.7ISO	0.7	M4	6	3.15	3	11.6	58	0.2	0.7	Without	AH725
MTECD0604C140.8ISO	0.8	M5	6	4	3	14.4	58	0.3	0.8	Without	AH725
MTECD08047C141.0ISO	1	M6-M7	8	4.7	3	14	64	0.4	1	With	AH725
MTECD08061D181.25ISO	1.25	M8-M9	8	6.1	4	18	64	0.5	1.3	With	AH725
MTECD08078D231.5ISO	1.5	M10-M12	8	7.8	4	23	64	0.6	1.5	With	AH725
MTECD1009D261.75ISO	1.75	M12-M14	10	9	4	26	73	0.6	1.8	With	AH725
MTECD12118D352.0ISO	2	M16-M19	12	11.8	4	35	84	0.6	2	With	AH725

MTECE-ISO

Solid carbide external threading endmill, for ISO metric profile

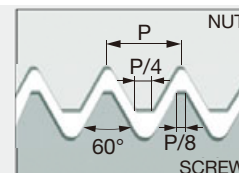
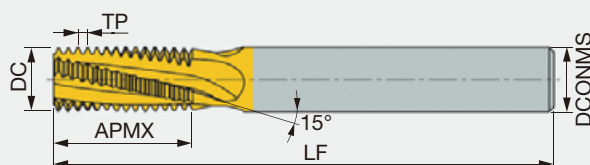

Designation	TP	DCONMS	DC	NOF	APMX	LF	Coolant hole	Grade
MTECE1010D161.0ISO	1	10	10	4	16.5	73	Without	AH725
MTECE1010D161.25ISO	1.25	10	10	4	16.9	73	Without	AH725
MTECE1010D151.5ISO	1.5	10	10	4	15.8	73	Without	AH725
MTECE1212D201.5ISO	1.5	12	12	4	20.3	84	Without	AH725
MTECE1212D201.75ISO	1.75	12	12	4	20.1	84	Without	AH725
MTECE1212D212.0ISO	2	12	12	4	21	84	Without	AH725

Unified (UN, UNC, UNF, UNFE, UNS)

MTEC-UN

Solid carbide internal threading endmill, for UN profile

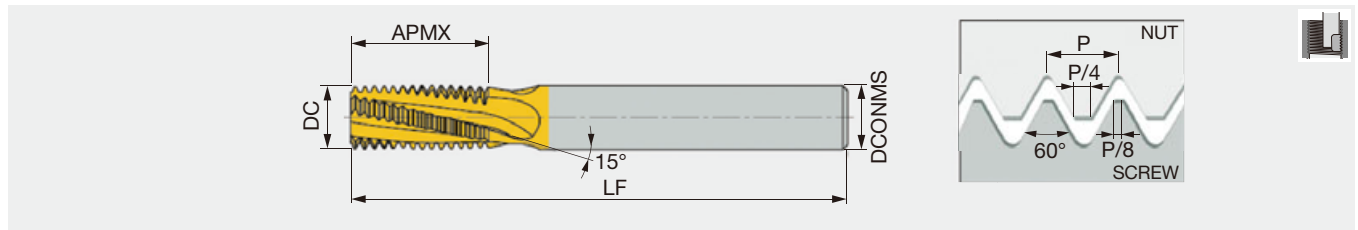

Designation	TPI	Application range	DCONMS	DC	NOF	APMX	LF	Coolant hole	Grade
MTEC06032C632UN	32	≤ #8 (0.164)	6	3.2	3	6.8	58	Without	AH725
MTEC0604C1128UN	28	≤ 1/4	6	4	3	11.3	58	Without	AH725
MTEC0606C1428UN	28	≤ 5/16	6	6	3	14.5	58	Without	AH725
MTEC0605C1424UN	24	≤ 5/16	6	5	3	14.3	58	Without	AH725
MTEC0807C2124UN	24	≤ 3/8	8	7	3	20	64	Without	AH725
MTEC06045C1220UN	20	≤ 1/4	6	4.5	3	12.1	58	Without	AH725
MTEC0807C2120UN	20	≤ 7/16	8	7	3	20	64	Without	AH725
MTEC1212E2720UN	20	≤ 11/16	12	12	5	27.3	84	Without	AH725
MTEC0605C1418UN	18	≤ 5/16	6	5	3	14.8	58	Without	AH725
MTEC1010D2618UN	18	≤ 9/16	10	10	4	26.1	73	Without	AH725
MTEC0606C1616UN	16	≤ 3/8	6	6	3	16.7	58	Without	AH725
MTEC1212D3116UN	16	≤ 5/8	12	12	4	30	84	Without	AH725
MTEC1615E3714UN	14	≤ 13/16	16	15	5	37.2	105	Without	AH725
MTEC0808C2213UN	13	≤ 1/2	8	8	3	22.5	64	Without	AH725
MTEC1010C2612UN	12	≤ 9/16	10	10	3	26.5	73	Without	AH725
MTEC1616E4112UN	12	≤ 13/16	16	16	5	41.3	105	Without	AH725
MTEC1010C2811UN	11	≤ 5/8	10	10	3	28.9	73	Without	AH725
MTEC1212C3410UN	10	≤ 11/16	12	12	3	34.3	84	Without	AH725
MTEC1615C389UN	9	≤ 7/8	16	15	3	38.1	105	Without	AH725
MTEC1616C428UN	8	≤ 15/16	16	16	3	42.9	105	Without	AH725

MTECB-UN

Solid carbide internal threading endmill, with coolant hole, for UN profile

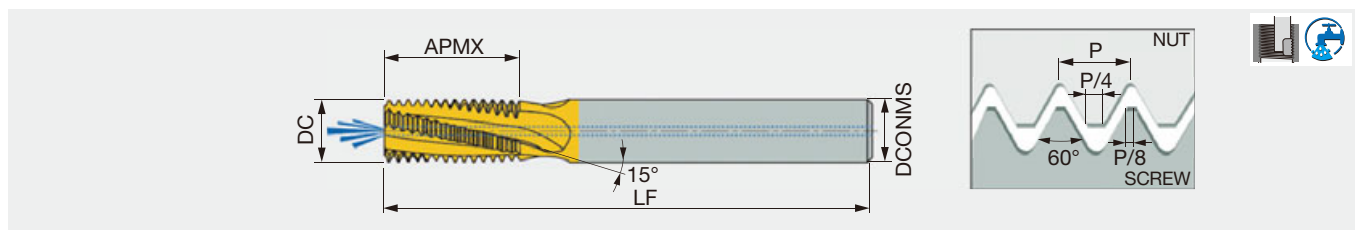

Designation	TPI	Application range	DCONMS	DC	NOF	APMX	LF	Coolant hole	Grade
MTECB06032C632UN	32	≥ #8 (0.164)	6	3.2	3	6.8	58	With	AH725
MTECB0606C1432UN	32	≥ 5/16	6	6	3	16	58	With	AH725
MTECB0605C1128UN	28	≥ 1/4	6	5	3	11.3	58	With	AH725
MTECB08066C1424UN	24	≥ 5/16	8	6.6	3	14.3	64	With	AH725
MTECB0808D2124UN	24	≥ 3/8	8	8	4	20.6	64	With	AH725
MTECB0808C2120UN	20	≥ 7/16	8	8	3	21	64	With	AH725
MTECB1010D2220UN	20	≥ 1/2	10	10	4	22.3	73	With	AH725
MTECB06056C1418UN	18	≥ 5/16	6	5.6	3	14.8	58	With	AH725
MTECB12113D2618UN	18	≥ 9/16	12	11.3	4	26.1	84	With	AH725
MTECB08067C1616UN	16	≥ 3/8	8	6.7	3	16.7	64	With	AH725
MTECB1212D3116UN	16	≥ 5/8	12	12	4	31	84	With	AH725
MTECB1616E3714UN	14	≥ 13/16	16	16	5	37.2	105	With	AH725
MTECB10092C2213UN	13	≥ 1/2	10	9.2	3	22.5	73	With	AH725
MTECB12114C2811UN	11	≥ 5/8	12	11.4	3	28.9	84	With	AH725
MTECB16144D3410UN	10	≥ 3/4	16	14.4	4	34.3	105	With	AH725
MTECB20195D428UN	8	≥ 1	20	19.5	4	42.9	105	With	AH725

Reference pages: Standard cutting conditions → [I120 - I122](#)

Solid carbide internal threading endmill, with coolant hole in the flute, for UN profile

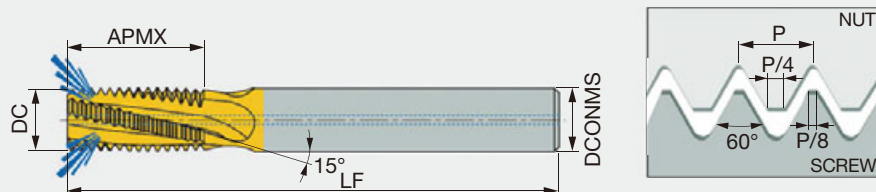

Designation	TPI	Application range	DCONMS	DC	NOF	APMX	LF	Coolant hole	Grade
MTECZ1010D2220UN	20	≥ 1/2	10	10	4	22.3	73	With	AH725
MTECZ12113D2618UN	18	≥ 9/16	12	11.3	4	26.1	84	With	AH725
MTECZ08067C1616UN	16	≥ 3/8	8	6.7	3	16.7	64	With	AH725
MTECZ16144D3410UN	10	≥ 3/4	16	14.4	4	34.3	101	With	AH725

MTECS-UN

Small diameter solid carbide internal threading endmill, short edge type, for UN profile

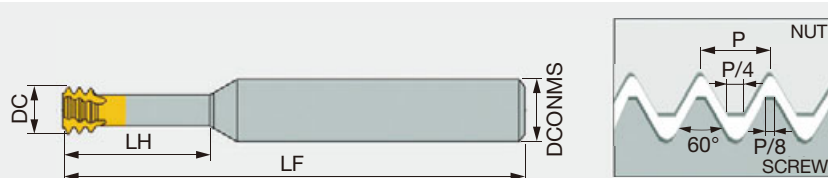

Designation	TPI	Application range	DCONMS	DC	NOF	LH	LF	Coolant hole	Grade
MTECS03012C880UN	80	≤ #0 (0.060)	3	1.15	3	8	39	Without	AH725
MTECS03015C672UN	72	≤ #1 (0.073)	3	1.45	3	6	39	Without	AH725
MTECS06016C656UN	56	≤ #2 (0.086)	6	1.65	3	6.6	58	Without	AH725
MTECS06016C456UN	56	≤ #2 (0.086)	6	1.65	3	4.4	58	Without	AH725
MTECS06019C548UN	48	≤ #3 (0.099)	6	1.9	3	5.2	58	Without	AH725
MTECS03021C1240UN	40	≤ #4 (0.112)	3	2.1	3	12	39	Without	AH725
MTECS06021C840UN	40	≤ #4 (0.112)	6	2.1	3	8	58	Without	AH725
MTECS06021C640UN	40	≤ #4 (0.112)	6	2.1	3	6.3	58	Without	AH725
MTECS06024C940UN	40	≤ #5 (0.125)	6	2.45	3	9.6	58	Without	AH725
MTECS06033C936UN	36	≤ #8 (0.164)	6	3.3	3	9	58	Without	AH725
MTECS06025C732UN	32	≤ #6 (0.138)	6	2.55	3	7.1	58	Without	AH725
MTECS06025C1032UN	32	≤ #6 (0.138)	6	2.55	3	10.5	58	Without	AH725
MTECS06032C932UN	32	≤ #8 (0.164)	6	3.2	3	9.5	58	Without	AH725
MTECS06032C1232UN	32	≤ #8 (0.164)	6	3.2	3	12.5	58	Without	AH725
MTECS06037C1032UN	32	≤ #10 (0.190)	6	3.7	3	10.5	58	Without	AH725
MTECS06037C1532UN	32	≤ #10 (0.190)	6	3.7	3	15	58	Without	AH725
MTECS0605C1428UN	28	≤ 1/4	6	5	3	14.5	58	Without	AH725
MTECS0605C1928UN	28	≤ 1/4	6	5	3	19	58	Without	AH725
MTECS08066C1724UN	24	≤ 5/16	8	6.6	3	17	64	Without	AH725
MTECS08066C2424UN	24	≤ 5/16	8	6.6	3	24	64	Without	AH725
MTECS06047C1420UN	20	≤ 1/4	6	4.75	3	14	58	Without	AH725
MTECS06047C1920UN	20	≤ 1/4	6	4.75	3	19	58	Without	AH725
MTECS06047C1920UN-L	20	≤ 1/4	6	4.75	3	19	105	Without	AH725
MTECS0808C2520UN	20	≤ 7/16	8	8	3	25	64	Without	AH725
MTECS0606C1718UN	18	≤ 5/16	6	6	3	17	58	Without	AH725
MTECS0606C2318UN	18	≤ 5/16	6	6	3	23	58	Without	AH725
MTECS1212D3518UN	18	≤ 5/8	12	12	4	35	84	Without	AH725
MTECS08067C2216UN	16	≤ 3/8	8	6.7	3	22	64	Without	AH725
MTECS08067C3016UN	16	≤ 3/8	8	6.7	3	30.2	64	Without	AH725
MTECS08077C2514UN	14	≤ 7/16	8	7.7	3	25	64	Without	AH725
MTECS10092C2713UN	13	≤ 1/2	10	9.2	3	27.5	73	Without	AH725
MTECS12114C3411UN	11	≤ 5/8	12	11.4	3	34.5	84	Without	AH725
MTECS12114C5011UN	11	≤ 5/8	12	11.4	3	50	105	Without	AH725

Reference pages: Standard cutting conditions → I120 - I122

MTECSH-UN

Small diameter solid carbide internal threading endmill, short edge type, left hand cutting, for UN profile, for hardened steel

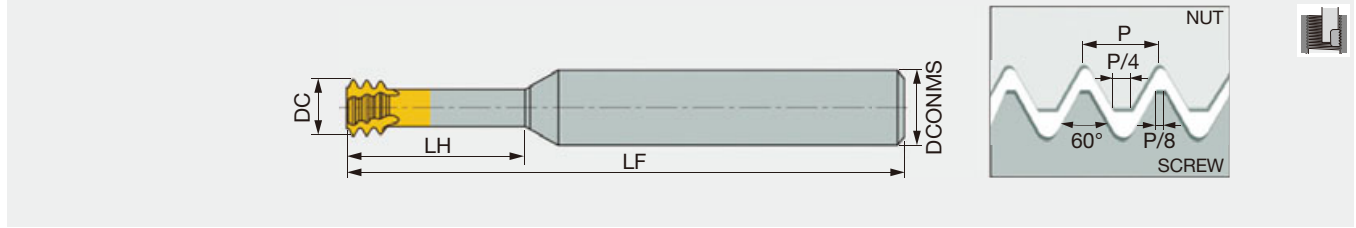

Designation	TPI	Application range	DCONMS	DC	NOF	LH	LF	Coolant hole	Grade
MTECSH06012C480UN	80	≥ #0 (0.060)	6	1.15	3	4	58	Without	AH725
MTECSH06016C656UN	56	≥ #2 (0.086)	6	1.65	3	6.6	58	Without	AH725
MTECSH06019C548UN	48	≥ #3 (0.099)	6	1.9	3	5.2	58	Without	AH725
MTECSH06021C640UN	40	≥ #4 (0.112)	6	2.1	3	6.3	58	Without	AH725
MTECSH06021C840UN	40	≥ #4 (0.112)	6	2.1	3	8	58	Without	AH725
MTECSH06024C740UN	40	≥ #5 (0.125)	6	2.45	3	7	58	Without	AH725
MTECSH06024C940UN	40	≥ #5 (0.125)	6	2.45	3	9.6	58	Without	AH725
MTECSH06025C1032UN	32	≥ #6 (0.138)	6	2.55	3	10.5	58	Without	AH725
MTECSH06032C932UN	32	≥ #8 (0.164)	6	3.2	3	9.5	58	Without	AH725
MTECSH06037C1032UN	32	≥ #10 (0.190)	6	3.7	3	10.5	58	Without	AH725
MTECSH06037C1532UN	32	≥ #10 (0.190)	6	3.7	3	15	58	Without	AH725
MTECSH06042C1128UN	28	≥ #12 (0.216)	6	4.2	3	11	58	Without	AH725
MTECSH0605C1428UN	28	≥ 1/4	6	5	3	14.5	58	Without	AH725
MTECSH06035C1024UN	24	≥ #10 (0.190)	6	3.5	3	10.6	58	Without	AH725
MTECSH08066C1724UN	24	≥ 5/16	8	6.6	3	17	64	Without	AH725
MTECSH08066C2424UN	24	≥ 5/16	8	6.6	3	24	64	Without	AH725
MTECSH06047C1920UN	20	≥ 1/4	6	4.75	3	19	58	Without	AH725
MTECSH0808C2520UN	20	≥ 7/16	8	8	3	25	64	Without	AH725
MTECSH0606C1718UN	18	≥ 5/16	6	6	3	17	58	Without	AH725
MTECSH0606C2318UN	18	≥ 5/16	6	6	3	23	58	Without	AH725
MTECSH08067C2216UN	16	≥ 3/8	8	6.7	3	22	64	Without	AH725
MTECSH08077C2514UN	14	≥ 7/16	8	7.7	3	25	64	Without	AH725
MTECSH10092C2713UN	13	≥ 1/2	10	9.2	3	27.5	73	Without	AH725
MTECSH12114C3411UN	11	≥ 5/8	12	11.4	3	34.5	84	Without	AH725

MTEC E-UN

Solid carbide external threading endmill, for UN profile

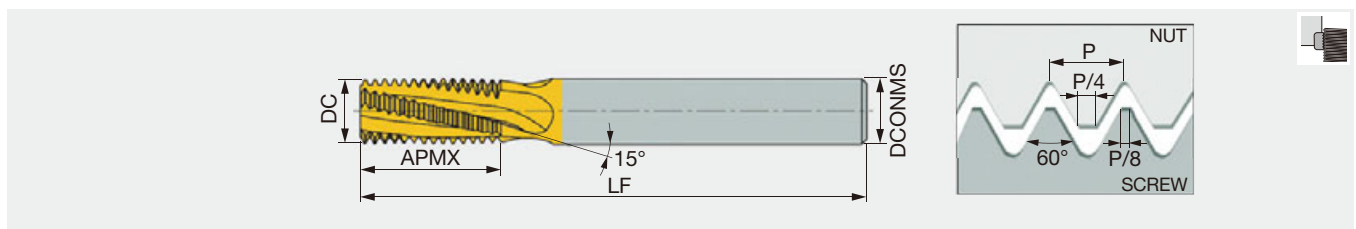

Designation	TPI	DCONMS	DC	NOF	APMX	LF	Coolant hole	Grade
MTECE1010D1624UN	24	10	10	4	16.4	73	Without	AH725
MTECE1212E2120UN	20	12	12	5	21	84	Without	AH725

SOLIDTHREAD**Whitworth parallel pipe thread (G, Rp, BSP, PF, PS)****MTEC-W**

Solid carbide internal and external threading endmill, for G, BSP profile



Designation	TPI	Application range	DCONMS	DC	NOF	APMX	LF	Coolant hole	Grade
MTEC0606C928W	28	1/16, 1/8	6	6	3	9.5	58	Without	AH725
MTEC0808C1419W	19	1/4, 3/8	8	8	3	14	64	Without	AH725
MTEC1212D1914W	14	1/2, 5/8, 3/4, 7/8	12	12	4	19.3	84	Without	AH725
MTEC1212D2614W	14	1/2, 5/8, 3/4, 7/8	12	12	4	26.3	84	Without	AH725
MTEC1212C2411W	11	≥ 1	12	12	3	24.2	84	Without	AH725
MTEC1616D3811W	11	≥ 1	16	16	4	38.1	105	Without	AH725

MTECB-W

Solid carbide internal and external threading endmill, with coolant hole, for G, BSP profile

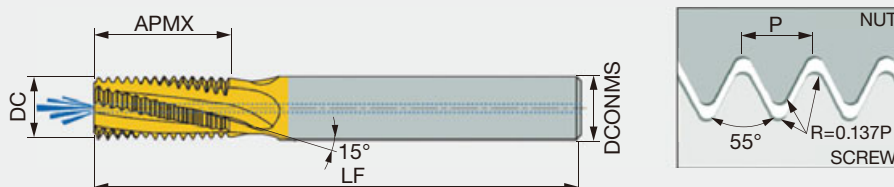

Designation	TPI	Application range	DCONMS	DC	NOF	APMX	LF	Coolant hole	Grade
MTECB08078C1428W	28	1/8	8	7.8	3	14.1	64	Without	AH725
MTECB1010D1619W	19	1/4, 3/8	10	10	4	16.7	73	Without	AH725
MTECB1616E2614W	14	1/2, 5/8, 3/4, 7/8	16	16	5	26.3	105	Without	AH725
MTECB1616D3811W	11	≥ 1	16	16	4	38.1	105	Without	AH725
MTECB2020E4711W	11	≥ 1	20	20	5	47.3	105	Without	AH725

MTECZ-W

Solid carbide internal and external threading endmill for through hole, with coolant hole, for G, BSP profile

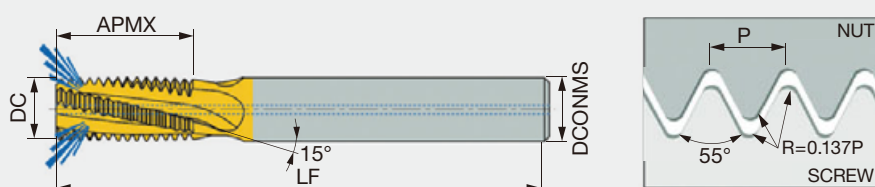

Designation	TPI	Application range	DCONMS	DC	NOF	APMX	LF	Coolant hole	Grade
MTECZ08078C1428W	28	1/8	8	7.8	3	14.1	64	With	AH725
MTECZ1010D1619W	19	1/4, 3/8	10	10	4	16.7	73	With	AH725
MTECZ1616E2614W	14	1/2, 5/8, 3/4, 7/8	16	16	5	26.3	101	With	AH725

Reference pages: Standard cutting conditions → **I120 - I122**

MTECS-W

Solid carbide internal and external threading endmill, short edge type, for G, BSP profile

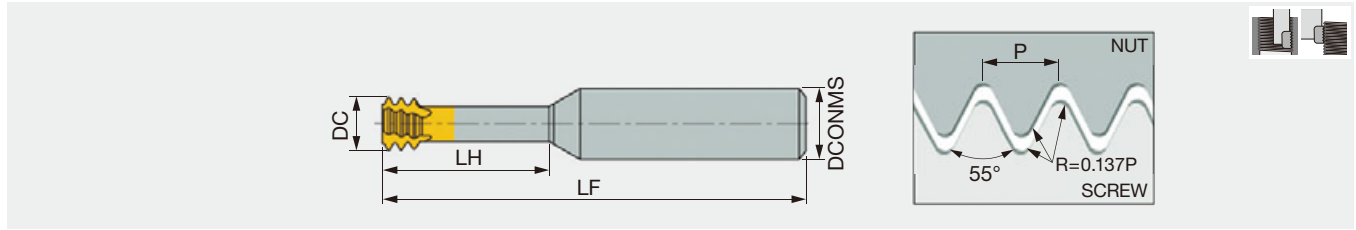

Designation	TPI	Application range	DCONMS	DC	NOF	LH	LF	Coolant hole	Grade
MTECS08078C1928W	28	1/8	8	7.8	3	19.5	64	Without	AH725
MTECS1010D3019W	19	1/4, 3/8	10	10	4	30	73	Without	AH725
MTECS1212D3714W	14	1/2, 5/8, 3/4, 7/8	12	12	4	37	84	Without	AH725

Tapered pipe thread (R, Rc, RT, BSPT)

MTEC-BSPT

Solid carbide internal and external threading endmill. for R, RC, BSPT profile

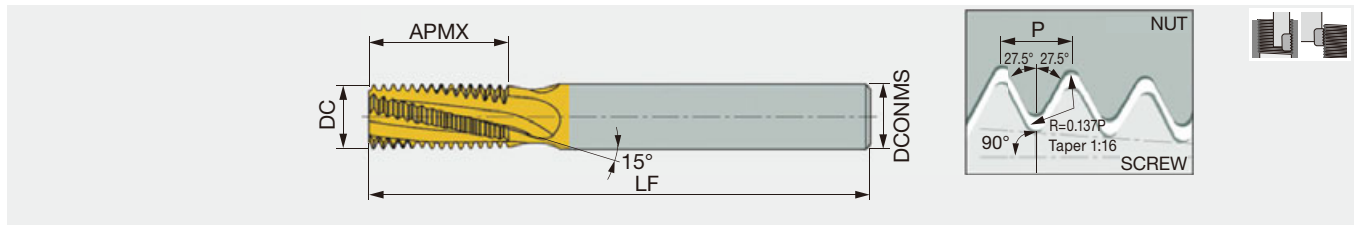

Designation	TPI	Application range	DCONMS	DC	NOF	APMX	LF	Coolant hole	Grade
MTEC0606C928BSPT	28	1/8	6	6	3	9.5	58	Without	AH725
MTEC0808C1419BSPT	19	1/4, 3/4	8	8	3	14	64	Without	AH725
MTEC1212D1914BSPT	14	1/2, 7/8	12	12	4	19.1	84	Without	AH725
MTEC1616D2811BSPT ⁽¹⁾	11	1, 1 1/4, 1 1/2, 2, 2 1/2	16	16	4	28.9	105	Without	AH725

(1) When the hole depth to be threaded exceeds APMX, use ETTL025M022W25.0F043R03-RT instead.

SOLIDTHREAD**NPT
MTEC-NPT**

Solid carbide internal and external threading endmill. for NPT profile

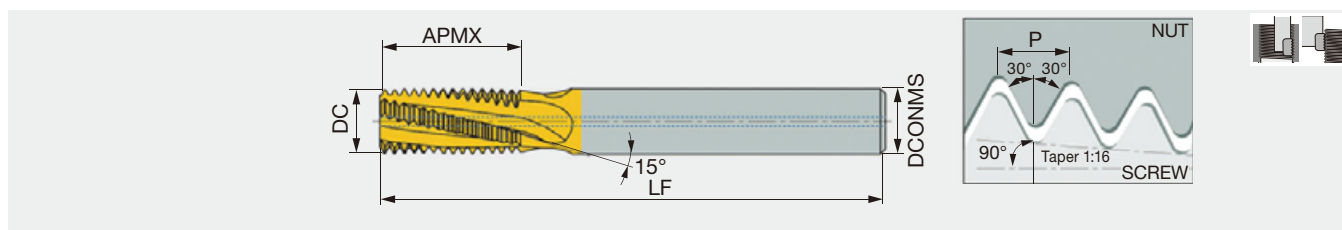

Designation	TPI	Application range	DCONMS	DC	NOF	APMX	LF	Coolant hole	Grade
MTEC0606C927NPT	27	1/16, 1/8	6	6	3	9.9	58	Without	AH725
MTEC0808C1418NPT	18	1/4, 3/8	8	8	3	14.8	64	Without	AH725
MTEC1212D2014NPT	14	1/2, 3/4	12	12	4	20.9	84	Without	AH725
MTEC1616D2711.5NPT	11.5	1, 1 1/4, 1 1/2, 2	16	16	4	27.6	105	Without	AH725
MTEC2020D398NPT ⁽¹⁾	8	2 1/2 - 6	20	20	4	39.7	105	Without	AH725

MTECB-NPT

Solid carbide internal and external threading endmill, with coolant hole, for NPT profile

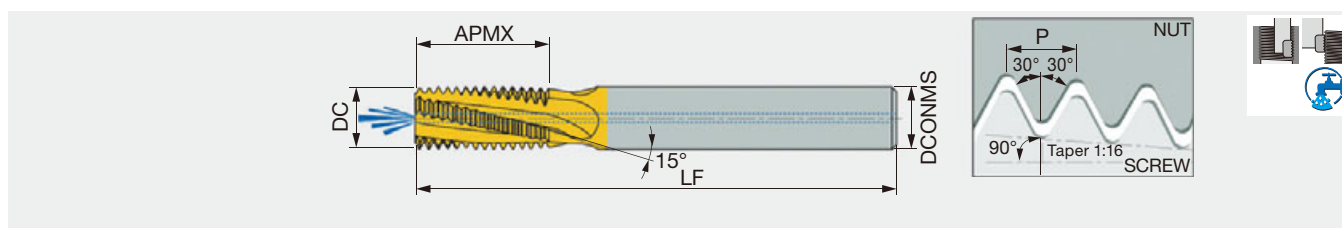

Designation	TPI	Application range	DCONMS	DC	NOF	APMX	LF	Coolant hole	Grade
MTECB08076C1027NPT	27	1/8	8	7.6	3	10.8	64	With	AH725
MTECB1010D1618NPT	18	1/4, 3/8	10	10	4	16.2	73	With	AH725
MTECB16155D2214NPT	14	1/2, 3/4	16	15.5	4	22.7	105	With	AH725

2

3

4

5

6

以上

NPTF**MTECZ-NPTF**

Solid carbide internal and external threading endmill for through hole, with coolant hole in the flute, for NPTF profile

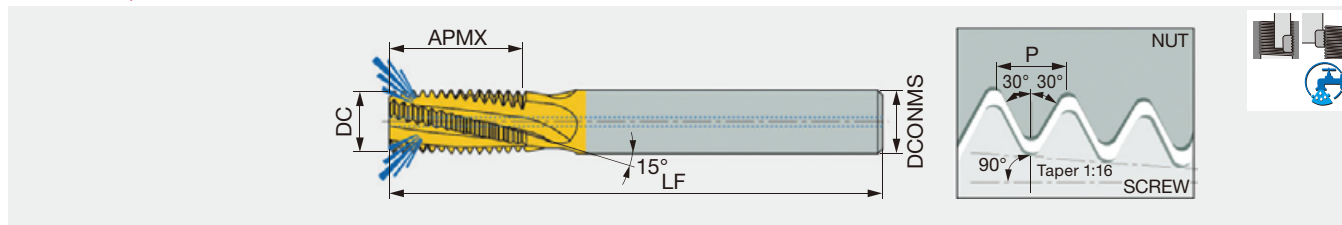

Designation	TPI	Application range	DCONMS	DC	NOF	APMX	LF	Coolant hole	Grade
MTECZ08076C1027NPTF	27	1/8	8	7.6	3	10.8	64	With	AH725
MTECZ1010D1618NPTF	18	1/4, 3/8	10	10	4	16.2	73	With	AH725

Reference pages: Standard cutting conditions → [I120 - I122](#)

MJ

MTECS-MJ

Small diameter solid carbide internal threading endmill, short edge type, with coolant hole, for MJ profile

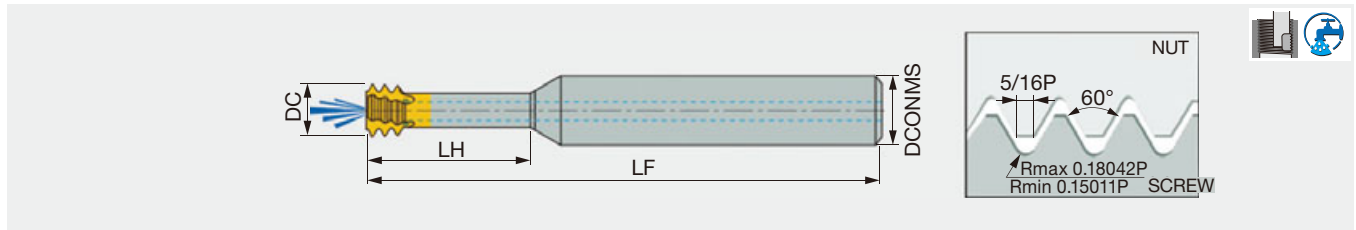

Designation	TP	Application range	DCONMS	DC	NOF	LH	LF	Coolant hole	Grade
MTECS06032C100.7MJ	0.7	≥ 4	6	3.2	3	10	58	Without	AH725
MTECS06039C120.8MJ	0.8	≥ 5	6	3.9	3	12.5	58	Without	AH725
MTECS06048C151.0MJ	1	≥ 6	6	4.8	3	15	58	Without	AH725
MTECS08061C201.25MJ	1.25	≥ 8	8	6.1	3	20	64	With	AH725
MTECS0808C251.5MJ	1.5	≥ 10	8	8	3	25	64	With	AH725
MTECS10092C301.75MJ	1.75	≥ 12	10	9.2	3	30	73	With	AH725
MTECS1010C352.0MJ	2	≥ 14	10	10	3	35	73	With	AH725

UNJ (UNJ, UNJC, UNJF, UNJEF)

MTECS-UNJ

Small diameter solid carbide internal threading endmill, short edge type, with coolant hole, for UNJ profile

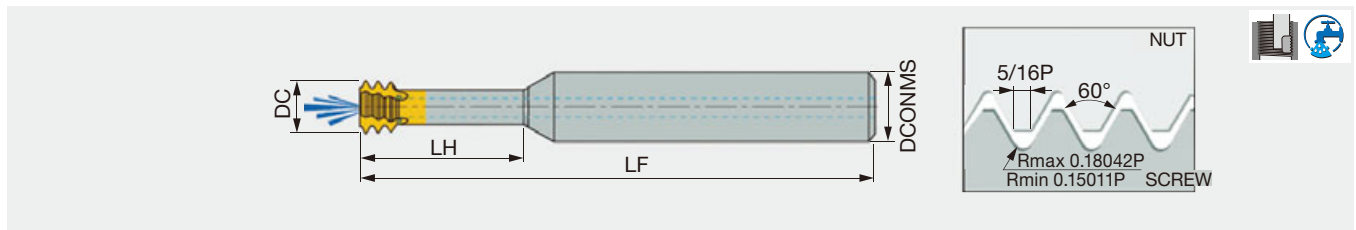

Designation	TPI	Application range	DCONMS	DC	NOF	LH	LF	Coolant hole	Grade
MTECS06033C1032UNJ	32	≥ #8	6	3.3	3	10.5	58	Without	AH725
MTECS08051C1628UNJ	28	≥ 1/4	8	5.1	3	16	64	With	AH725
MTECS08067C2024UNJ	24	≥ 5/16	8	6.7	3	20	64	With	AH725
MTECS06049C1620UNJ	20	≥ 1/4	6	4.9	3	16	58	Without	AH725
MTECS0808C2820UNJ	20	≥ 7/16	8	8	3	28	64	With	AH725
MTECS08061C2018UNJ	18	≥ 5/16	8	6.15	3	20	64	With	AH725
MTECS08069C2416UNJ	16	≥ 3/8	8	6.9	3	24	64	With	AH725
MTECS10094C2713UNJ	13	≥ 1/2	10	9.4	3	27.5	73	With	AH725

Reference pages: Standard cutting conditions → [I120 - I122](#)

THREADMILLING

STANDARD CUTTING CONDITIONS

ISO	Material	Condition	Tensile strength [N/mm ²]	Hardness HB	Cutting speed V _c (m/min)	
					AH725	
P	Non-alloy steel and cast steel, free cutting steel	< 0.25 %C	Annealed	420	125	100-250
		≥ 0.25 %C	Annealed	650	190	80-210
		< 0.55 %C	Quenched and tempered	850	250	65-170
		≥ 0.55 %C	Annealed	750	220	110-180
	Low alloy steel and cast steel (less than 5% of alloying elements)	Quenched and tempered	1000	300	95-160	
			600	200	90-160	
		Annealed	930	275	65-200	
			1000	300	70-210	
		1200	350	95-160		
			High alloyed steel, cast steel, and tool steel	Annealed	680	200
	Quenched and tempered	1100		325	75-100	
	Stainless steel and cast steel	Ferritic/martensitic	680	200	110-170	
Martensitic		820	240	70-155		
M	Stainless steel	Austenitic	600	180	85-100	
K	Cast iron nodular (GGG)	Ferritic/martensitic	180	120-160		
		Pearlitic	260	75-160		
	Grey cast iron (GG)	Ferritic	160	70-150		
		Pearlitic	250	110-140		
	Malleable cast iron	Ferritic	130	120-160		
Pearlitic	230	110-140				
N	Aluminum- wrought alloy	Not cureable	60	160-300		
		Cured	100			
	Aluminum-cast, alloyed	≤12% Si	Not cureable	75	150-350	
		Cured	90			
		>12% Si	High temperature	130	100-250	
	Copper alloys	>1% Pb	Free cutting	110		
		Brass	90			
Non-metallic	Electrolitic copper	100				
	Duroplastics, fiber plastics		100-400			
S	High temp. alloys	Fe based	Annealed	200		
			Cured	280		
		Ni or Co based	Annealed	250	20-80	
			Cured	350		
	Titanium Ti alloys	Cast	320			
		RM 400				
Alpha+beta alloys cured	RM 1050	20-80				
H	Hardened steel	Hardened	55 HRC	55-65		
		Hardened	60 HRC	45-55		
	Chilled cast iron	Cast	400	90-105		
	Cast iron	Hardened	55 HRC	55-65		



Tool dia.: DC (mm)											
Feed: f (mm/t)											
ø2	ø3	ø4	ø6	ø8	ø10	ø12	ø14	ø16	ø20	ø25	ø30
0.03	0.04	0.04	0.06	0.07	0.08	0.09	0.11	0.12	0.15	0.18	0.21
0.03	0.04	0.04	0.06	0.07	0.08	0.09	0.11	0.12	0.15	0.18	0.21
0.02	0.03	0.03	0.05	0.06	0.07	0.08	0.09	0.1	0.12	0.15	0.18
0.02	0.03	0.03	0.05	0.06	0.07	0.08	0.09	0.1	0.12	0.15	0.18
0.02	0.02	0.03	0.03	0.04	0.05	0.05	0.06	0.07	0.08	0.1	0.11
0.02	0.02	0.03	0.03	0.04	0.05	0.05	0.06	0.07	0.08	0.1	0.11
0.02	0.02	0.03	0.03	0.04	0.05	0.05	0.06	0.07	0.08	0.1	0.11
0.02	0.02	0.03	0.03	0.04	0.05	0.05	0.06	0.07	0.08	0.1	0.11
0.02	0.02	0.03	0.03	0.04	0.05	0.05	0.06	0.07	0.08	0.1	0.11
0.02	0.02	0.03	0.03	0.04	0.05	0.05	0.06	0.07	0.08	0.1	0.11
0.02	0.02	0.03	0.03	0.04	0.05	0.05	0.06	0.07	0.08	0.1	0.11
0.02	0.02	0.03	0.03	0.04	0.05	0.05	0.06	0.07	0.08	0.1	0.11
0.02	0.02	0.03	0.03	0.04	0.05	0.05	0.06	0.07	0.08	0.1	0.11
0.03	0.04	0.04	0.06	0.07	0.08	0.09	0.11	0.12	0.15	0.18	0.21
0.03	0.04	0.04	0.06	0.07	0.08	0.09	0.11	0.12	0.15	0.18	0.21
0.03	0.04	0.04	0.06	0.07	0.08	0.09	0.11	0.12	0.15	0.18	0.21
0.03	0.04	0.04	0.06	0.07	0.08	0.09	0.11	0.12	0.15	0.18	0.21
0.03	0.04	0.04	0.06	0.07	0.08	0.09	0.11	0.12	0.15	0.18	0.21
0.03	0.04	0.04	0.06	0.07	0.08	0.09	0.11	0.12	0.15	0.18	0.21
0.03	0.04	0.04	0.06	0.07	0.08	0.09	0.11	0.12	0.15	0.18	0.21
0.02	0.02	0.03	0.03	0.04	0.05	0.05	0.06	0.07	0.08	0.10	0.12
0.05	0.06	0.07	0.09	0.1	0.11	0.12	0.13	0.15	0.18	0.22	0.25
0.02	0.02	0.02	0.03	0.03	0.03	0.03	0.04	0.04	0.04	0.05	0.05
0.02	0.02	0.02	0.03	0.03	0.03	0.03	0.04	0.04	0.04	0.05	0.05

When using long edge type tools, Feed should be reduced to 40% of above table.

THREADMILLING

MTECS

Small Diameter, Short edge type

Thread Milling - Procedure

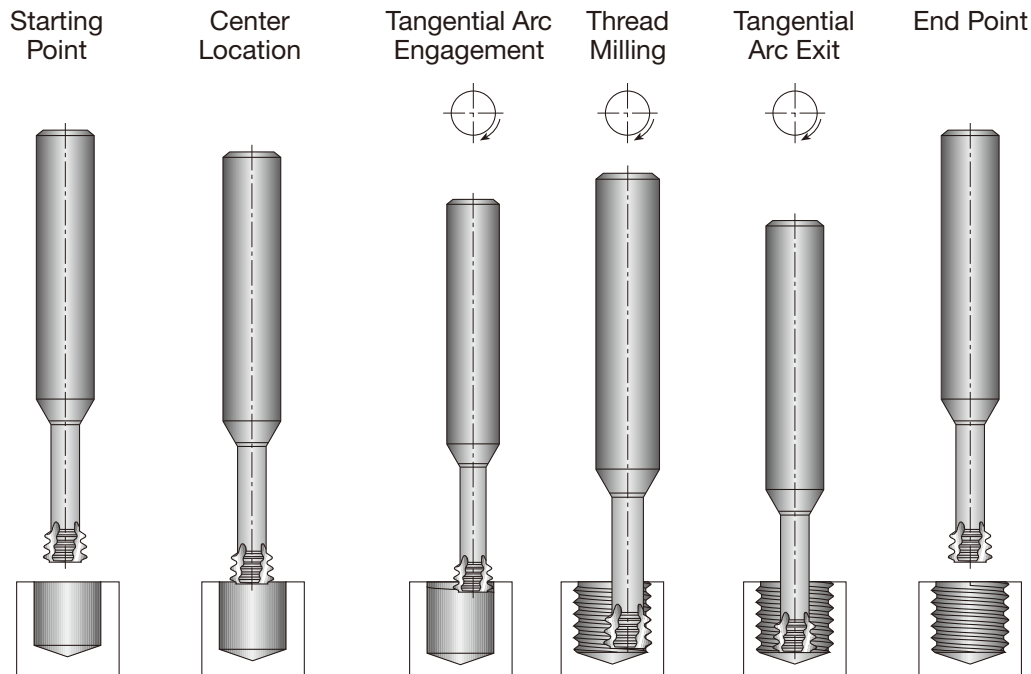

STANDARD CUTTING CONDITIONS

ISO	Material	Cutting speed V_c (m/min)	Feed: f (mm/t)												
			$\phi 1.5$	$\phi 2$	$\phi 3$	$\phi 4$	$\phi 5$	$\phi 6$	$\phi 7$	$\phi 8$	$\phi 9$	$\phi 10$	$\phi 12$	$\phi 14$	$\phi 15$
P	Low & medium carbon steels	60-120	0.05	0.05	0.07	0.09	0.11	0.13	0.14	0.15	0.16	0.16	0.17	0.18	0.18
	High carbon steels	60-90	0.04	0.05	0.06	0.08	0.09	0.1	0.12	0.13	0.14	0.14	0.16	0.17	0.18
	Alloy steels, treated steels	50-80	0.04	0.04	0.05	0.05	0.06	0.07	0.07	0.08	0.09	0.1	0.12	0.13	0.14
	Cast steels	70-90	0.04	0.04	0.05	0.05	0.06	0.07	0.07	0.08	0.09	0.1	0.12	0.13	0.14
M	Stainless steels	60-90	0.03	0.03	0.04	0.05	0.06	0.06	0.07	0.08	0.09	0.1	0.11	0.12	0.13
K	Cast iron	40-80	0.05	0.05	0.07	0.09	0.11	0.13	0.14	0.15	0.16	0.16	0.17	0.18	0.18
N	Aluminum	80-150	0.05	0.05	0.07	0.09	0.11	0.13	0.14	0.15	0.16	0.16	0.17	0.18	0.18
	Synthetics, duroplastics, thermoplastics	50-200	0.1	0.11	0.12	0.14	0.16	0.18	0.19	0.19	0.19	0.19	0.19	0.2	0.2
S	Nickel alloys, titanium alloys	20-40	0.03	0.03	0.04	0.04	0.05	0.06	0.06	0.06	0.07	0.07	0.07	0.08	0.08

MTECS Small Diameter, Short edge type

SolidThread MTECS is used for the production of small internal threads. These thread mills feature a short 3-tooth cutting zone with 3 flutes and a released neck between the cutting zone and the shank. This unique tool design offers very precise profiles and a high performance AH725 submicron carbide grade with PVD titanium aluminum nitride coating. The very short profile exerts a low force which minimizes tool bending. This facilitates parallel and high thread precision for the entire length.



Compared to taps, the **SOLIDTHREAD** is more accurate, thread machining is substantially faster and there is no danger of a broken tap being stuck in the hole.

SolidThread vs. Tap

Criteria	Thread mill	Taps
Thread surface quality	High	Medium
Thread geometry	Very accurate	Medium
Thread tolerance	4H, 5H, 6H with std. cutter	6H with standard tap, 4H with special tap
Machining time	Shorter or same as tap	Short
Machining load	Very low	High
Range of thread diameters	Wide range of diameters (able to thread a wide range of hole sizes)	Specific tap for each thread size
Right-/Left-hand threading	Same cutter	Specific tap for right- and left-hand

Features

- Minimum thread size of MTECS: **M1x0.25** (0.75 mm pre hole diameter) up to M20x2.50
- 2xD and 3xD threading lengths
- High cutting speeds
- Short cycle time
- Low cutting forces due to the short contact profile resulting in accurate and parallel thread
- Prevents oval threads near thin walls
- No more dealing with broken taps
- Reliable threading in blind holes
- Excellent performance on hardened steel, high temperature alloys and titanium



THREADMILLING

Thread milling cutter

Indexable thread milling cutter, long edge type

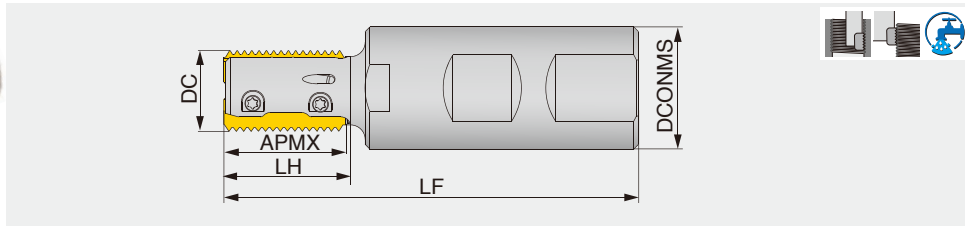

Designation	DC	APMX	CICT	DCONMS	LH	LF	Oil hole	Insert
ETTL25M017W25.0F026R02 ⁽¹⁾	17	25	2	25	26	85	with	TL25D...
ETTL25M017W25.0F036R02 ⁽¹⁾	17	25	2	25	36	95	with	TL25D...
ETTL25M019W25.0F032R02	19	25	2	25	32	92	with	TL25D...
ETTL25M019W25.0F044R02	19	25	2	25	44	104	with	TL25D...
ETTL25M021W25.0F037R03	20.5	25	3	25	37	96	with	TL25D...
ETTL25M021W25.0F044R03	20.5	25	3	25	44	103	with	TL25D...
ETTL25M022W25.0F043R03	22	25	3	25	43	102	with	TL25D...
ETTL25M022W25.0F055R03	22	25	3	25	55	114	with	TL25D...
ETTL25M030W25.0F055R05	30	25	5	25	55	115	with	TL25D...

(1) Inserts with a thread pitch of ≥ 3 mm or ≥ 9 TPI are not mountable.

SPARE PARTS

Designation	Clamping screw	Wrench
ETTL25...	SSTM4-3.6P	T-8D

INSERT

TL25D...

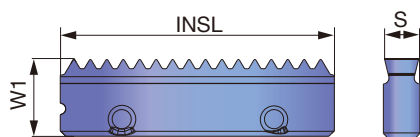

P	Steel	★	
M	Stainless	☆	
K	Cast iron	☆	
N	Non-ferrous	☆	
S	Superalloys	★	
H	Hard materials	★	

★ : First choice
☆ : Second choice

Thread type	Application	Designation	Pitch	Threads per inch	Number of threads per edge	Coated		INSL	W1	S	Applicable thread sizes for the given cutter diameters: DC (mm)				
						AH725					ø17	ø19	ø20.5	ø22	ø30
ISO Metric	Internal	TL25DIR1.5ISO	1.5	-	16	●		25	7	3.1	≥ M19	≥ M21	≥ M23	≥ M24	≥ M32
		TL25DIR2.0ISO	2	-	12	●		25	7	3.1	≥ M20	≥ M22	≥ M23	≥ M25	≥ M33
		TL25DIR3.0ISO ⁽²⁾	3	-	8	●		25	7	3.1	-	≥ M23	≥ M25	≥ M26	≥ M34
Unified	Internal	TL25DIR20UN	-	20	19	●		25	7	3.1	≥ 3/4	≥ 7/8	≥ 7/8	≥ 15/16	≥ 15/16
		TL25DIR12UN	-	12	11	●		25	7	3.1	≥ 13/16	≥ 7/8	≥ 15/16	≥ 1	≥ 15/16
		TL25DIR9UN ⁽²⁾	-	9	8	●		25	7	3.1	-	≥ 7/8	≥ 15/16	≥ 1	≥ 13/8
		TL25DIR8UN ⁽²⁾	-	8	7	●		25	7	3.1	-	≥ 15/16	≥ 1	≥ 11/16	≥ 13/8
Whitworth (parallel pipe)	Internal and external	TL25DEIR14W	-	14	13	●		25	7	3.1	≥ G1/2	≥ G5/8	≥ G3/4	≥ G3/4	-
		TL25DEIR11W	-	11	10	●		25	7	3.1	≥ G1	≥ G1	≥ G1	≥ G1	≥ G1

Do not use this tool when the hole depth to be threaded exceeds the cutter's LH value.

(2) Does not fit the DC = 17 mm holder

● : Line up

Reference pages: Standard cutting conditions → [I127](#)

Thread milling cutter

Indexable thread milling cutter, long edge type

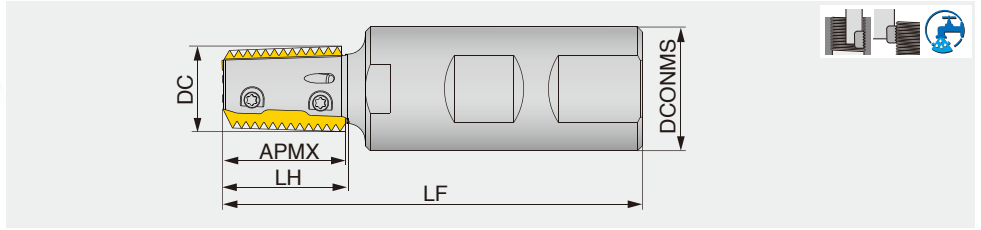

Designation	DC	APMX	CICT	DCONMS	LH	LF	Oil hole	Insert
ETTL25M017W25.0F026R02-PT	17.47	25	2	25	25.5	85	with	TL25SEIR...
ETTL25M022W25.0F043R03-PT	22.2	25	3	25	43	102	with	TL25SEIR...

SPARE PARTS

Designation	Clamping screw	Wrench
ETTL...-PT	SSTM4-3.6P	T-8D

Excellent surface finish

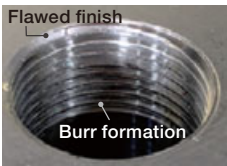

Helical tap
(of HSS)

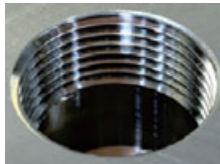

THREADMILLING
ETTL25M017W25.0F026R02-PT,
TL25SEIR11BSPT

Machine: BT50
Thread: Rc1

INSERT

TL25SEIR...

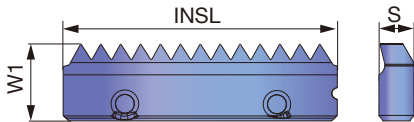

P	Steel	★
M	Stainless	☆
K	Cast iron	☆
N	Non-ferrous	☆
S	Superalloys	★
H	Hard materials	★

★ : First choice
☆ : Second choice

Thread type	Application	Designation	Pitch	Threads per inch	Number of threads per edge	Coated		INSL	W1	S	Applicable thread sizes for the given cutter diameters: DC (mm)	
						AH725					ø17.47	ø22.2
BSPT	Internal and external	TL25SEIR14BSPT	-	14	13	●		25	7	3.1	1/2, 3/4	3/4
		TL25SEIR11BSPT	-	11	10	●		25	7	3.1	≥ 1 ⁽¹⁾	≥ 1 ⁽¹⁾
NPT	Internal and external	TL25SEIR14NPT	-	14	13	●		25	7	3.1	1/2, 3/4	3/4
		TL25SEIR11.5NPT	-	11.5	11	●		25	7	3.1	1, 1 1/4, 1 1/2, 2 ⁽¹⁾	1, 1 1/4, 1 1/2, 2 ⁽¹⁾
NPTF	Internal and external	TL25SEIR14NPTF	-	14	13	●		25	7	3.1	1/2, 3/4	3/4

(1) Do not use this insert when the hole depth to be threaded exceeds the cutter's LH.

●: Line up

THREADMILLING

Thread milling cutter

Indexable thread milling cutter, long edge type

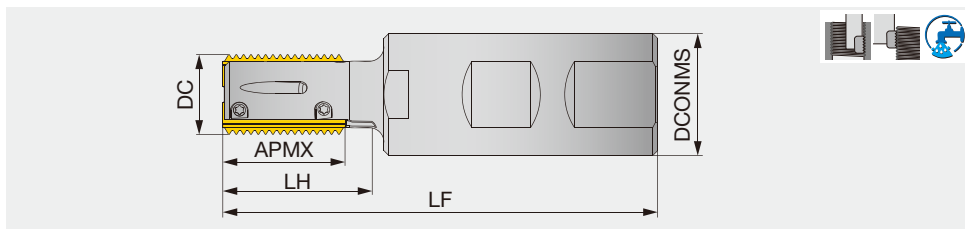

Designation	DC	APMX	CICT	DCONMS	LH	LF	Coolant hole	Insert
ETLN25M017W25.0F026R02 ⁽¹⁾	17	25	2	25	26	85	With	LN25....
ETLN25M017W25.0F036R02 ⁽¹⁾	17	25	2	25	36	95	With	LN25....
ETLN25M019W25.0F032R02	19	25	2	25	32	92	With	LN25....
ETLN25M019W25.0F044R02	19	25	2	25	44	104	With	LN25....
ETLN25M021W25.0F037R03	20.5	25	3	25	37	96	With	LN25....
ETLN25M021W25.0F044R03	20.5	25	3	25	44	103	With	LN25....
ETLN25M022W25.0F043R03	22	25	3	25	43	102	With	LN25....
ETLN25M022W25.0F055R03	22	25	3	25	55	114	With	LN25....
ETLN25M030W25.0F055R05	30	25	5	25	55	115	With	LN25....

(1) Inserts with a thread pitch of ≥ 3 mm or ≥ 8 TPI do not fit.

SPARE PARTS



Designation	Clamping screw	Wrench
ETLN25...	SSTM3-3	T-6F

Recommended clamping torque: 1 N·m

INSERT

LN25...

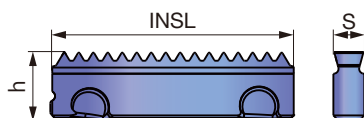

Material	Symbol	Coated
P Steel	★	●
M Stainless	☆	●
K Cast iron	☆	●
N Non-ferrous	☆	●
S Superalloys	★	●
H Hard materials	★	●

★ : First choice
☆ : Second choice

Thread type	Application	Designation	Pitch	Threads per inch	Coated			INSL	h	S
					AH725					
ISO Metric	Internal	LN25DIR1.5ISO	1.5	-	●	●	●	25	7	3.1
		LN25DIR2.0ISO	2	-	●	●	●	25	7	3.1
		LN25DIR3.0ISO ⁽²⁾	3	-	●	●	●	25	7	3.1
Unified	Internal	LN25DIR20UN	-	20	●	●	●	25	7	3.1
		LN25DIR12UN	-	12	●	●	●	25	7	3.1
		LN25DIR8UN ⁽²⁾	-	8	●	●	●	25	7	3.1
Whitworth	Internal and external	LN25DEIR14W	-	14	●	●	●	25	7	3.1
		LN25DEIR11W	-	11	●	●	●	25	7	3.1

(2) Does not fit the DC 17 holder

●: Line up

Reference pages: Standard cutting conditions → [I127](#)

STANDARD CUTTING CONDITIONS

ISO	Workpiece material	Grades	Cutting speed V_c (m/min)	Feed per tooth f_z (mm/t)
P	Low carbon steel	AH725	100 - 200	0.1 - 0.3
	High carbon steel	AH725	70 - 150	0.1 - 0.3
	High carbon steels	AH725	70 - 170	0.1 - 0.3
	Cast steel	AH725	70 - 170	0.1 - 0.3
M	Stainless steel	AH725	90 - 140	0.1 - 0.3
K	Cast iron	AH725	60 - 130	0.05 - 0.3
N	Aluminium alloys	AH725	80 - 400	0.1 - 0.4
S	Heat-resistant alloys	AH725	10 - 30	0.02 - 0.1
	Titanium alloy	AH725	20 - 90	0.02 - 0.1

Climb milling is recommended.

Insert installation

1. Use airgun or rag to thoroughly clean all the insert pockets free from dust or chips.
2. Lightly tighten Screw "A" first, then Screw "B" until the insert becomes stationary.
3. Lightly tighten the screws for other insert(s) in the same matter as mentioned in #1 and #2 above.
4. Firmly tighten Screw "A", then Screw "B".
Use the recommended torque strengths when tightening the screws.
5. Firmly tighten the screws for other insert(s) in the same manner as mentioned in #4 above.
6. Inspect to make sure there is no gap between the insert and the insert seat. Measure the radial runout before use.

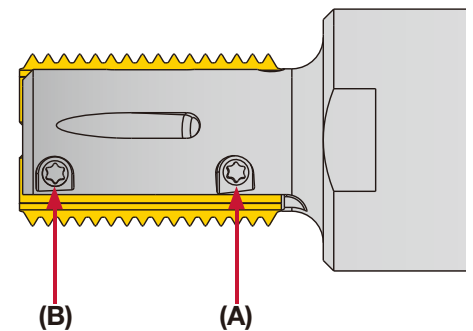

THREADMILLING

Thread milling cutter

Indexable thread milling cutter, single tooth

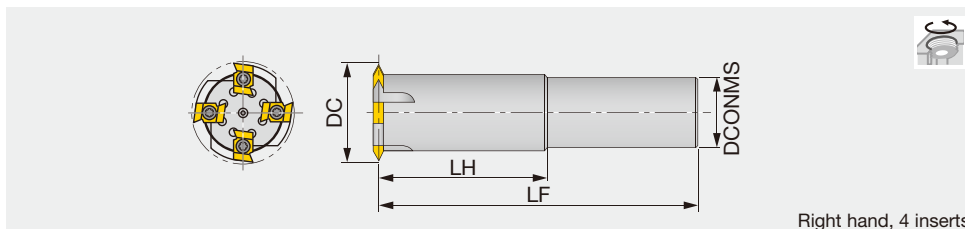

Right hand, 4 inserts

Designation	DC	CICT	DCONMS	LH	LF	Range of internal thread	Insert
D23-D25-45R	23	1	25	45	115	M28 - M30	T1-R...
D25-D25-45R	25	1	25	45	115	M32 - M42	T1-R...
D38-D32-85R	38	2	32	85	165	M45 - M56	T1-R...
D50-D42-100R	50	4	42	100	190	M58 - M68	T1-R...
D55-D42-100R	55	4	42	100	190	M64 - M85	T2-R...
D60-D42-100R	60	4	42	100	190	M70 - M85	T2-R...
D80-D42-100R	80	6	42	100	190	M90 -	T2-R...

SPARE PARTS



Designation	Clamping screw	Wrench
D23-D25... - D50-D42...	CSTB-4	T-15F
D55-D42... - D80-D42...	CSTB-5	T-20F

Recommended clamping torque: CSTB-4 = 3.5 N·m, CSTB-5 = 5 N·m

INSERT

T*-R...

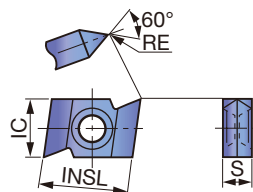

	P	M	K	N	S	H
Steel	★					
Stainless	★					
Cast iron						
Non-ferrous						
Superalloys						
Hard materials						

★ : First choice
☆ : Second choice

Designation	RE	Coated							INSL	IC	S
		GH330									
T1-R14	0.14	●							14.4	9.525	4.76
T1-R28	0.28	●							14.4	9.525	4.76
T2-R14	0.14	●							17.8	12.7	6.35
T2-R28	0.28	●							17.8	12.7	6.35

● : Line up

Reference pages: Standard cutting conditions → I129

STANDARD CUTTING CONDITIONS

ISO	Workpiece material	Hardness	Grades	Cutting speed V _c (m/min)	Feed per tooth f _z (mm/t)
P	Mild steels , Unhardened steels	≥ 200 HB	GH330	150 - 200	0.3 - 0.4
	Carbon steels, Alloy steels	≥ 300 HB	GH330	150 - 200	0.17 - 0.26
	Die steels	≥ 50 HRC	GH330	30 - 50	0.14 - 0.2
M	Stainless steels	≥ 300 HB	GH330	150 - 200	0.05 - 0.12

Climb milling is recommended.

When threading a blind hole, use the right hand cutter in right-hand rotation. Cut up from the bottom to prevent chip recutting.

THREADING MILLS AND APPLICABLE THREADS

Internal threading - Metric threads (M)

Designation	Insert	Pitch (mm)										
		1.5	1.75	2	2.5	3	3.5	4	4.5	5	5.5	6
D23-D25-45R	T1-R14	M28	M28	M29	M29	M30	M30	-	-	-	-	-
	T1-R28	-	-	-	-	M30	M30	-	-	-	-	-
D25-D25-45R	T1-R14	M30	M30	M31	M31	M32	M32	M36	M36	-	-	-
	T1-R28	-	-	-	-	M32	M32	M36	M36	-	-	-
D38-D32-85R	T1-R14	M43	M43	M44	M44	M45	M45	M46	M46	M48	M56	-
	T1-R28	-	-	-	-	M45	M45	M46	M46	M48	M56	-
D50-D42-100R	T1-R14	M55	M55	M56	M56	M57	M57	M58	M58	M59	M59	-
	T1-R28	-	-	-	-	M57	M57	M58	M58	M59	M59	-
D55-D42-100R	T2-R14	M60	M60	M61	M61	M62	M62	M63	M63	M64	M64	M65
	T2-R28	-	-	-	-	M62	M62	M63	M63	M64	M64	M65
D60-D42-100R	T2-R14	M65	M65	M66	M66	M67	M67	M68	M68	M69	M69	M70
	T2-R28	-	-	-	-	M67	M67	M68	M68	M69	M69	M70
D80-D42-100R	T2-R14	M85	M85	M86	M86	M87	M87	M88	M88	M89	M89	M90
	T2-R28	-	-	-	-	M87	M87	M88	M88	M89	M89	M90

Internal threading - Unified threads (UN, UNC, UNF, UNEF)

Designation	Insert	TPI												
		16	14	13	12	11	10	9	8	7	6	5	4.5	4
D23-D25-45R	T1-R14	1 1/8	1 1/8	1 1/8	1 1/8	1 1/8	1 3/16	1 3/16	1 3/16	1 3/16	-	-	-	-
	T1-R28	-	-	-	-	-	1 3/16	1 3/16	1 3/16	1 3/16	-	-	-	-
D25-D25-45R	T1-R14	1 3/16	1 3/16	1 3/16	1 1/4	1 1/4	1 1/4	1 1/4	1 1/4	1 5/16	1 3/8	1 3/4	-	-
	T1-R28	-	-	-	-	-	1 1/4	1 1/4	1 1/4	1 5/16	1 3/8	1 3/4	-	-
D38-D32-85R	T1-R14	1 11/16	1 3/4	1 3/4	1 3/4	1 3/4	1 3/4	1 3/4	1 3/4	1 13/16	1 13/16	1 7/8	2	-
	T1-R28	-	-	-	-	-	1 3/4	1 3/4	1 3/4	1 13/16	1 13/16	1 7/8	2	-
D50-D42-100R	T1-R14	2 1/4	2 1/4	2 1/4	2 1/4	2 1/4	2 1/4	2 1/4	2 1/4	2 1/4	2 3/8	2 3/8	2 3/8	-
	T1-R28	-	-	-	-	-	2 1/4	2 1/4	2 1/4	2 1/4	2 3/8	2 3/8	2 3/8	-
D55-D42-100R	T2-R14	2 3/8	2 3/8	2 3/8	2 3/8	2 1/2	2 1/2	2 1/2	2 1/2	2 1/2	2 1/2	2 5/8	2 5/8	2 3/4
	T2-R28	-	-	-	-	-	2 1/2	2 1/2	2 1/2	2 1/2	2 1/2	2 5/8	2 5/8	2 3/4
D60-D42-100R	T2-R14	2 5/8	2 5/8	2 5/8	2 5/8	2 5/8	2 5/8	2 5/8	2 5/8	2 3/4	2 3/4	2 3/4	2 7/8	3
	T2-R28	-	-	-	-	-	2 5/8	2 5/8	2 5/8	2 3/4	2 3/4	2 3/4	2 7/8	3
D80-D42-100R	T2-R14	3 3/8	3 3/8	3 3/8	3 3/8	3 3/8	3 1/2	3 1/2	3 1/2	3 1/2	3 1/2	3 1/2	3 5/8	3 3/4
	T2-R28	-	-	-	-	-	3 1/2	3 1/2	3 1/2	3 1/2	3 1/2	3 1/2	3 5/8	3 3/4

Milling Insert (Old item)

● ACMT**PR-MJ

Shape	Designation	Coated									Applicable mill
		AH120	AH140	GH330	T3130						
 Rake angle Land width -MJ	ACMT060308PR-MJ	●	●	●	●						ELP07/09/12... (old item)
	ACMT07T308PR-MJ	●	●	●	●						
	ACMT100408PR-MJ	●	●	●	●						

● ADMT**PR-MJ

Shape	Designation	Coated								Applicable mill
		AH120	AH140	T3130						
 Rake angle Land width -MJ	ADMT130308PR-MJ	●	●	●						ELP13/17/21... (old item)
	ADMT17T308PR-MJ	●	●	●						
	ADMT210408PR-MJ	●	●	●						

● AECW**PEFR, AECW**PESR, AEMW**PEFR, AEMW**PETR

Shape	Designation	Coated		Cermet	Uncoated					Applicable mill
		AH120	GH330		NS740	UX30				
	AECW1403PEFR					●				EPE4000/5000/ 6000... (old item)
	AECW1403PESR	●	●	●		●				
	AECW16T3PEFR					●				
	AECW16T3PESR	●	●	●		●				
	AECW1804PEFR					●				
	AECW1804PESR	●	●	●		●				
	AEMW1403PEFR					●				
	AEMW1403PETR		●	●		●				
	AEMW16T3PEFR					●				
	AEMW16T3PETR		●	●		●				
	AEMW1804PEFR					●				
AEMW1804PETR		●	●	●	●					

● ANEA542TN, ANEA642TN

Shape	Designation	Uncoated								Applicable mill
		UX30								
	ANEA542TN	●								VSN... (old item)
	ANEA642TN	●								

●: Line up

Milling Insert (Old item)

Grade

Insert

Ext. Toolholder

Int. Toolholder

Threading

Grooving

Miniature tool

Milling cutter

Endmill

Drilling tool

Tooling System

User's Guide

Index



● ANMT**PPPR-MJ, ANMT**PPPR-ML

Shape	Designation	Coated			Applicable mill
		AH120	GH330	T3130	
 -MJ	ANMT09T3PPPR-MJ	●	●	●	EPN09 (old item) EPN14... TPN14... (old item)
	ANMT09T3PPPR-ML	●			
	ANMT1404PPPR-MJ	●	●	●	
	ANMT1404PPPR-ML	●			
 -ML					

● APMT**PN-MJ

Shape	Designation	Coated				Applicable mill
		AH120	AH140	GH330	T3130	
 -MJ	APMT070308PN-MJ	●	●	●	●	ELP07/09/12... (old item)
	APMT09T308PN-MJ	●	●	●	●	
	APMT120408PN-MJ	●	●	●	●	

● ASMT17**PDPR-MJ, ASGT17**PDFR-AJ, ASMT170508PDPR-MS

Shape	Designation	Coated					Cermet	Uncoated	Applicable mill
		AH120	AH130	AH140	T1115	T3130	DS1100	NS740	
 -MJ	ASMT170504PDPR-MJ	●			●	●			TPS17... (old item) EPS17... (old item)
	ASMT170508PDPR-MJ	●			●	●			
	ASMT170512PDPR-MJ	●				●			
	ASMT170516PDPR-MJ	●				●	●		
	ASMT170520PDPR-MJ	●				●			
	ASMT170530PDPR-MJ	●				●	●		
 -MS	ASMT170532PDPR-MJ	●				●			
	ASMT170508PDPR-MS		●	●					
 -AJ	ASGT170504PDFR-AJ						●		
	ASGT170508PDFR-AJ							●	

●: Line up

Milling Insert (Old item)

● CPMW**-EN, CPMT**-EN

Shape	Designation	Coated					Uncoated					Applicable mill
		AH120	AH140	AH330	T3130	DS1100	UX30	TH10				
	CPMW050208EN	●					●					EVP1000 (old item)
	CPMW06T208EN	●					●					
	CPMT080308EN	●					●					







● EDKW53ZTR

Shape	Designation	Coated					Uncoated					Applicable mill
		AH120	AH140	AH330	T3130	DS1100	UX30	TH10				
	EDKW53ZTR	●					●					ESD5000 (old item)

● ENEQ**TN-T

Shape	Designation	Coated					Uncoated					Applicable mill
		AH120	AH140	AH330	T3130	DS1100	UX30	TH10				
	ENEQ090508TN-T	●										VSNE09... (old item)
	ENEQ100508TN-T	●										VSNE10... (old item)
	ENEQ130608TN-T	●										VSNE13... (old item)
	ENEQ160608TN-T	●										VSNE16... (old item)

● GDMT**PDPR-MJ, GDGT**PDFR-AJ

Shape	Designation	Coated					Uncoated							Applicable mill
		AH120	AH140	AH330	T3130	DS1100	UX30	TH10						
     	GDMT10H3PDPR-MJ	●	●	●	●		●						TSD10/17... (old item)	
	GDMT17X6PDPR-MJ	●	●	●	●		●							ESD10/17... (old item)
	GDGT10H3PDFR-AJ					●		●						HSD10/17... (old item)
	GDGT17X6PDFR-AJ					●		●						

● HEHN532FN

Shape	Designation	Uncoated										Applicable mill	
		AH120	AH140	AH330	T3130	DS1100	UX30	TH10					
	HEHN532FN	●											QYE5300 (old item)

●: Line up

Milling Insert (Old item)

Grade
Insert
Ext. Toolholder
Int. Toolholder
Threading
Grooving
Miniature tool
Milling cutter
Endmill
Drilling tool
Tooling System
User's Guide
Index

A
B
C
D
E
F
G
H
I
J
K
L
M

● HPKN532FN

Shape	Designation	Uncoated					Applicable mill
		TH10					
	HPKN532FN	●					QYP5300 (old item)

● LNCA64ZTR

Shape	Designation	Coated		Uncoated			Applicable mill
		T3130		UX30			
	LNCA64ZTR	●		●			VSN6000I (old item)



● RDCA2004TN, RDCN2004TN, RDKN2004...

Shape	Designation	Coated		Uncoated		Applicable mill
		AH120		UX30	TH10	
	RDCA2004TN			●		TRD6000 (old item)
	RDCN2004TN			●		
	RDKN2004FN				●	ERD6000 (old item)
	RDKN2004TN	●		●		

● RDCM1203TN, RDMA1203TN

Shape	Designation	Uncoated					Applicable mill
		UX30					
	RDCM1203TN	●					ERD4000 (old item)
	RDMA1203TN	●					

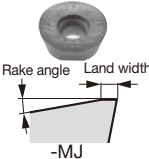
● RDMT**ZDPN-MJ, RDMW**ZDSN

Shape	Designation	Coated					Uncoated		Applicable mill
		AH120	AH130	AH140	AH330	T3130	UX30		
 <p>Rake angle Land width -MJ</p> 	RDMT1204ZDPN-MJ	●		●	●	●	●	TRD12/16... (old item)	
	RDMW1204ZDSN	●		●	●	●	●		
	RDMT1606ZDPN-MJ	●	●	●	●	●	●	ERD12/16... (old item)	
	RDMW1606ZDSN	●		●	●	●			

●: Line up

Milling Insert (Old item)

● RFEN2004ZFTN, RFEN2004M0TN

Shape	Designation	Coated		Uncoated		Applicable mill
		AH120	GH330	UX30	KS20	
	RFEN2004ZFTN	●	●	●	●	TRF6000 (old item)
	RFEN2004M0TN		●	●	●	ERF6000 (old item)

● SDCN1504ZDSR, SDEN1504ZDSR, SDNN1504ZDSR

Shape	Designation	Coated				Applicable mill
		AH120	AH140	T1115	T3130	
	SDCN1504ZDSR	●	●		●	MILLFEED TXD15... (old item)
	SDEN1504ZDSR	●	●	●	●	
	SDNN1504ZDSR	●	●	●	●	

● SDCN42HTR, SDKN42HTR

Shape	Designation	Coated				Applicable mill
		GH330				
	SDCN42HTR	●				EUD4600 (old item)
	SDKN42HTR	●				

● SDKN42EF..., SDEN42EFTR24

Shape	Designation	Coated	Cermet	Uncoated		Applicable mill
		T3130	NS740	TH10	UX30	
	SDKN42EFTR	●	●			TMD4100I (old item)
	SDKN42EFFR			●		
	SDEN42EFTR24		●		●	

● SDCN53HTR, SDKN53HTR

Shape	Designation	Coated				Applicable mill
		GH330				
	SDCN53HTR	●				TUD5600 (old item)
	SDKN53HTR	●				

●: Line up

Milling Insert (Old item)

Grade

Insert

Ext. Toolholder

Int. Toolholder

Threading

Grooving

Miniature tool

Milling cutter

Endmill

Drilling tool

Tooling System

User's Guide

Index



● SDMT1204AFPJ-MJ, SDMT1204AFTN-MJ, SDMT1204AFPJ-ML, SDMT1204AFPJ-MS, SDGT1204AFTN-MJ, SDGT1204AFPJ-AJ

Shape	Designation	Coated					Cermet		Uncoated		Applicable mill
		AH120	AH140	AH330	GH330	T3130	NS740		TH10		
 Rake angle Land width -MJ Rake angle -AJ Rake angle Land width -ML Rake angle Land width -MS	SDMT1204AFPJ-MJ	●	●	●	●	●					TAD12... EAD12... (old item)
	SDMT1204AFTN-MJ						●				
	SDMT1204AFPJ-ML		●		●						
	SDMT1204AFPJ-MS			●							
	SDGT1204AFTN-MJ		●		●		●				
	SDGT1204AFPJ-AJ								●		

● SDMT1204PDSR-MJ, SDMT1204PDTR-MJ, SDMT1204PDPR-ML, SDMT1204PDPR-MS, SDGT1204PDTR-MJ, SDGT1204PDPR-AJ

Shape	Designation	Coated					Cermet		Uncoated		Applicable mill
		AH120	AH140	AH330	GH330	T3130	NS740		TH10		
 Rake angle Land width -MJ Rake angle -AJ Rake angle Land width -ML Rake angle Land width -MS	SDMT1204PDSR-MJ	●	●	●	●	●					TPD12... EPD12... (old item)
	SDMT1204PDTR-MJ						●				
	SDMT1204PDPR-ML		●		●						
	SDMT1204PDPR-MS			●							
	SDGT1204PDTR-MJ		●		●		●				
	SDGT1204PDPR-AJ								●		

● SDMW090308TN, SDMW120408TN

Shape	Designation	Uncoated							Applicable mill
		UX30							
	SDMW090308TN	●							ELD3000
	SDMW120408TN	●							ELD4000 (old item)

●: Line up

Milling Insert (Old item)

● SECN422TN, SECN422FN, SEEN422TN, SEEN422FN, SECN422FN-DIA

Shape	Designation	ISO Designation (Metric)	Cermet		Uncoated		PCD		Applicable mill
			NS740	N308	UX30	TH10	DX140		
	SECN422TN	SECN120308TN	●	●	●				EGE4000 (old item)
	SECN422FN	SECN120308FN				●			
	SEEN422TN	SEEN120308TN	●	●	●				QHE4000 (old item)
	SEEN422FN	SEEN120308FN				●			
	SECN422FN-DIA	SECN120308FN-D					●		

DX140: Packing quantity = 1pc.

● SEEN1203AFTNCR-14, SEKN42AFTN, SEKN42AFFN, SEKN42AFTN16, SEKR42AFSR-MJ, SEKR1203AFPN-MS, SEKR1203AFTN-MJ, SEMR1203AFTN-MJ

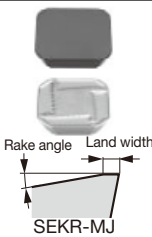
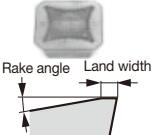
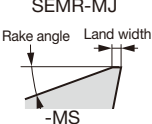
Shape	Designation	ISO Designation (Metric)	Coated					Cermet	Uncoated		Applicable mill
			AH120	AH130	AH140	GH330	T3130	NS740	TH10	UX30	
  	SEEN1203AFTNCR-14						●			TGE4400I (old item)	
	SEKN42AFTN	SEKN1203AFTN	●	●	●	●			●		
	SEKN42AFFN	SEKN1203AFFN							●	EGE4400 (old item)	
	SEKN42AFTN16	SEKN1203AFTN-16					●				
	SEKR42AFSR-MJ	SEKR1203AFSR-MJ				●	●				
	SEKR1203AFPN-MS					●					
	SEKR1203AFTN-MJ						●				
	SEMR1203AFTN-MJ						●				

● SECN42EFTRCR, SEEN42EFTRCR, SEKN42EFTR, SEKN42EFFR

Shape	Designation	ISO Designation (Metric)	Coated		Cermet	Uncoated		Applicable mill
			GH330	T3130	NS740	UX30	TH10	
	SECN42EFTRCR	SECN1203EFTR			●			EGE4100 (old item)
	SEEN42EFTRCR	SEEN1203EFTR			●			
	SEKN42EFTR	SEKN1203EFTR	●	●	●			
	SEKN42EFFR	SEKN1203EFFR					●	

● SEKR1504AFSR-MJ

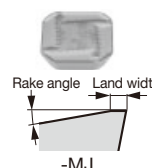
Shape	Designation	Coated					Applicable mill
		T3130					
	SEKR1504AFSR-MJ	●					(old item)

Milling Insert (Old item)

Grade

Insert

Ext. Toolholder

Int. Toolholder

Threading

Grooving

Miniature tool

Milling cutter

Endmill

Drilling tool

Tooling System

User's Guide

Index



● SF*N42ZFN, SFCN42ZFN-DIA

Shape	Designation	Uncoated		PCD		Applicable mill
		TH10		DX140		
	SFCN42ZFN	●				THF4400RIA (old item)
	SFEN42ZFN	●				
	SFCN42ZFN-DIA			●		

DX140: Packing quantity = 1pc.

● SF*N53ZFN, SFCN53ZFN-DIA

Shape	Designation	Uncoated		PCD		Applicable mill
		TH10		DX140		
	SFCN53ZFN	●				THF5400RIA (old item)
	SFEN53ZFN	●				
	SFCN53ZFN-DIA			●		

DX140: Packing quantity = 1pc.

● SNCN43Z..., SNKF43Z..., SNKN43ZTN

Shape	Designation	Coated		Cermet		Ceramic	Uncoated		Applicable mill
		T1115	T3130	NS740	N308	FX105	UX30	TH10	
	SNCN43ZFN							●	TGN4200R-A (old item)
	SNCN43ZTN			●	●		●		
	SNKF43ZFN							●	
	SNKF43ZTN	●					●		
	SNKN43ZTN	●	●	●		●	●		

● SNEN12**Z...

Shape	Designation	Uncoated		Applicable mill
		UX30	TH10	
	SNEN12T2ZFN		●	SVN4000 (old item)
	SNEN12T2ZTN	●		
	SNEN1233ZFN		●	
	SNEN1233ZTN	●		

● SNMN1204**TN

Shape	Designation	Coated			Cermic	Uncoated	Applicable mill
		AH120	T1115	T3130	FX105	UX30	
	SNMN120408TN				●		TGN4200R-A (Old item)
	SNMN120412TN	●	●	●	●	●	
	SNMN120416TN				●		
	SNMN120420TN				●		
	SNMN120424TN				●		





●: Line up

Milling Insert (Old item)

● SPGN120412TN

Shape	Designation	Coated		Ceramic		Applicable mill
		T1115		FX105		
	SPGN120412TN	●		●		QFP4000 (Old item)

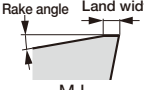

● SPMR1605PPTR-MJ, SPMR1605PPPR-ML, SPMR1605PPTR-MH

Shape	Designation	Coated			Uncoated		Applicable mill
		GH330	T1115	T3130	UX30		
	SPMR1605PPTR-MJ	●	●	●	●		TPP16... (Old item)
	SPMR1605PPPR-ML	●					
	SPMR1605PPTR-MH	●		●	●		
 -MJ							
 -ML							
 -MH							

● TDMN**N

Shape	Designation	Cermet		Uncoated		Applicable mill
		NS740		TH10	UX30	
	TDMN110304TN	●			●	ESD2000 (Old item)
	TDMN110304FN			●		
	TDMN110308TN	●			●	

● TNKF64ZTR

Shape	Designation	Uncoated				Applicable mill
		UX30				
	TNKF64ZTR	●				TPN64001 (Old item)
 Rake angle Land width						

●: Line up

Milling Insert (Old item)

Grade
Insert
Ext. Toolholder
Int. Toolholder
Threading
Grooving
Miniature tool
Milling cutter
Endmill
Drilling tool
Tooling System
User's Guide
Index

A
B
C
D
E
F
G
H
I
J
K
L
M

●TNMN43ZENS

Shape	Designation	Uncoated							Applicable mill
		UX30							
	TNMN43ZENS	●							TSN4000 ESN4000 (Old item)

●TPCA43ZTRW1, TPMA432TNW1

Shape	Designation	Cermet		Uncoated					Applicable mill
		NS740		UX30	TH10				
	TPCA43ZTRW1 TPMA432TNW1	●		●	●				PES1500... (Old item)

●TPMN**TN

Shape	Designation	Cermet							Applicable mill
		NS740							
	TPMN110304TN TPMN110308TN TPMN160308TN TPMN160312TN TPMN220408TN TPMN220412TN	●	●	●	●	●	●	●	(Old item)

●WCMT**-D4

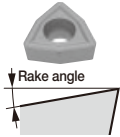
Shape	Designation	Coated							Applicable mill
		AH120	AH140						
	WCMT050308-D4 WCMT06T308-D4	●	●						EVX... (Old item) HVX... (Old item)

●WFCN**ZFR-DIA



Shape	Designation	PCD							Applicable mill
		DX140							
	WFCN42ZFR-DIA WFCN53ZFR-DIA	●	●						THF4400RIA (Old item) THF5400RIA (Old item)

DX140: Packing quantity = 1pc.

●: Line up

Milling Insert (Old item)

● XVGT**EC-MJ, XVGT**EP-MJ, XVGT**FC-AJ, XVGT**FP-AJ

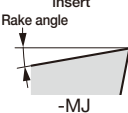
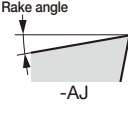
Shape	Designation	Coated							Applicable mill
		AH730	DS1200						
 Center edge insert  Peripheral edge insert  Rake angle -MJ  Rake angle -AJ	XVGT06H205EC-MJ	●							HYBRIDTACMILL EVH... (Old item)
	XVGT07X305EC-MJ	●							
	XVGT09X405EC-MJ	●							
	XVGT06H205EP-MJ	●							
	XVGT07X305EP-MJ	●							
	XVGT09X405EP-MJ	●							
	XVGT06H205FC-AJ		●						
	XVGT07X305FC-AJ		●						
	XVGT09X405FC-AJ		●						
	XVGT06H205FP-AJ		●						
	XVGT07X305FP-AJ		●						
	XVGT09X405FP-AJ		●						

● XHGR**ER-MJ, XHGR**FR-AJ

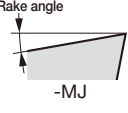
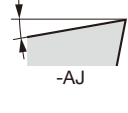
Shape	Designation	Coated							Applicable mill	
		AH730	DS1200							
  Rake angle -MJ  Rake angle -AJ	XHGR110202ER-MJ	●							HYBRIDTACMILL EPH11/13/18... (Old item)	
	XHGR110204ER-MJ	●								
	XHGR110205ER-MJ	●								
	XHGR110208ER-MJ	●								
	XHGR110210ER-MJ	●								
	XHGR110212ER-MJ	●								
	XHGR110215ER-MJ	●								
	XHGR110216ER-MJ	●								
	XHGR110220ER-MJ	●								
	XHGR130202ER-MJ	●								
	XHGR130204ER-MJ	●								
	XHGR130205ER-MJ	●								
	XHGR130208ER-MJ	●								
	XHGR130210ER-MJ	●								
	XHGR130212ER-MJ	●								
	XHGR130215ER-MJ	●								
	XHGR130216ER-MJ	●								
	XHGR130220ER-MJ	●								
	XHGR18T202ER-MJ	●								
	XHGR18T204ER-MJ	●								
	XHGR18T205ER-MJ	●								
	XHGR18T208ER-MJ	●								
	XHGR18T210ER-MJ	●								
	XHGR18T212ER-MJ	●								
	XHGR18T215ER-MJ	●								
	XHGR18T216ER-MJ	●								
	XHGR18T220ER-MJ	●								
	XHGR110200FR-AJ			●						
	XHGR110202FR-AJ			●						
	XHGR110204FR-AJ			●						
	XHGR110205FR-AJ			●						
	XHGR110208FR-AJ			●						
XHGR110210FR-AJ			●							

●: Line up

Milling Insert (Old item)

● XHGR**ER-MJ, XHGR**FR-AJ

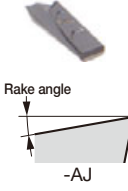
Shape	Designation	Coated		Applicable mill
		AH730	DS1200	
 <p>Rake angle -AJ</p>	XHGR130212FR-AJ	●		HYBRIDTACMILL EPH11/13/18... (Old item)
	XHGR130215FR-AJ	●		
	XHGR130216FR-AJ	●		
	XHGR130220FR-AJ	●		
	XHGR18T200FR-AJ	●		
	XHGR18T202FR-AJ	●		
	XHGR18T204FR-AJ	●		
	XHGR18T205FR-AJ	●		
	XHGR18T208FR-AJ	●		
	XHGR18T210FR-AJ	●		
	XHGR18T212FR-AJ	●		
	XHGR18T215FR-AJ	●		
	XHGR18T216FR-AJ	●		
	XHGR18T220FR-AJ	●		

● XXGT**EC-MJ, XXGT**FC-AJ, XXGT**EP-MJ, XXGT**FP-AJ

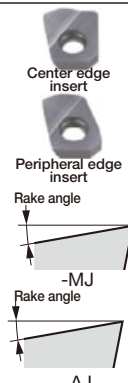
Shape	Designation	Coated		Applicable mill
		AH730	DS1200	
 <p>Center edge insert Peripheral edge insert Rake angle -MJ Rake angle -AJ</p>	XXGT06H205EC-MJ	●		HYBRIDTACMILL EXH... (Old item)
	XXGT07X305EC-MJ	●		
	XXGT09X408EC-MJ	●		
	XXGT06H205FC-AJ		●	
	XXGT07X305FC-AJ		●	
	XXGT09X408FC-AJ		●	
	XXGT06H205EP-MJ	●		
	XXGT07X305EP-MJ	●		
	XXGT09X408EP-MJ	●		
	XXGT06H205FP-AJ		●	
	XXGT07X305FP-AJ		●	
	XXGT09X408FP-AJ		●	

● YDEN1505ADFR-D, YDEN1505ADFR-WD

Shape	Designation	PCD		Applicable mill
		DX140		
 <p>Regular edge Wiper edge</p>	YDEN1505ADFR-D	●		DAD15... (Old item)
	YDEN1505ADFR-WD	●		



DX140: Packing quantity = 1 pc.

●: Line up





Milling Insert (Old item)

● YDEN1505PDRF-D, YDEN1505PDRF-WD

Shape	Designation	PCD					Applicable mill
		DX140					
 Regular edge	YDEN1505PDRF-D	●					DPD15... EDPD15... (Old item)
	YDEN1505PDRF-WD	●					
 Wiper edge							

DX140: Packing quantity = 1pc.

● YDEN2405PDRF-D, YDEN2405PDRF-WD, YDEN2405PDRF-BD

Shape	Designation	PCD					Applicable mill
		DX140					
 Regular edge	YDEN2405PDRF-D	●					DPD24... (Old item)
	YDEN2405PDRF-WD	●					
	YDEN2405PDRF-BD	●					
 Wiper edge							
 Wiper for burr removal							

DX140: Packing quantity = 1pc.

● ZDCA**TN

Shape	Designation	Uncoated					Applicable mill
		UX30					
	ZDCA0804TN	●					TBF1000 (Old item)
	ZDCA1105TN	●					

●: Line up

Milling Insert (Old item) CBN

Grade

Insert

Ext. Toolholder

Int. Toolholder

Threading

Grooving

Miniature tool

Milling cutter

Endmill

Drilling tool

Tooling System

User's Guide



Index





● 2QP-SNGN..

Shape	Designation	CBN						Applicable mill
		BX910						
	2QP-SNGN090308	●						
	2QP-SNGN090312	●						





● 2QP-SPGW..., 2QP-SPGN...

Shape	Designation	CBN						Applicable mill
		BX910						
	2QP-SPGW09T308	●						
	2QP-SPGW09T312	●						
	2QP-SPGW120408	●						
	2QP-SPGW120412	●						
	2QP-SPGW120416	●						
	2QP-SPGN090308	●						
	2QP-SPGN090312	●						

● 3QP-TPGW..., 3QP-TPGN...

Shape	Designation	CBN						Applicable mill
		BX910						
	3QP-TPGW110308	●						
	3QP-TPGN110308	●						
	3QP-TPGN110312	●						
								

● S-CNGN..., S-RNGN..., S-SNGN..., S-TNGN...

Shape	Designation	CBN						Applicable mill
		BXC90						
	S-CNGN090308	●						
	S-CNGN090312	●						
	S-CNGN120408	●						
	S-CNGN120412	●						
	S-RNGN090300	●						
	S-RNGN120400	●						
	S-SNGN090308	●						
	S-SNGN090312	●						
	S-SNGN120308	●						
	S-SNGN120312	●						
	S-SNGN120408	●						
	S-SNGN120412	●						
	S-TNGN110308	●						
	S-TNGN110312	●						
	S-TNGN160408	●						
	S-TNGN160412	●						

●: Line up

Alphanumeric Index

Milling

Designation	Product name	Page	Designation	Product name	Page
1QP-SECW12X4ZETR-B	TFE insert	H098	EBP...	EBP endmill	H206
1QP-SECW12X4ZETR-W	TFE insert	H098	EBRM□□T...	BallRoughNose endmill, shank type	H201
2QP-SECW12X412ZETR	TFE insert	H098	ECC31005R-...	Chamfering cutter	H214
A			ECP44□□R	Chamfering cutter	H213
AOGT□□□□□PDFR-AJ	TungRec insert	H145	EDPD09063R	EDPD09 endmill, shank type	H100
AOGT070204PDFR-AJ	TungRec insert	H145	EEN09R□□□M...	DoPent endmill, shank type	H070
AOMT□□□□□PDFR-MJ	TungRec insert	H145	EFE12050R	TFE endmill, shank type	H096
AOMT070□□□PDFR-MJ	TungRec insert	H145	EFP40□□R	EFP4000R endmill, shank type	H236
AOMT070208PDFR-HJ	TungRec insert	H145	EGD44□□R	EGD4400 endmill, shank type	H110
APMR190616PR-MJ	TZP19 insert	H228	ELD05R□□□M...	TungQuad roughing endmill, shank type	H148
APMT120416PR-MJ	TZP12 insert	H226	ELS11R□□□M...	TungRec roughing endmill, shank type	H143
ASG□□N...	TungMini-Slit side cutter	H181	EMD4403RI-S32	EMD4400RI endmill, shank type	H106
ASGT11T□□□PDFR-AJ	TungRec insert	H145	EME44□□R...	EME4400 endmill, shank type	H103
ASGW11T30□PDFR-D	TungRec insert	H145	EMS09080R	EMS09 endmill, shank type	H232
ASMT11T□□□PDFR-MJ	TungRec insert	H145	EPA□□R□□□M...	Tung-Tri endmill, shank type	H130
ASMT11T304PDFR-MS	TungRec insert	H145	EPAV□□M□□□C...	TungForce-Rec endmill, shank type	H122
ASN□□R□□□M...	TecTangential-Slot axial drive slot mill	H189	EPD05R□□□M...	TungQuad chamfering cutter	H148
ASV□□N...	TungThinSlit axial drive slot mill	H185	EPM11R□□□M...	TecMill square shoulder endmill, shank type	H163
ASW□□N...	TungUniversalSlot axial drive slot mill	H187	EPO□□R□□□M...	TungRec endmill, shank type	H140, H141
AVGT□□□□□PBER-MJ	TungForce-Rec insert	H126	EPQ□□R□□□M...	DoRec endmill, shank type	H154
AVGT□□□□□PBFR-AJ	TungForce-Rec insert	H126	EPTC16M□□□C...	TungTri-Shred endmill, shank type	H170
AVGT□□□□□PDFR-AM	TungForce-Rec insert	H126	EPTN□□M0□□□C...	DoForce-Tri endmill, shank type	H150
AVMT□□□□□PDER-MM	TungForce-Rec insert	H126	EPV16R□□□M...	Tung-AluMill endmill, shank type	H160
AVMT□□□□□PPER-MM	TungForce-Rec insert	H126	EPW13R□□□M...	TungMill endmill, shank type	H167
B			EPYD06M050C32.0R...	TungSpeed-Mill endmill, shank type	H092
BBB...	T-CBN ball nose endmill for dies and mold	I059	EPYP12M□□□C...	TungSpeed-Mill cutter body	H158
BT50-FMA31.75-...	TPX, TZP12/19, TZF arbor	H055, H227, H229, H231	ERC□□R0□□M...	RoundSplit endmill, shank type	H074
BT50-FMA38.1-375-98	Arbor for TZP19	H229	ERP□□R□□□M...	FixRMill endmill, shank type	H080
BT50-FMC22-...	TPX, TZP12, TZF arbor	H055, H227, H231	ERRQ12M040C32.0R04	FixRMill -New design- endmill, shank type	H078
C			ESE30□□R	ESE3000R endmill, shank type	H173
C□TLA15M□□□R□□L...	Tung-Tri roughing cutter with TungCap connection	H134	ESE40□□R...	ESE4000R endmill, shank type	H175
D			ETLN25M□□□W25.0F□□□R...	Indexable threading cutter	I126
D□□-D□□-□□R	Indexable threading cutter	I128	ETTL25M□□□W25.0F□□□R...	Indexable threading cutter	I124
DCMW□□□□04TN	EBP insert	H207	ETTL25M□□□W25.0F□□□R□□-PT	Indexable threading cutter	I125
DEB...	T-DIA endmill for high speed aluminium machining	I058	EVLX□□□M□□□□C□□.0R...	DoMultiRec endmill	H221
DPCW11T3ZFR	TZF11 insert	H230	EVX...	Endmill with central cutting edge, shank type	H224
DPD09...	DPD09 cutter body	H100	EWD□□□□□R	EWD05/07/10 endmill, shank type	H203
E			EXLN□□□M□□□□C...	DoTwistBall endmill, shank type	H046
EASD05M□□□C...	TungQuad chamfering cutter	H210	EXLS02M□□□C...	TungForceFeed endmill, shank type	H038
EAW13R□□□M...	TungMill face endmill, shank type	H068	EXN02R□□□□M...	AddDoFeed endmill, shank type	H020
EBB□□□MS	EBB endmill	H208	EXN03R□□□□M...	DoFeed endmill, shank type	H024
EBD...	EBD endmill	H209	EXN06R□□□□M...	DoFeed endmill, shank type	H025
EBFM□□□□□C...	BallFinishNose endmill, shank type	H193	EXP□□□□□R...	MillFeed endmill, shank type	H051
EBFM□□□□□S...	BallFinishNose endmill, shank type	H193	EXSW09M□□□□C...	MillQuadFeed cutter head	H057
H			EXWX03M□□□□C...	DoFeedTri endmill, shank type	H042
HBFM□□□M...	BallFinishNose cutter head	H194	H		
HBRM□□□M...	BallRoughNose cutter head	H201	HBFM□□□M...	BallFinishNose cutter head	H194
HFWX04M□□□□M...	DoMini-Mill cutter head	H200	HBRM□□□M...	BallRoughNose cutter head	H201
HFZN10M□□□□M□□R...	AddForceBarrel cutter head	H198	HFWX04M□□□□M...	DoMini-Mill cutter head	H200
			HFZN10M□□□□M□□R...	AddForceBarrel cutter head	H198

Designation	Product name	Page
HPA□□R□□□MM...	Tung-Tri cutter head	H131
HPAV□□M□□□M...	TungForce-Rec cutter head	H124
HPAV06M□□□S...	TungForce-Rec cutter head	H123
HPO□□R□□□MM...	TungRec cutter head	H141
HRP□□R□□□MM...	FixRMill cutter head	H080
HVLX□□M□□□M□□R02	DoMultiRec cutter head	H221
HWD07R□□□MM...	HWD07 Cutter head	H203
HXLN□□M□□□M...	DoTwistBall cutter head	H046
HXLS02M□□□M...	TungForceFeed cutter head	H038
HXN02R□□□M...	AddDoFeed cutter head	H020
HXN03R□□□MM...	DoFeed cutter head	H025
HXSW09M□□□M...	MillQuadFeed cutter head	H057
HXWX03M□□□C...	DoFeedTri cutter head	H042

L		
LMEU□□□□□□ZNER-MJ	TecTangential-Slot insert	H191
LMMU□□□□□□PNER-MJ	TecMill insert	H165
LN25D...	Insert for threading cutter	I126
LNQC0906□-...	NMS09 / EMS09 insert	H233
LNGU0303ZER-MH	DoFeed 03insert	H029
LNGU06X5ZER-MH	DoFeed 06insert	H029
LNGU06X5ZER-W	DoFeed 06insert	H029
LNMU0202ZER-MM	AddDoFeed 02insert	H021
LNMU0303□ER-MJ	DoFeed 03insert	H029
LNMU0303□ER-ML	DoFeed 03insert	H029
LNMU0303ZER-MS	DoFeed 03insert	H029
LNMU06X5ZER-MJ	DoFeed 06insert	H029
LNMU06X5ZER-ML	DoFeed 06insert	H029
LNMX□□□□□R□-MJ	DoTwistBall insert	H047
LNMX□□□□□R□-ML	DoTwistBall insert	H047
LNMX□□□□□ZER-HJ	DoTwistBall insert	H047
LNMX0405ZER-HL	DoTwistBall insert	H047
LPTC16□□□□B...	TungTri-Shred roughing cutter	H170
LQMU□□□□□□P□ER-MJ	DoRec insert	H155
LSMT0202R2-MM	TungForceFeed insert	H039
LSMT0202ZER-HM	TungForceFeed insert	H039
LXMU□□□□□□PER-MM	DoMultiRec insert	H222

M		
MS□□R/L	MS cutter body	H234
MTEC□□□□□□□□□□ISO	60° solid carbide threading endmill	I108
MTEC□□□□□□□□BSPT	BSPT solid carbide threading endmill	I117
MTEC□□□□□□□□UN	60° solid carbide threading endmill	I113
MTEC□□□□□□□□NPT	BSPT solid carbide threading endmill	I118
MTEC□□□□□□□□W	BSPT solid carbide threading endmill	I116
MTECB□□□□□□□□□□ISO	ISO solid carbide threading endmill, with coolant hole	I109
MTECB□□□□□□□□□□NPT	NPT solid carbide threading endmill, with coolant hole	I118
MTECB□□□□□□□□□□UN	ISO solid carbide threading endmill, with coolant hole	I113
MTECB□□□□□□□□□□W	NPT solid carbide threading endmill, with coolant hole	I116
MTECD□□□□□□□□□□ISO	ISO solid carbide thread mill for boring, threading, chamfering	I112
MTECE□□□□□□□□□□ISO	ISO solid carbide external threading endmill	I112
MTECE□□□□□□□□□□UN	ISO solid carbide external threading endmill	I115
MTECI□□□□□□□□□□ISO	60° solid carbide threading endmill	I108
MTECI□□□□□□□□A60	60° solid carbide threading endmill	I107
MTECI□□□□□□□□A60	60° solid carbide threading endmill	I107
MTECI□□□□□□□□E□□A60	60° solid carbide threading endmill	I107
MTECQ□□□□□□□□□□ISO	ISO solid carbide deep threading endmill, with coolant hole, with coolant hole	I110
MTECS□□□□□□□□□□ISO	ISO small diameter solid carbide threading endmill, short edge type	I111
MTECS□□□□□□□□□□ISOL	ISO small diameter solid carbide threading endmill, short edge type	I111
MTECS□□□□□□□□□□MJ	MJ small diameter solid carbide threading endmill, short edge type, with coolant hole	I119
MTECS□□□□□□□□□□MJ	MJ small diameter solid carbide threading endmill, short edge type, with coolant hole	I119
MTECS□□□□□□□□□□UN-L	ISO small diameter solid carbide threading endmill, short edge type	I114
MTECS□□□□□□□□□□UNJ	MJ small diameter solid carbide threading endmill, short edge type, with coolant hole	I119
MTECS□□□□□□□□□□UN	ISO small diameter solid carbide threading endmill, short edge type	I114
MTECS□□□□□□□□□□UNJ	MJ small diameter solid carbide threading endmill, short edge type, with coolant hole	I119
MTECS□□□□□□□□□□W	Whitworth solid carbide thread mill for threading, short edge type	I117
MTECS06047C1920UN-L	ISO small diameter solid carbide threading endmill, short edge type	I114
MTECSH□□□□□□□□□□ISO	ISO solid carbide thread mill for machining, short edge type, left hand	I112
MTECSH□□□□□□□□□□UN	ISO solid carbide thread mill for machining, short edge type, left hand	I115
MTECZ□□□□□□□□□□ISO	ISO solid carbide threading endmill, with coolant hole	I110
MTECZ□□□□□□□□□□UN	ISO solid carbide threading endmill, with coolant hole	I114
MTECZ□□□□□□□□□□W	NPT solid carbide threading endmill, with coolant hole	I116

Designation	Product name	Page
MTECZ08076C1027NPTF	NPT solid carbide threading endmill, with coolant hole	I118
MTECZ1010D1618NPTF	NPT solid carbide threading endmill, with coolant hole	I118
N		
NMS09□□□R	NMS09 cutter body	H232
O		
ON□U0507ANEN-MJ	DoTriple-Mill insert	H086
ON□U0705AN□N-ML	DoOcto insert	H090
ON□U0705ANPN-MJ	DoOcto insert	H090
ONGU0507ANEN-W	DoTriple-Mill insert	H086
ONHU0705ANPR-W	DoOcto insert	H090
OWHT05T3C07AFER-MM	TungEight-Mill insert	H083
OWHT05T3C07AFER-MW	TungEight-Mill insert	H083
OWMT05T3AFER-MM	TungEight-Mill insert	H083
OWMT0807AAER-ML	DoOcto insert	H090
OWMT0807ZNER-HJ	DoOcto insert	H090

P		
PN□U0905GNE□-MJ	DoPent insert	H072
PNCU0905GNEN-ML	DoPent insert	H072
PNCU0905GNER-W	DoPent insert	H072
PNCU0905GNFR-AJ	DoPent insert	H072

Q		
QA□□K/M	Adapter for TAC mill/QC system	H117
QACB-□□MR/L	A-type set bolt for TAC mill/QC system	H118

R		
R1.□□-...	TungMini-Slit drive flange set for side cutter	H183
RCMT□□□□EN-MM	RoundSplit insert	H076
RCMT□□□□EN-NMJ	RoundSplit insert	H076
RCMT□□□□FN-NAJ	RoundSplit insert	H076
RDMW□□□□M0	Insert for EWD/HWD	H204
RNGN120700...	CeramicSpeed-Mill insert	H102
RNMU1307ZNER-MJ	DoTriple-Mill insert	H086
RPMT□□□□EN-MJ	FixRMill insert	H081
RPMT□□□□EN-ML	FixRMill insert	H081
RQMT1204ENC□-MM	FixRMill -New design- insert	H079

S		
SCMT□□□□08-23	EBD insert	H209
SD□□42Z...	TMD4400R/LI, EMD4400Rl insert	H107, H111
SD□□42Z□N...	TGD4400-A, EGD4400 insert	H107, H111
SD□N42ZTNCR	TGD4400-A, EGD4400 insert	H107, H111
SD□N53Z□N...	TMD5401Rl insert	H109
SD□R1203AETN-MJ	TMD4400R/LI, EMD4400RI, TGD4400-A,EGD4400 insert	H107, H111
SD□R42ZSR-MJ	TMD4400R/LI, EMD4400RI, TGD4400-A,EGD4400 insert	H107, H111
SDCN42ZFN-DIA	TMD4400R/LI, EMD4400RI insert	H107, H111
SDHT050204FN-AJ	TungQuad insert	H149, H210
SDKR42ZPN-MS	TMD4400R/LI, EMD4400RI, TGD4400-A,EGD4400 insert	H107, H111
SDKR53ZSR-MJ	TMD5401Rl insert	H109
SDMT050204PN-MJ	TungQuad insert	H149, H210
SE□N1203AG□N	TME4400R/LI, TME4400RB, EME4400 insert	H104
SE□N1203AG□N-T	TME4400R/LI, TME4400RB, EME4400 insert	H104
SE□N1203AGTNCR	TME4400R/LI, TME4400RB, EME4400 insert	H104
SE□N1504AG□N	TME5400RI insert	H105
SE□N42ZFR	THE4000RIA insert	H172
SECN42ZFR-DIA	THE4000RIA insert	H172
SEEN1203AGTNCR-14	TME4400R/LI, TME4400RB, EME4400 insert	H104
SEGT12X4ZEFR-AJ	TFE insert	H098
SEGW12X4ZE□R	TFE insert	H098
SEGW12X4ZEFR-BD	TFE insert	H098
SEGW12X4ZEFR-D	TFE insert	H098
SEGW12X4ZEFR-WD	TFE insert	H098
SEKN1504AGTN-T	TME5400RI insert	H105
SEKR1203AGPN-MS	TME4400R/LI, TME4400RB, EME4400 insert	H104
SEKR1203AGSR-MJ	TME4400R/LI, TME4400RB, EME4400 insert	H104
SEKR1504AGSR-MJ	TME5400RI insert	H105
SFP40□□R	SFP4000R cutter body	H235
SM□□-L...	TungFlex Steel modular shank	H036
SM□□-L□□□□□-H	TungFlex carbide modular shank	H037
SM□□-L□□□□□-H-N	TungFlex carbide modular shank	H037
SNAA56FTR	MS insert	H234

Alphanumeric Index

Designation	Product name	Page
SN□U1307ANEN-MJ	DoTriple-Mill insert	H086
SN□U1706ANPR-MJ	DoOcto insert	H090
SN□U1706ANTR-ML	DoOcto insert	H090
SNGU1307ANEN-MH	DoTriple-Mill insert	H086
SNGU1307ANEN-W	DoTriple-Mill insert	H086
SNHU1706ANFN-W	DoOcto insert	H090
SNMU1206□EN-MM	DoQuad-Mill insert	H159
SNMU120608HNEN-MM	DoQuad-Mill insert	H159
SP□N423□N	TGP4200R-A insert	H112, H113
SP□N42S...	TGP4100RIA/BA insert	H112
SP□N42Z...	TGP4200R-A insert	H113
SP□N53S...	TGP5100RIA insert	H114
SPGN120312TN	TGP4100RIA/BA insert	H112
SPHA431FNW	TFP4000IA insert	H178
SPHA435FNW	SFP4000R, EFP4000R insert	H237
SPKN53STR20	TGP5100RIA insert	H114
SPKR42SSR-MJ	TGP4100RIA/BA insert	H112
SPKR53SSR-MJ	TGP5100RIA insert	H114
SPMA422□N	ECP insert	H213
SPMM□□ERD	TCB insert	H219
SPMP□□□-CG	TCB insert	H219
SPMP□□□ER-CG	TCB insert	H219
SPMP□□□ERD	TCB insert	H219
SPMP831DS	TCB insert	H219
SQMU1206ZSR-MJ	DoFeedQuad insert	H063
SSG□□R...	TungMini-Slit side cutter	H181
SSM□□N	TungMini-Slit insert	H182
SSS□□N	TungMini-Slit insert	H182
SW□□-...	TungMini-Slit drive shank for side cutter	H183
SW□T1304PDR-MJ	TungMill insert	H169
SW□T13T3AFPR-MJ	TungMill insert	H069
SW1.□□-...	TungMini-Slit drive shank for side cutter	H183
SWG1304PDR-AJ	TungMill insert	H169
SWG13T3AFPR-AJ	TungMill insert	H069
SWMT0904□ER-MM	MillQuadFeed insert	H059
SWMT1304PDR-ML	TungMill insert	H169
SWMT1304PDR-MS	TungMill insert	H169
SWMT13T3AFER-ML	TungMill insert	H069
SWMT13T3AFPR-HJ	TungMill insert	H069
SWMT13T3AFPR-MS	TungMill insert	H069
SWMT1506□ER-MM	MillQuadFeed insert	H059
SWMT1506ZER-MJ	MillQuadFeed insert	H059
SWMT1506ZER-MT	MillQuadFeed insert	H059
SWMW13T3AFTR	TungMill insert	H069
T		
T□-R...	Insert for threading cutter	H128
TAOW05M□□□B...	TungEight-Mill cutter body	H083
TAN07R□□□M...	DoOcto cutter body	H088, H089
TASN13M□□□B...	DoTriple-Mill cutter body	H085
TASN13J□□□B...	DoTriple-Mill cutter body	H085
TAW13R□□□M...	TungMill cutter body	H068
TBN□□□□S	TBN1000 endmill	H205
TCB-...	Boring cutter	H216
TCB□□□-□□□F32	Boring cutter, cartridge type	H217
TCB□□□F...	Boring cutter	H216
TCFF□□□A3-...	FeedMeister 3 flute high feed endmill	I055
TCGT1606□□PDER-MJ	TungTri-Shred insert	H171
TCGT1606□□PDER-NMJ	TungTri-Shred insert	H171
TE□N32Z□R	TSE3000R, ESE3000R insert	H174
TE□N43Z□R	TSE4000RIA, ESE4000R insert	H176
TEAP□□□H3-...	ShredMeister 3 flute solid endmill	I031
TEB□□□A2-□□□□□□□□...	SolidMeister 2flute solid endmill	I051
TEB□□□A2-□□□□□□□□...	SolidMeister 2flute solid endmill	I050
TEB□□□A2-□□□□□□□□...	SolidMeister 2flute solid endmill	I050
TEB□□□A2-□□□□□□□□...	SolidMeister 2flute solid endmill	I049
TEB□□□A2-□□□□□□□□...	SolidMeister 2flute solid endmill	I051
TEB□□□A2-□□□□□□-E...	EcoMeister 2flute solid endmill	I052
TEB□□□A2-□□□□□□M...	SolidMeister 2flute solid endmill	I050
TEB□□□A2-□□□□□□-E...	EcoMeister 2flute solid endmill	I052
TEB□□□A3-□□□□□□-...	SolidMeister 3flute solid endmill	I051
TEB□□□A4-□□□□□□-...	SolidMeister 4flute solid endmill	I052
TEB□□□E4L-...	VariableMeister 4flute solid endmill	I048
TEBRF□□□T3-...	ShredMeister 3 - 4flute solid endmill	I048
TEBRF□□□T4-...	ShredMeister 3 - 4flute solid endmill	I048
TEC□□□A2-□□□□□□C4M...	SolidMeister 2flute solid endmill	I038
TEC□□□A2-□□□□□□C6M...	SolidMeister 2flute solid endmill	I038, I039

Designation	Product name	Page
TEC□□□A2-□□□□□□C4M...	SolidMeister 2flute solid endmill	I038
TEC□□□A2-□□□□□□-E...	EcoMeister 2flute solid endmill	I043
TEC□□□A2-□□□□□□-E...	EcoMeister 3flute solid endmill	I043
TEC□□□A3-□□□□□□-E...	EcoMeister 3flute solid endmill	I044
TEC□□□A4-□□□□□□-...	EcoMeister 4flute solid endmill	I039
TEC□□□A4-□□□□□□-E...	EcoMeister 4flute solid endmill	I045, I046
TEC□□□A4-□□□□□□-E...	EcoMeister 4flute solid endmill	I045
TEC□□□B3-□□□□□□-...	SolidMeister 3flute solid endmill	I036
TEC□□□B3-□□□□□□-...	EcoMeister 3flute solid endmill	I045
TEC□□□B4-□□□□□□-...	SolidMeister 4flute solid endmill	I037
TEC□□□B4-□□□□□□-...	SolidMeister 4flute solid endmill	I037
TEC□□□B4-□□□□□□R□□-...	SolidMeister 4flute solid endmill	I037
TEC□□□B4L-...	SolidMeister 4flute - 6flute solid endmill	I034
TEC□□□B4X-...	SolidMeister 4flute - 6flute solid endmill	I034
TEC□□□B6-...	SolidMeister 6flute solid endmill	I040
TEC□□□B6L-...	SolidMeister 4flute - 6flute solid endmill	I034
TEC□□□B6X-...	SolidMeister 4flute - 6flute solid endmill	I034
TEC□□□D6-...	SolidMeister 6flute solid endmill	I041
TEC□□□E3-□□□□□□-E...	EcoMeister 3flute solid endmill	I044
TEC□□□E4L-...	VariableMeister 4flute solid endmill	I017
TEC□□□E5L-□□□□□□CF...	VariableMeister 5flute solid endmill	I017
TEC□□□H□-□□□□□□CF-H...	VariableMeister 6 - 20flute solid endmill	I019
TEC□□□H□□-□□□□□□CF-H...	VariableMeister 6 - 20flute solid endmill	I019
TEC□□□H□□-□□□□□□CFH...	VariableMeister 6 - 20flute solid endmill	I019
TEC□□□H4M-□□□□□□CF-E...	VariableMeister 4flute solid endmill	I016
TEC□□□H4M-□□□□□□CF-R...	VariableMeister 4flute solid endmill	I020
TEC□□□H4M-□□□□□□CFR...	VariableMeister 4flute solid endmill	I020
TEC□□□H4S-...	VariableMeister 4flute solid endmill	I016
TEC□□□H4X-□□□□□□CF-R...	VariableMeister 4flute solid endmill	I021
TEC□□□H7-□□□□□□CF-...	VariableMeister 7flute solid endmill	I018
TECA□□□B2-...	SolidMeister 2flute solid endmill	I041
TECA□□□B3-...	SolidMeister 3flute solid endmill	I042
TECA□□□F2-...	SolidMeister 2flute solid endmill	I042
TECA□□□H3-□□□□□□CF-R...	VariableMeister 3flute solid endmill	I023
TECA□□□H3-□□□□□□CF-R...	VariableMeister 3flute solid endmill	I022
TECA□□□H3-□□□□□□CF-R□□C	VariableMeister 3flute solid endmill	I024
TECA□□□H4-...	VariableMeister 4flute solid endmill	I024
TECC□□□A2-□□□□□□-...	SolidMeister 2flute solid endmill	I035
TECC□□□A4-□□□□□□-...	SolidMeister 4flute solid endmill	I036
TECC□□□E3-□□□□□□-...	SolidMeister 3flute solid endmill	I036
TECC020B2-07C03-38	SolidMeister 2flute solid endmill	I035
TECC020B4-07C03-38	SolidMeister 4flute solid endmill	I036
TECCS□□□E3-□□□□□□-...	SolidMeister 3flute solid endmill	I035
TECH□□□B6-...	SolidMeister 6flute solid endmill	I040
TECK□□□H4M-□□□□□□CF-R...	VariableMeister 4flute solid endmill	I019
TECK□□□H7-□□□□□□CF-R□□T...	VariableMeister 7 - 9flute solid endmill	I020
TECK□□□H9-□□□□□□CF-R□□T...	VariableMeister 7 - 9flute solid endmill	I020
TECN32ZFR-DIA	TSE3000R, ESE3000R insert	H174
TECN43ZFR-DIA	TSE4000RIA, ESE4000R insert	H176
TECP□□□E3L-...	ShredMeister solid endmill	I030
TECP□□□E4L-...	ShredMeister solid endmill	I030
TECR□□□B□L-...	ShredMeister 4 - 7flute solid endmill	I029
TECR□□□B□M-...	ShredMeister 4 - 7flute solid endmill	I028
TECR□□□B□MF-...	ShredMeister 4 - 6flute solid endmill	I028
TECR□□□B□S-□□□□□□-...	ShredMeister 4 - 7flute solid endmill	I027
TECR□□□B□X-...	ShredMeister 4 - 5flute solid endmill	I029
TECR□□□B3-...	ShredMeister 3 flute solid endmill	I032
TECR□□□T4M-...	ShredMeister 4flute solid endmill	I030
TECS□□□E3-□□□□□□-...	SolidMeister 3flute solid endmill	I035
TEFF□□□N4-...	FeedMeister 4flute solid endmill	I055
TEFS□□□B44-□□□□□□-...	FinishMeister 4flute solid endmill	I027
TEFS□□□B44-□□□□□□-...	FinishMeister 4flute solid endmill	I027
TEFS□□□E4-□□□□□□CF...	FinishMeister 4flute solid endmill	I026
TEKR1603PEPR-MS	TSE3000R, ESE3000R insert	H174
TEKR2204PEPR-MS	TSE4000RIA, ESE4000R insert	H176
TEN09R/L□□□M...	DoPent cutter body	H071
TERC□□□E3-...	ShredMeister 3 flute solid endmill	I031
TERF□□□A4-...	ShredMeister 3 - 4flute solid endmill	I029
TERF□□□E3-...	ShredMeister 3 - 4flute solid endmill	I029
TETR□□□A2-...	SolidMeister 2flute solid endmill	I056
TFE12□□□R	TFE cutter body	H096
TFE12R□□□M...	TFE cutter body	H096
TFMRN□□□-□□R-12FL	CeramicSpeed-Mill cutter body	H102
TFP40□□□RIA	TFP4000IA cutter body	H177
TGD44□□□R-A	TGD4400-A cutter body	H110
TGM16R□□□M□□□□□□SA	TecMill 60° face mill	H164
TGM16R□□□M□□□□□□SA	TecMill 60° face mill	H164

Designation	Product name	Page
TGP41□□RBA	TGP4100RIA/RBA/RBAE cutter body	H112
TGP41□□RBAE	TGP4100RIA/RBA/RBAE cutter body	H112
TGP41□□RIA	TGP4100RIA/RBA/RBAE cutter body	H112
TGP42□□R-A	TGP4200R-A cutter body	H113
TGP51□□RIA	TGP5100RIA cutter body	H114
THE400□RIA	THE4000RIA cutter body	H172
THSN12J□□□B...	DoQuad-Mill cutter body	H158
THSN12M□□□B...	DoQuad-Mill cutter body	H158
TL25D...	Insert for threading cutter	I124
TL25SEIR...	Insert for threading cutter	I125
TLA10R□□□L054M...	Tung-Tri roughing cutter	H133
TLA15R□□□L□□□-□□S	Tung-Tri roughing cutter, subunit	H133
TLA15R□□□L□□□BT50-0□M	Tung-Tri roughing cutter with BT shank	H134
TLA15R□□□L□□□M...	Tung-Tri roughing cutter, main unit	H133
TLM11R□□□M...	TecMill roughing cutter	H165
TLS11R050M22.0E04	TungRec roughing cutter	H143
TMD44□□R...	TMD4400R/LI cutter body	H106
TMD54□□RI...	TMD5400RI cutter body	H108
TME44□□R...	TME4400R/LI cutter body	H103
TME54□□RI	TME5400RI cutter body	H105
TN□U□□□□□□PER-MJ	DoForce-Tri insert	H152
TNMU120708PER-NMJ	DoForce-Tri insert	H152
TNMU1207R□□PER-MJ	DoForce-Tri insert	H152
TO□T□□□□□□PDER-MJ	Tung-Tri insert	H136
TOGT□□□□□□PDR-AJ	Tung-Tri insert	H136
TOMT□□□□□□PXER-MM	Tung-Tri insert	H136
TOMT150604PDER-NMJ	Tung-Tri insert	H136
TP□N43Z...	TFP4000IA insert	H178
TPA□□□□□□M...	Tung-Tri cutter body	H132
TPAV□□□□□□B...	TungForce-Rec cutter body	H125
TPD05R□□□□M...	TungQuad cutter body	H148
TPKR43ZSR-MJ	TFP4000IA insert	H178
TPM□□□□□□□M...	TecMill square cutter body	H163
TPM16R□□□□□□□□□□SA	TecMill square cutter body with shims	H164
TPM16R□□□□□□□□□□SA	TecMill square cutter body with shims	H164
TPMR2204PDSR-MJ	TFP4000IA insert	H178
TPO□□□□□□□M...	TungRec cutter body	H142
TPQ□□□□□□□M...	DoRec cutter body	H154
TPTC16M□□□□B...	TungTri-Shred cutter body	H170
TPTN□□□□□□□B...	DoForce-Tri cutter body	H151
TPTN□□□□□□□B...	DoForce-Tri cutter body	H151
TPV16R□□□□M...	Tung-AluMill cutter body	H160
TPW13R□□□□M...	TungMill cutter body	H168
TPYD06J□□□□B...	TungSpeed-Mill cutter body	H092
TPYD06M□□□□B...	TungSpeed-Mill cutter body	H092
TPYP12J□□□□B...	TungSpeed-Mill cutter body	H094
TPYP12M□□□□B...	TungSpeed-Mill cutter body	H094
TRC□□□□□□□M...	RoundSplit cutter body	H075
TRP□□□□□□□M...	FixRMill cutter body	H081
TRRQ12M□□□□B...	FixRMill -New design- cutter body	H078
TSE30□□□R	TSE3000R cutter body	H173
TSE30□□□R-E	TSE3000R cutter body	H173
TSE30□□□RIA	TSE3000R cutter body	H173
TSE40□□□RIA	TSE4000RIA cutter body	H175
TSN□□□□□□□M...	TecTangential-Slot radial drive slot mill	H190
TSP40□□□RIA	TSP4000IA cutter body	H177
TSW□□□□...	TungUniversalSlot radial drive slot mill	H188
TVKX□□□□□□□TN-MJ	TungThinSlit insert	H186
TXLN□□□□□□□B...	DoTwistBall cutter body	H047
TXN03R□□□□M...	DoFeed cutter body	H026
TXN06R□□□□M...	DoFeed cutter body	H027
TXP□□□□□□□R...	MillFeed cutter body	H052
TXQ12R□□□□M...	DoFeedQuad cutter body	H063
TXSW□□□□□□□B...	MillQuadFeed cutter body	H058
TXWX03M□□□□B...	DoFeedTri cutter body	H043
TZF110...	TZF11 cutter body	H230
TZP120...	TZP12 cutter body	H226
TZP19□□□□R	TZP19 cutter body	H228
V		
VAD□□□□□□□S08-S-M...	TungMeister adapter for TungFlex connection	I104
VBB□□□□□□□-BG-02S...	TungMeister head	I078
VBB□□□□□□□-BM-02S...	TungMeister head	I078
VBB□□□□□□□-SG-02S...	TungMeister head	I079
VBD□□□□□□□-BG-02S...	TungMeister head	I078
VBD□□□□□□□-BG-04S...	TungMeister head	I079
VBE□□□□□□□-BG-04S...	TungMeister head	I079

Designation	Product name	Page
VBE□□□□□□□-BGA02S...	TungMeister head	I079
VBL□□□□□□□□□□-6S...	TungMeister head	I084
VBN□□□□□□□□□□-6S...	TungMeister head	I083
VBO□□□□□□□□□□-4S...	TungMeister head	I083
VBO□□□□□□□□□□-5S...	TungMeister head	I083
VCR□□□□□□□□□□-02S...	TungMeister head	I086
VCA□□□□□□□□□□A45-04S...	TungMeister head	I086
VCA□□□□□□□□□□A45-06S...	TungMeister head	I086
VCP□□□□□□□□□□-02S...	TungMeister head	I088
VCW118L05.0A45-02S06	TungMeister head	I086
VDP□□□□□□□□□□A30-02S...	TungMeister head	I090
VDP□□□□□□□□□□A30-02S...	TungMeister head	I090
VDP□□□□□□□□□□B30-02S...	TungMeister head	I090
VDS□□□□□□□□□□A45-02S...	TungMeister head	I088
VED□□□□□□□□□□R04S...	TungMeister head	I070
VED□□□□□□□□□□R05S...	TungMeister head	I070
VED□□□□□□□□□□R06S...	TungMeister head	I070
VED□□□□□□□□□□R04S...	TungMeister head	I067
VED□□□□□□□□□□R06S...	TungMeister head	I071
VED□□□□□□□□□□R08S...	TungMeister head	I072
VED□□□□□□□□□□R10S...	TungMeister head	I072
VED□□□□□□□□□□R10S...	TungMeister head	I072
VED□□□□□□□□□□R10S...	TungMeister head	I072
VED□□□□□□□□□□R10S...	TungMeister head	I072
VED250L37.0C50106S15	TungMeister head	I070
VEE□□□□□□□□□□C00-06S...	TungMeister head	I071
VEE□□□□□□□□□□C00-08S...	TungMeister head	I072
VEE□□□□□□□□□□C00-10S...	TungMeister head	I072
VEE□□□□□□□□□□C04S...	TungMeister head	I071
VEE□□□□□□□□□□C04S...	TungMeister head	I068
VEE□□□□□□□□□□C04S...	TungMeister head	I070
VEE□□□□□□□□□□C05S...	TungMeister head	I070
VEE□□□□□□□□□□C06S...	TungMeister head	I070
VEE□□□□□□□□□□C03S...	TungMeister head	I068
VEE□□□□□□□□□□C04S...	TungMeister head	I067
VEE□□□□□□□□□□C06S...	TungMeister head	I071
VEE□□□□□□□□□□C02S...	TungMeister head	I069
VEE□□□□□□□□□□C03S...	TungMeister head	I069
VEE□□□□□□□□□□C04S...	TungMeister head	I068
VEH□□□□□□□□□□C04S...	TungMeister head	I066
VER□□□□□□□□□□S-S	TungMeister adapter for ER collet connection	I104
VFM□□□□□□□□□□C06S...	TungMeister head	I075
VFX□□□□□□□□□□E04S...	TungMeister head	I076
VFX□□□□□□□□□□E06S...	TungMeister head	I076
VFX□□□□□□□□□□H04S...	TungMeister head	I076
VFX□□□□□□□□□□H04S...	TungMeister head	I076
VGC□□□□□□□□□□C03S...	TungMeister head	I091
VMT□□□□□□□□□□IS□□-...	TungMeister head	I096
VMT□□□□□□□□□□UN□□-...	TungMeister head	I096
VMT□□□□□□□□□□W□□-...	TungMeister head	I097
VRB□□□□□□□□□□C02S...	TungMeister head	I081
VRC□□□□□□□□□□C02S...	TungMeister head	I081
VRD□□□□□□□□□□C06S...	TungMeister head	I081
VSC□□□□□□□□□□□-...	TungMeister shank	I103
VSSD□□□□□□□□□□C-A	TungMeister shank	I101
VSSD□□□□□□□□□□S-A	TungMeister shank	I101
VSSD□□□□□□□□□□C	TungMeister shank	I100, I101
VSSD□□□□□□□□□□C-A	TungMeister shank	I101
VSSD□□□□□□□□□□S	TungMeister shank	I100, I101
VSSD□□□□□□□□□□S-A	TungMeister shank	I101
VSSD□□□□□□□□□□W-A	TungMeister shank	I100
VSSD□□□□□□□□□□W	TungMeister shank	I100
VSTD□□□□□□□□□□S	TungMeister shank	I103
VST□□□□□□□□□□A45-□S...	TungMeister head	I093
VST□□□□□□□□□□3S06	TungMeister head	I092
VST□□□□□□□□□□4S08	TungMeister head	I093
VST□□□□□□□□□□6S10	TungMeister head	I093
VTB□□□□□□□□□□R04-06S...	TungMeister head	I094
VTB135W2.00C15-06S05	TungMeister head	I094
VTR□□□□□□□□□□IS□□-□S...	TungMeister head	I097
VTR220L24W14-4S08	TungMeister head	I097
VTSD□□□□□□□□□□C	TungMeister shank	I102
VTSD□□□□□□□□□□S	TungMeister shank	I102
VTSD□□□□□□□□□□W-A	TungMeister shank	I103
W		
WCMT□□□□□□□□-D4	EVX insert	H225

Alphanumeric Index

Designation	Product name	Page
WDCN42ZFR-DIA	TMD4400R/LI, EMD4400RI, TGD4400-A, EGD4400 insert	H107, H111
WECN42ZFR-DIA	THE4000RIA insert	H172
WNGU□□□□□□TN-MJ	TungUniversalSlot insert	H188
WPAN42SFR	TGP4100RIA/BA insert	H112
WPAN42SFRS	TGP4100RIA/BA insert	H112
WPAN42ZFR	TGP4200R-A insert	H113
WPMT□□□□□□ZPR-DML	MillFeed insert	H053
WPMT□□□□□□ZPR-MH	MillFeed insert	H053
WPMT□□□□□□ZPR-ML	MillFeed insert	H053
WPMW□□□□□□ZPR	MillFeed insert	H053
WPMT080615ZSR	MillFeed insert	H053
WPMT090725ZSR	MillFeed insert	H053
WWCW13T3AF□R-WS	TungMill insert	H069
WWCW13T3AFFR-WD	TungMill insert	H069
WXHU0403□□R-MJ	DoMini-Mill insert	H200
WXMU0303ZER-MM	DoFeedTri insert	H043

X

XCET310404ER	ECC insert	H214
XVCT16□□□□R-AJ	Tung-AluMill insert	H161
XXMU□□□□PR-MJ	EVX insert	H225

Y

YDEN0603□□PDFR-D	TungSpeed-Mill insert	H093
YDEN0603PD□R-D	TungSpeed-Mill insert	H093
YDEN0603PDCR-LD	TungSpeed-Mill insert	H093
YDEN0603PDFR-BD	TungSpeed-Mill insert	H093
YDEN0603PDFR-WD	TungSpeed-Mill insert	H093
YDEN0905PDFR-BD	DPD09 / EDPD09 insert	H101
YDEN0905PDFR-D	DPD09 / EDPD09 insert	H101
YDEN0905PDFR-WD	DPD09 / EDPD09 insert	H101
YPEB12X3-□□□□R-D	TungSpeed-Mill insert	H095

Z

ZDMT□□□□-MJ	EBD insert	H209
ZFBM□□□□R□□-MJ	BallFinishNose insert	H195
ZFCBM□□□□R□□□-MM	BallFinishNose insert	H195
ZFRM□□□□R□□-MJ	BallFinishNose insert	H195
ZNCA□□□□FN	TBN1000 insert	H205
ZNCA1002FN2	TBN1000 insert	H205
ZNHU1003R□□0-MM	AddForceBarrel insert	H198
ZNMM□□□□EN	TBN1000 insert	H205
ZPCW□□□□-QBN	EBB insert	H208
ZPET□□□□-MJ	EBP insert	H207
ZRBM□□□□-MM	BallRoughNose insert	H202



JosS d.o.o.

Sokolska 45, 2000

Maribor, Slovenia

+386 2 421 57 20

+386 41 705 509

joss@joss.si

www.joss.si